



3rd/2nd Gen Intel® Core™
Mini-ITX

HR100-CRM

Mobile

QM67

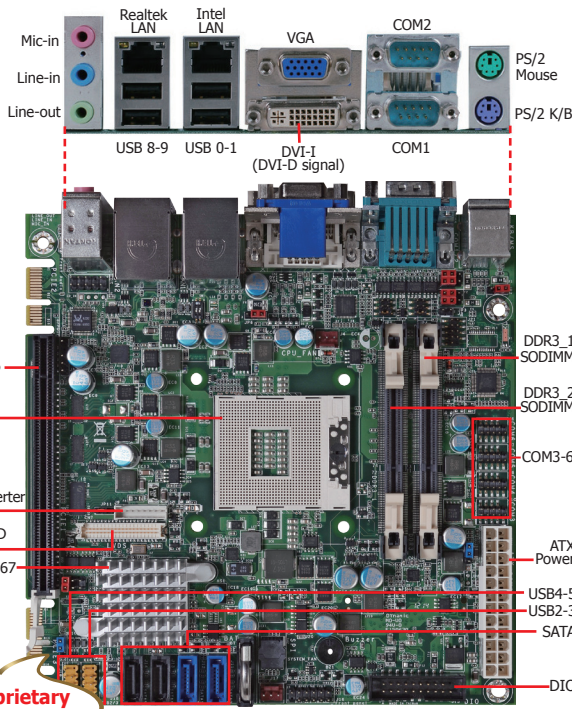

Two DFI Proprietary Extension Bus



Features

MEMORY	2 DDR3 SODIMM up to 16GB
EXPANSION	1 PCIe x16 2 DFI Proprietary Extension bus
DISPLAY OUTPUTS	1 DVI-I (DVI-D signal), 1 VGA, 1 LVDS
LAN	2 LAN
COM	6 COM
USB	8 USB 2.0
STORAGE	4 SATA: 2 SATA 3.0, 2 SATA 2.0 1 CF
DIO	8-bit DIO



6 Riser Cards for DFI Proprietary Extension Bus



H Series:

T Series:

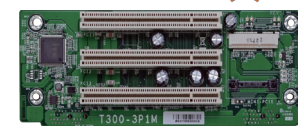
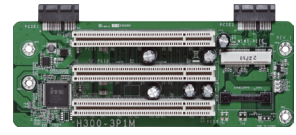

H300-3P1M

T300-3P1M

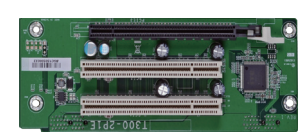
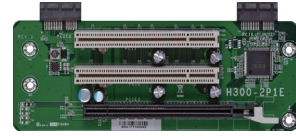

H300-2P1E

T300-2P1E

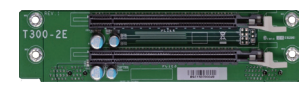

H300-2E

T300-2E

Mechanical Drawing

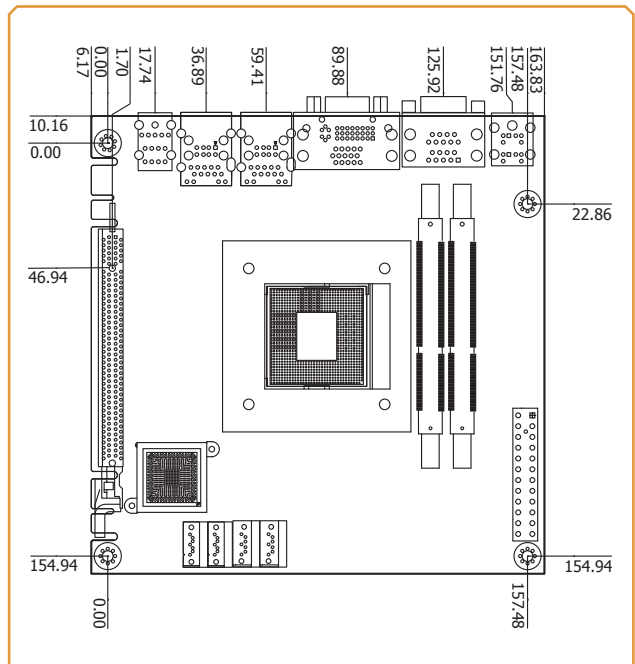

Block Diagram

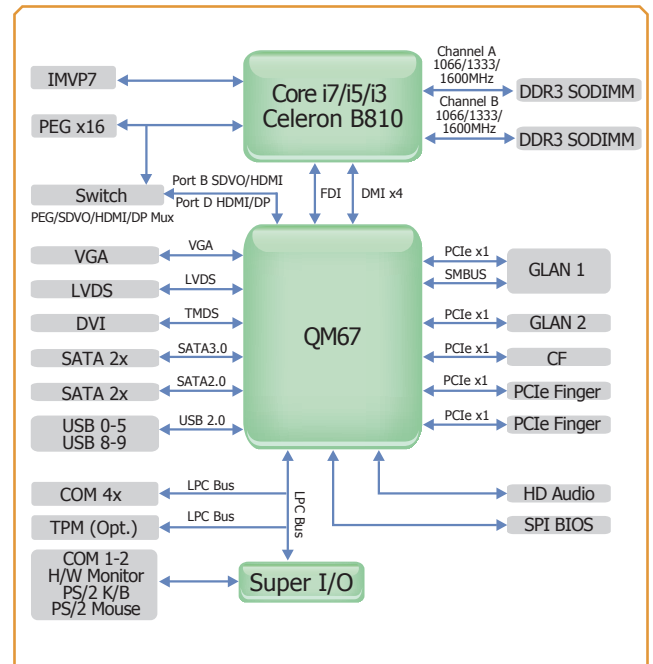

HR100-CRM

► Specifications

PROCESSOR

- Socket G2 988B for:
 - 3rd Generation Intel® Core™ processors (22nm process technology) (Rev. AG0 or later)
 - : Intel® Core™ i7-3610QE (6M Cache, up to 3.3 GHz); 45W
 - : Intel® Core™ i5-3610ME (3M Cache, up to 3.3 GHz); 35W
 - : Intel® Core™ i3-3120ME (3M Cache, 2.4 GHz); 35W
 - 2nd Generation Intel® Core™ processors (32nm process technology)
 - : Intel® Core™ i7-2710QE (6M Cache, up to 3.0 GHz); 45W
 - : Intel® Core™ i5-2510E (3M Cache, up to 3.1 GHz); 35W
 - : Intel® Core™ i3-2330E (3M Cache, 2.2 GHz); 35W
 - : Intel® Celeron® B810 (2M Cache, 1.6 GHz); 35W
- Intel® Advanced Vector Extensions (Intel® AVX) Instructions
- Intel® Turbo Boost Technology

CHIPSET

- Intel® QM67 Express chipset

SYSTEM MEMORY

- Two 204-pin DDR3 SODIMM sockets
- Supports DDR3 1333/1600MHz (3rd generation processors)
- Supports DDR3 1066/1333MHz (2nd generation processors)
- Supports dual channel memory interface
- Supports up to 16GB system memory
- DRAM device technologies: 1Gb, 2Gb and 4Gb DDR3 DRAM technologies are supported for x8 and x16 devices, unbuffered, non-ECC

EXPANSION SLOTS

- 1 PCIe x16 slot
 - Supports Gen 3.0 (3rd generation processors)
 - Supports Gen 2.0 (2nd generation processors)
 - Switchable with SDVO/HDMI/DP
 - Configurations (supported only via a riser card):
 - : One x8 (GFX) and two x4 (I/O)
 - : Two x8 (GFX, I/O)
 - : One x16 (GFX, I/O)
- 2 DFI Proprietary Extension bus for PCIe/PCI expansion
- 1 CompactFlash socket (optional)

ONBOARD GRAPHICS FEATURES

- Intel® HD Graphics
- Display ports: DVI-D (ASMedia 1442), LVDS and VGA
- DVI: resolution up to 1920x1200 @ 60Hz
- LVDS: Single Channel - 18/24-bit; Dual Channel: 36/48-bit, resolution up to 1920x1200 @ 60Hz
- VGA: resolution up to 2048x1536 @ 75Hz
- Supports 6 Graphics Execution Units (EUs)
- Intel® Clear Video Technology
- DirectX Video Acceleration (DXVA) support for accelerating video processing

ONBOARD AUDIO FEATURES

- Realtek ALC262 2-channel High Definition Audio
- High performance DACs with 100dB SNR
- ADCs with 90dB SNR
- Two stereo DACs support 24-bit PCM format for stereo audio playback
- Three stereo ADCs support 20-bit PCM format for multiple input streaming
- S/PDIF audio interface

ONBOARD LAN FEATURES

- Intel® 82579LM with iAMT7.0 Gigabit Ethernet Phy
- Realtek RTL8111DL PCI Express Gigabit Ethernet controller
- Integrated 10/100/1000 transceiver
- Fully compliant with IEEE 802.3, IEEE 802.3u, IEEE 802.3ab

SERIAL ATA (SATA) INTERFACE

- 4 Serial ATA ports
 - 2 SATA 2.0 ports with data transfer rate up to 3Gb/s
 - 2 SATA 3.0 ports with data transfer rate up to 6Gb/s
- Integrated Advanced Host Controller Interface (AHCI) controller
- Supports RAID 0/1/5/10

COMPACTFLASH INTERFACE

- JMicron JMB368 PCI Express to PATA host controller
- DMA mode: Ultra ATA up to 100MB/s
- PIO mode: up to 16MB/s

INTEL ACTIVE MANAGEMENT TECHNOLOGY (AMT)

- Supports iAMT7.0
- Out-of-band system access
- Remote troubleshooting and recovery
- Hardware-based agent presence checking
- Proactive alerting
- Remote hardware and software asset tracking

► Packing List

• 1 HR100-CRM motherboard
• 2 Serial ATA data cables
• 2 Serial ATA power cables
• 2 USB cables
• 1 Bracket mounted with a COM port cable
• 1 I/O shield
• 1 DVD

REAR PANEL I/O PORTS

- 1 mini-DIN-6 PS/2 mouse port
- 1 mini-DIN-6 PS/2 keyboard port
- 2 DB-9 serial ports
 - Supports RS232/422/485
 - Pins 1 and 9 of RS232 functions as RS232 signal or power (selectable via jumper)
- 1 DB-15 VGA port
- 1 DVI-I port (DVI-D signal)
- 2 RJ45 LAN ports
- 4 USB 2.0/1.1 ports
- Mic-in, line-in and line out jacks

I/O CONNECTORS

- 2 connectors for 4 external USB 2.0/1.1 ports
- 4 connectors for 4 external RS232 serial ports
- 1 LVDS LCD panel connector
- 1 LCD/inverter power connector
- 1 8-bit Digital I/O connector
- 1 front audio connector for line-out and mic-in jacks
- 1 S/PDIF connector
- 4 Serial ATA ports
- 1 24-pin ATX power connector
- 1 chassis intrusion connector
- 1 front panel connector
- 2 fan connectors

TRUSTED PLATFORM MODULE (TPM) - optional

- Provides a Trusted PC for secure transactions
- Provides software license protection, enforcement and password protection

BIOS

- AMI BIOS
- 64Mbit SPI BIOS

ENERGY EFFICIENT DESIGN

- Supports ErP Lot6 power saving (optional)
- Supports ACPI
- System Power Management
- Wake-On-Events include:
 - Wake-On-PS/2 KB/Mouse
 - Wake-On-USB KB/Mouse
 - Wake-On-LAN
 - RTC timer to power-on the system
- CPU stopped clock control
- AC power failure recovery

DAMAGE FREE INTELLIGENCE

- Monitors CPU/system temperature and overheat alarm
- Monitors VCore/5V/1.05V/1.5V/12V/3.3V/VBAT voltages and failure alarm
- Monitors CPU/system fan speed and failure alarm
- Read back capability that displays temperature, voltage and fan speed
- Watchdog timer function

POWER CONSUMPTION

- 64.68 W with i7-2710QE at 2.1GHz and 2x 4GB DDR3 SODIMM

OS SUPPORT

- Windows XP Professional x86 & SP3 (32-bit)
- Windows XP Professional x64 & SP2 (64-bit)
- Windows 7 Ultimate x86 & SP1 (32-bit)
- Windows 7 Ultimate x64 & SP1 (64-bit)
- Windows 8 Enterprise x86 (32-bit)
- Windows 8 Enterprise x64 (64-bit)

TEMPERATURE

- 0°C to 60°C

HUMIDITY

- 10% to 90%

DIMENSIONS

- Mini-ITX form factor
- 170mm (6.7") x 170mm (6.7")

CERTIFICATION

- CE, FCC Class B, UL, RoHS

► Optional Items

• USB port cable
• Serial ATA data cable
• Serial ATA power cable
• COM port cable
• I/O shield