



User Manual

ARK-3534

Fanless Embedded Box PC

ADVANTECH

Enabling an Intelligent Planet

Attention!

Please note:

This package contains a hard-copy user manual in Chinese for China CCC certification purposes. There is an English user manual that can be downloaded from the Advantech website. Please disregard the Chinese hard copy user manual if the product is not to be sold and/or installed in China.

Copyright

The documentation and the software included with this product are copyrighted 2024 by Advantech Co., Ltd. All rights are reserved. Advantech Co., Ltd. reserves the right to make improvements in the products described in this manual at any time without notice.

No part of this manual may be reproduced, copied, translated, or transmitted in any form or by any means without the prior written permission of Advantech Co., Ltd. Information provided in this manual is intended to be accurate and reliable. However, Advantech Co., Ltd. assumes no responsibility for its use, nor for any infringements of the rights of third parties, which may result from its use.

Acknowledgments

Award is a trademark of Award Software International, Inc.

VIA is a trademark of VIA Technologies, Inc.

IBM, PC/AT, PS/2, and VGA are trademarks of International Business Machines Corporation.

Intel® and Pentium® are trademarks of Intel Corporation.

Microsoft Windows® is a registered trademark of Microsoft Corp.

RTL is a trademark of Realtek Semiconductor Co., Ltd.

ESS is a trademark of ESS Technology, Inc.

UMC is a trademark of United Microelectronics Corporation.

SMI is a trademark of Silicon Motion, Inc.

Creative is a trademark of Creative Technology, Ltd.

Chrontel is a trademark of Chrontel, Inc.

All other product names or trademarks are properties of their respective owners.

For more information about this and other Advantech products, please visit our website at:

<http://www.advantech.com/>

For technical support and service, please visit our support website at:

<http://advantech.com/support>

Product Warranty (2 Years)

Advantech warrants to you, the original purchaser, that each of its products will be free from defects in materials and workmanship for two years from the date of purchase.

This warranty does not apply to any products which have been repaired or altered by persons other than repair personnel authorized by Advantech, or which have been subject to misuse, abuse, accident, or improper installation. Advantech assumes no liability under the terms of this warranty as a consequence of such events.

Because of Advantech's high quality-control standards and rigorous testing, most of our customers never need to use our repair service. If an Advantech product is defective, it will be repaired or replaced at no charge during the warranty period. For out-of-warranty repairs, you will be billed according to the cost of replacement materials, service time and freight. Please consult your dealer for more details.

If you think you have a defective product, follow these steps:

1. Collect all the information about the problem encountered. (For example, CPU speed, Advantech products used, other hardware and software used, etc.) Note anything abnormal and list any onscreen messages you get when the problem occurs.
2. Call your dealer and describe the problem. Please have your manual, product, and any helpful information readily available.
3. If your product is diagnosed as defective, obtain an return merchandise authorization (RMA) number from your dealer. This allows us to process your return more quickly.
4. Carefully pack the defective product, a fully-completed Repair and Replacement Order Card and a photocopy proof of purchase date (such as your sales receipt) in a shippable container. A product returned without proof of the purchase date is not eligible for warranty service.
5. Write the RMA number visibly on the outside of the package and ship it prepaid to your dealer.

Declaration of Conformity

FCC Class B

Note: This equipment has been tested and found to comply with the limits for a Class B digital device, pursuant to part 15 of the FCC Rules. These limits are designed to provide reasonable protection against harmful interference in a residential installation.

This equipment generates, uses, and can radiate radio frequency energy and, if not installed and used in accordance with the instructions, may cause harmful interference to radio communications. However, there is no guarantee that interference will not occur in a particular installation. If this equipment does cause harmful interference to radio or television reception, which can be determined by turning the equipment off and on, the user is encouraged to try to correct the interference by one or more of the following measures:

- Reorient or relocate the receiving antenna.
- Increase the separation between the equipment and receiver.
- Connect the equipment into an outlet on a circuit different from that to which the receiver is connected.
- Consult the dealer or an experienced radio/TV technician for help.

Technical Support and Assistance

1. Visit the Advantech website at www.advantech.com/support where you can find the latest information about the product.
2. Contact your distributor, sales representative, or Advantech's customer service center for technical support if you need additional assistance. Please have the following information ready before you call:
 - Product name and serial number
 - Description of your peripheral attachments
 - Description of your software (operating system, version, application software, etc.)
 - A complete description of the problem
 - The exact wording of any error messages

Warnings, Cautions, and Notes

Warning! *Warnings indicate conditions, which if not observed, can cause personal injury!*



Caution! *Cautions are included to help you avoid damaging hardware or losing data, e.g.,*



There is danger of a new battery exploding if it is incorrectly installed. Do not attempt to recharge, force open, or heat the battery. Replace the battery only with the same or equivalent type recommended by the manufacturer. Discard used batteries according to the manufacturer's instructions.

Note! *Notes provide optional additional information.*



Packing List

Before installation, please ensure the following items have been shipped:

- 1 x ARK-3534 Unit
- 1 x User Manual (Simplified Chinese)
- 1 x China RoHS
- 1 x Desk mounting kit
- 1 x WISE-DeviceOn
- 1 x McAfee Application Control Lite / Acronis Backup 11.7 for Windows PC

Ordering Information

Part No.	CPU	DDR5	LAN	HDMI	Optional 3rd display module	RS-232	RS-232/422/485	USB	M.2 B-Key	SIM	M.2 E-Key	DC Input	Expansion
ARK-3534B-00A1	LGA1700 Socket Type	Up to 64GB	2	2	1	2	4	8	1	1	1	9-36V DC	PCI ex4+PCI ex16
ARK-3534C-00A1	LGA1700 Socket Type	Up to 64GB	2	2	1	2	4	8	1	1	1	9-36V DC	PCI ex16+2PCI
ARK-3534D-00A1	LGA1700 Socket Type	Up to 64GB	4	2	1	2	4	8	1	1	1	9-36V DC	PCI ex4+2PCI+PCI ex16

Note! CPU/Memory/Storage and operating system included by request.



Optional Items for the Default SKU

Part Number	Description
96PSA-A230W24P4-3	AC to DC adapter, DC 24V 230W, -20 ~ 60°C (-4 ~ 140°F)
1702002600	Power cable 3-pin 183 cm (6 ft), USA type
1702002605	Power cable 3-pin 183 cm (6 ft), EU type
1702031801	Power cable 3-pin 183 cm (6 ft), UK type
1700000237	Power cable 3-Pin 183 cm (6 ft), PSE type

Safety Instructions

1. Read these safety instructions carefully.
2. Retain this user manual for future reference.
3. Disconnect the equipment from all AC outlets before cleaning. Use only a damp cloth for cleaning. Do not use liquid or spray detergent.
4. For pluggable equipment, the power outlet should be near the equipment and easily accessible.
5. Protect the equipment from humidity.
6. Place the equipment on a reliable surface during installation. Dropping or letting the equipment fall may cause damage.
7. The power outlet sockets should have grounded connections.
8. Position the power cord away from high-traffic areas. Do not place anything over the power cord.
9. All cautions and warnings on the equipment should be noted.
10. If the equipment is not used for a long time, disconnect the equipment from the power source to avoid damage from transient over-voltage.
11. Never pour liquid into an opening as this can cause fire or electrical shock.
12. Never open the equipment. For safety reasons, only qualified service personnel should open the equipment.
13. If one of the following occurs, have the equipment checked by service personnel:
 - The power cord or plug is damaged.
 - Liquid has penetrated into the equipment.
 - The equipment has been exposed to moisture.
 - The equipment is malfunctioning or does not operate according to the user manual.
 - The equipment has been dropped and damaged.
 - The equipment shows obvious signs of breakage.
14. Do not leave the equipment in an environment with a storage temperature of below -40°C (-40°F) or above 85°C (185°F) as this may cause damage. The equipment should be stored in a controlled environment.
15. Any unverified component may cause unexpected damage. To ensure correct installation, always use the components (e.g., screws) provided in the accessory box.
16. **CAUTION:** The equipment is equipped with a battery-powered real-time clock circuit. There is a risk of explosion if a battery is incorrectly replaced. Replace only with same or equivalent type as recommended by the manufacturer. Discard all used batteries according to the manufacturer's instructions.
17. Always disconnect the power cord from the chassis before manually handling the hardware. Do not implement connections or configuration changes while the device is powered on. Sudden power surges may damage sensitive electronic components.
18. In accordance with IEC 704-1:1982 specifications, the sound pressure level at the operator's position should not exceed 70 dB (A).
19. **DISCLAIMER:** These instructions are provided according to IEC 704-1 specifications.
Advantech disclaims all responsibility for the accuracy of any statements contained herein.
20. Use a power cord connected to a socket-outlet with a grounded connection.
21. This product is intended to be supplied by a UL-listed power supply suitable for use at minimum Tma 60°C (140°F) whose output meets ES1 (or SELV) and out-

put is rated: 9-36Vdc, 25.5-6.3A. Please contact Advantech for further information.

22. RESTRICTED ACCESS AREA: The equipment should only be installed in a Restricted Access Area.

Consignes de Sécurité

1. Veuillez lire attentivement ces instructions de sécurité.
2. Veuillez conserver ce manuel de l'utilisateur pour référence ultérieure.
3. Veuillez débrancher cet équipement de la prise secteur avant le nettoyage. Utilisez un chiffon humide. Ne pas utiliser de détergent liquide ou pulvérisé pour le nettoyage. Utilisez une feuille ou un chiffon humide pour le nettoyage.
4. Pour les équipements enfichables, la prise de courant doit être à proximité de l'équipement et doit être facilement accessible.
5. S'il vous plaît garder cet équipement de l'humidité.
6. Posez cet équipement sur une surface fiable lors de l'installation. Une chute ou une chute pourrait causer des blessures.
7. La prise de courant doit avoir une connexion mise à la terre.
8. Placez le cordon d'alimentation de sorte que personne ne puisse marcher dessus.
Ne placez rien sur le cordon d'alimentation.
9. Tous les avertissements et mises en garde sur l'équipement doivent être notés.
10. Si l'appareil n'est pas utilisé pendant une longue période, débranchez-le du secteur pour ne pas être endommagé par une surtension transitoire.
11. Ne jamais verser de liquide dans les ouvertures de ventilation; Cela pourrait provoquer un incendie ou un choc électrique.
12. N'ouvrez jamais l'équipement. Pour des raisons de sécurité, seul le personnel de maintenance qualifié doit ouvrir l'équipement.
13. Si l'une des situations suivantes se présente, faites vérifier le matériel par le personnel de service:
 - Le cordon d'alimentation ou la fiche est endommagé.
 - Un liquide a pénétré dans l'appareil.
 - L'équipement a été exposé à l'humidité.
 - L'équipement ne fonctionne pas bien ou vous ne pouvez pas le faire fonctionner conformément au manuel d'utilisation.
 - Equipment L'équipement est tombé et a été endommagé.
 - Equipment L'équipement présente des signes évidents de rupture.
14. Ne laissez pas cet équipement dans un environnement où la température de stockage peut être inférieure à -40°C (-40°F) ou supérieure à 85°C (185°F). Cela pourrait endommager l'équipement. L'équipement doit être dans un environnement contrôlé.
15. Tout composant non vérifié peut causer des dommages inattendus. Pour garantir une installation correcte, veuillez toujours utiliser les composants (ex. Vis) fournis avec la boîte d'accessoires.
16. ATTENTION: L'ordinateur est équipé d'un circuit d'horloge temps réel alimenté par batterie. Il y a un risque d'explosion si la batterie est remplacée de manière incorrecte. Remplacez uniquement avec le même type ou un type équivalent recommandé par le fabricant. Jetez les piles usagées conformément aux instructions du fabricant.
17. Débranchez toujours complètement le cordon d'alimentation de votre châssis lorsque vous utilisez du matériel. Ne faites pas de connexion quand l'appareil

est sous tension. Les composants électroniques sensibles peuvent être endommagés par des surtensions soudaines.

18. Niveau de pression acoustique au poste de l'opérateur selon la norme CEI 704-1: 1982 n'est pas supérieur à 70 dB (A).
19. **AVERTISSEMENT:** Cet ensemble d'instructions est donné conformément à la norme CEI 704-1. Advantech décline toute responsabilité quant à l'exactitude des déclarations contenues dans ce.
20. Au moyen d'un cordon d'alimentation connecté à une prise de courant avec mise à la terre.
21. Ce produit est destiné à être alimenté par un bloc d'alimentation homologué UL adapté à une utilisation à T_{ma} 60 degrés C min. dont la sortie est conforme à ES1 (ou SELV) et dont la sortie est nominale: 9-36Vdc, 25.5-6.3A, si besoin d'aide supplémentaire, veuillez contacter Advantech pour plus d'informations.
22. **ZONE D'ACCÈS RESTREINT:** L'équipement ne doit être installé que dans une zone d'accès restreint.

Contents

Chapter 1 General Introduction1

1.1	Introduction	2
1.2	Product Features.....	3
	1.2.1 General	3
	1.2.2 Display	3
	1.2.3 Ethernet	3
1.3	Chipset.....	4
	1.3.1 Functional Specifications	4
	1.3.2 SUSI 4.0.....	5
1.4	Mechanical Specifications.....	6
	1.4.1 Dimensions	6
	1.4.2 Weight.....	7
1.5	Power Requirements.....	7
	1.5.1 System Power.....	7
1.6	Operating Environment Specifications	8
	1.6.1 Operating Temperature.....	8
	1.6.2 Relative Humidity	8
	1.6.3 Storage Temperature.....	8
	1.6.4 Safety.....	8
	1.6.5 EMC.....	8

Chapter 2 Hardware Configuration.....9

2.1	Introduction	10
2.2	Jumpers	10
	2.2.1 Jumper Description	10
	2.2.2 Jumper List	10
	Table 2.1: Jumper List.....	10
	2.2.3 Jumper Locations.....	11
	Figure 2.1 Jumper Layout.....	11
	2.2.4 Jumper Settings.....	11
2.3	Connectors.....	14
	2.3.1 ARK-3534 External I/O Locations	14
	Figure 2.2 ARK-3534 Front and Rear I/O Connector Diagram..	14
	Figure 2.3 COM Connector.....	14
	Table 2.2: COM Connector Pin Assignments.....	14
	Table 2.3: COM Connector Pin Assignments	15
	Figure 2.4 Ethernet Connector	15
	Table 2.4: Ethernet Connector Pin Assignments.....	15
	Figure 2.5 HDMI Receptacle Connector.....	16
	Table 2.5: HDMI Connector Pin Assignments	16
	Figure 2.6 DIO Connector.....	16
	Table 2.6: DIO Connector Pin Assignments	16
	Figure 2.7 Power ON/OFF Button	17
	Figure 2.8 LED Indicators	17
	Table 2.7: USB 2.0 Pin Definitions	18
	Figure 2.9 USB 3.2 Gen 1/2 Connector.....	18
	Table 2.8: USB 3.2 Gen1/2 Connector Pin Assignments	18
	Figure 2.10 Remote Switch Connector	19
	Figure 2.11 Phoenix Terminal Connector	19
	Table 2.9: Phoenix Terminal Connector	19
2.4	Installation	20
	2.4.1 CPU/Memory Installation	20
	2.4.2 External HDD/SSD Installation	21

2.4.3	Mounting Kit Installation.....	22
2.4.4	M.2 Module / Mini PCIe Module / Internal SIM Card Slot Installation 23	
2.4.5	Attaching the Thermal pad.....	24

Chapter 3 BIOS Settings 25

3.1	Introduction	26
3.2	Entering the Setup	27
3.2.1	Main Setup.....	27
3.2.2	Advanced BIOS Features Setup.....	28
3.2.3	Chipset Configuration	75
3.2.4	Security.....	105
3.2.5	Boot	107
3.2.6	Save & Exit	108
3.2.7	MEBx	109

Chapter 1

General Introduction

This chapter details background information on the ARK-3534 series.

1.1 Introduction

Advantech's ARK-3534 is an intelligent, high-performance, fanless desktop system powered by 12/13th Gen. Intel® Core™ LGA1700 and Core i3/i5/i7/i9 65W processors. ARK-3534 supports a maximum 65W processor and broad temperature ranges (-20 ~ 60°C / -4 ~ 140°F). It also provides multiple I/O — up to 8 x COM, 4 x GbE, 4 x USB 3.2, 4 x USB 3.0, 2 x CAN bus (optional), 1 x M.2 (B-Key), 1 x M.2 (E-Key), 1 x Line-Out, TPM 2.0 (optional) and 3 x 2.5" SATA III hard drive bays.

Rugged Multi-Functional Design

ARK-3534 adopts an advanced thermal design for its desktop processor solution. All models are fanless and deliver several unique features. These include wide operating temperatures (-20 ~ 60°C / -4 ~ 140°F), diverse expandability options, and structural strengthening. It supports diverse I/O interfaces — up to 4 x Intel® GbE, 4 x USB 3.2, 4 x USB 3.0, 2 x CAN bus (optional), 3 x 2.5" HDD, 1 x M.2 (B-Key), 1 x M.2 (E-Key) 4 x RS-232/422/485, and 4 x RS-232 COM ports.

Built-in Intelligent Management Tools — Advantech SUSI API and WISE-DeviceOn

Advantech SUSI API provides a valuable suite of programmable APIs such as multi-level watchdog, hardware monitoring, system restoration, and other user-friendly interfaces.

SUSI API is an intelligent self-management cross platform tool that monitors the system's status for problems and takes action in the event of abnormalities. SUSI API offers a boot-up guarantee in critical, low-temperature environments so systems can automatically recover when voltages dip. SUSI API makes the entire system more reliable and intelligent. ARK-3534 also supports Advantech's own WISE-DeviceOn software which provides easy remote management so users can monitor, configure, and control a large number of terminals to make maintenance and system recovery simpler.

1.2 Product Features

1.2.1 General

- **CPU:** 12th Gen. Intel® Xeon® W (support by R680E PCH) and Core™ i3/i5/i7/i9 (LGA1700) desktop processor (up to 65W)
- **System Chipset:** Intel® R680E, H610E
- **BIOS:** AMI EFI 256 Mbit
- **System Memory:** DDR5 4800MHz up to 64GB
- **Watchdog Timer:** Single-chip watchdog 255-level interval timer, set up by software
- **I/O Interface:** 4 x RS232/422/485, 2 x RS232 (2 x RS-232 optional)
- **USB:** 4 x USB 3.2, 4 x USB 3.0 (R680E); 4 x USB 3.2, 4 x USB 2.0 (H610E)
- **Audio:** High Definition Audio (HD), and Line-out/Mic-in
- **Storage:** 3 x 2.5" HDD drive bays (15mm/ 0.59 in height) and 1 x M.2 B-Key NVME (PCIe x2)
- **Expansion Interface:**
 - 1 x M.2 (B-Key for NVME, SATA, LTE/5G modules)
 - 1 x M.2 (E-Key for Wi-Fi, suggested installation at Advantech manufacturing)
 - Add-on Card Slot: 3534B for 1 x Slot PCIe x4 + 1 x Slot PCIe x16, 3534C for 1 x Slot PCIe x16 + 2 Slot PCI, 3534D for 1 x Slot PCIe x4 + 2 x Slot PCI + 1 x Slot PCIe x16
- **TPM:** TPM 2.0 (optional)

1.2.2 Display

- **Controller:** According to customer-specified CPU selection
- **Resolution:**
 - 2 x HDMI: supports HDMI 2.0, 4096 x 2160 @ 60 Hz
- **Triple Displays:**
 - 2 x HDMI + DVI-D
 - 2 x HDMI + DP
 - 2 x HDMI + HDMI

1.2.3 Ethernet

- **Chipset:**
 - LAN1 Intel® i219LM
 - LAN2 Intel® i225V (H610E); LAN2/3/4 Intel® i225LM (R680E)

1.3 Chipset

1.3.1 Functional Specifications

1.3.1.1 Processor

- Processor Supports 12th Gen. Intel® LGA1700 processor (up to 65W)
- Memory Supports DDR5 4800 MHz up to 64GB
- 2 x 262-pin SODIMM socket type

1.3.1.2 Chipset

Internal Graphics Features

- DirectX 12, OpenGL 4.5
- HDMI + HDMI
- Intel® Display Power Saving Technology 6.0

Video Accelerator

- HW-Accelerated Media Decode: H.265/HEVC, H.264/MPEG-4 AVC, MPEG-2, VC-1/WMV9, JPEG/MJPEG, VP8, and VP9
- HW-Accelerated Media Encode: H. H.265/HEVC, H.264/MPEG-4 AVC, MPEG-2, JPEG/MJPEG, and VP8

SATA Interface

- Supports several optional selections of Serial ATA III
- Supports SATA data transfer rates of up to 6 Gb/s
- Integrated AHCI controller

USB Interface

- 1 x XHCI Host Controller, supporting SuperSpeed USB 3.2 Gen1/Gen2
- 1 x EHCI Host Controllers, supporting HighSpeed USB 2.0 ports
- Supports wake-up from sleep states S3
- USB1/2 Maximum 1.9A

Power Management

- Supports ACPI
- ACPI-defined power states (processor driven C states)
- ACPI Power Management Timer
- SMI# generation

1.3.1.3 Others

Serial Ports

- Up to 8 x serial ports
- Supports IRQ Sharing among serial ports under Microsoft
- COM3, COM4, COM5, COM6: RS-232/422/485
- COM1, COM2 (Optional COM7, COM8): RS-232

Ethernet

LAN1 Intel i219LM, LAN2 Intel i225-V (H610E), LAN2/3/4 Intel i225-LM (R680E)

- I219LM Support up to 10/100/1000 Mbps
- I225V/I225LM Support up to 10/100/1000/2500Mbps
- LAN Connectors: Phone Jack RJ-45 8P 90D (F)

Audio

Audio Codec: ALC888S-VD2-GR

- Compliant with HD Audio specifications
- Supports 16-/20-/24-bit DAC and 16-/20-/24-bit ADC resolution
- Supports: Speaker-out, Mic-in
- Audio Connectors: 1 x headphone jack *

Battery Backup Battery 3V/210 mAh with wire x 1

TPM TPM 2.0

1.3.2 SUSI 4.0

- SUSI API
- Sequence Control Supported
- DIO 16-bit programmable DIO
- Watchdog Timer Multi-level WDT
- Programmable 1-255 sec/min
- Hardware Monitor CPU Temperature / input Current / input Voltage
- System Information Running HR / Boot record
- 2 x CAN bus supported

1.4 Mechanical Specifications

1.4.1 Dimensions

ARK-3534B/ARK-3534C

(W x H x D) 156 x 204 x 230 mm / 6.14 x 8.03 x 9.05 in

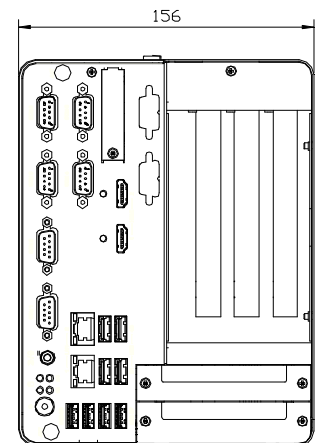
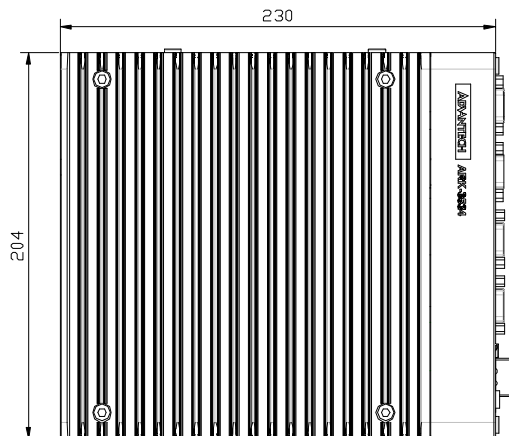
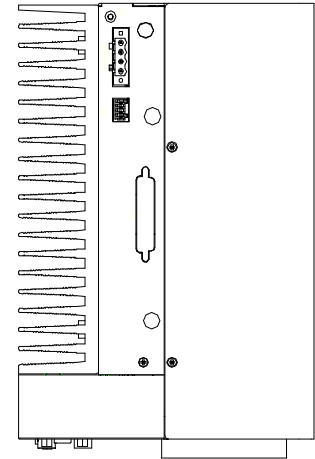
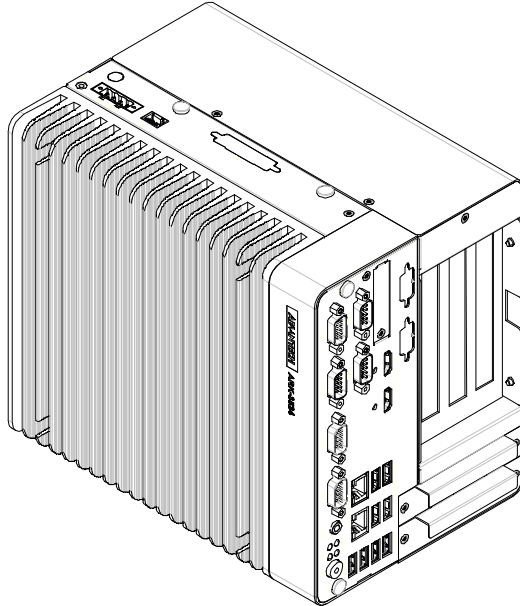

ARK-3534D

(W x H x D) 197.2 x 204 x 230 mm / 7.7 x 8.03 x 9.05 in

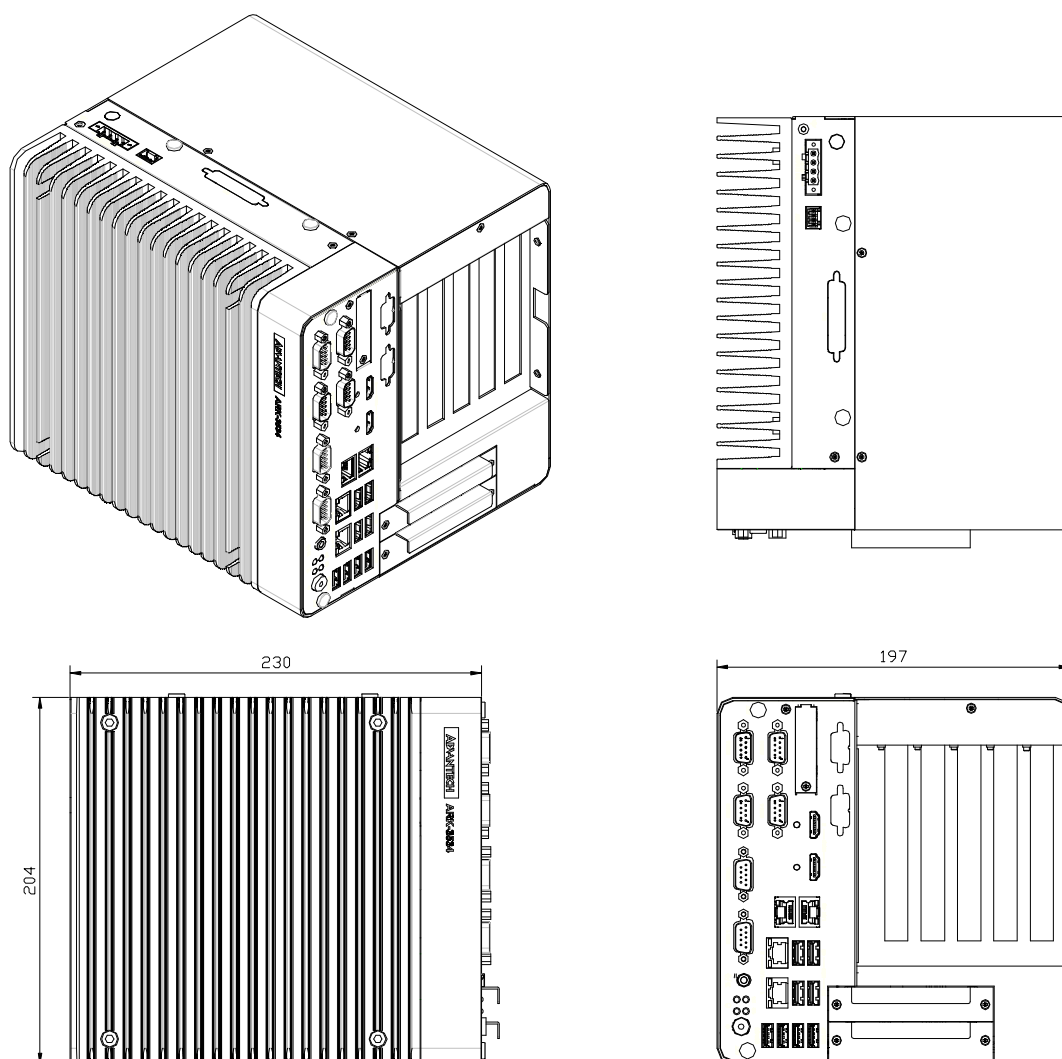
**1.4.2 Weight**

ARK-3534B/ARK-3534C: 5.7 kg (12.5 lb)

ARK-3534D: 6.41 kg (14.1 lb)

1.5 Power Requirements**1.5.1 System Power**

- **Minimum Power Input:** 9 ~ 36VDC
- **Optional Adapter:**
 - 150W @19V/7.89A power adapter (optional)
 - 230W @ 24V/9.58A power adapter (optional)

1.6 Operating Environment Specifications

1.6.1 Operating Temperature

- With extended peripherals: -20 ~ 60°C (-4 ~ 140°F) with 0.7m/s air-flow

1.6.2 Relative Humidity

- 95% @ 40°C (104°F) (non-condensing)

1.6.3 Storage Temperature

- -40 ~ 85°C (-40 ~ 185°F)

1.6.4 Safety

- UL, CB, CCC, BSMI

1.6.5 EMC

- CE/FCC Class B, CCC, BSMI

Chapter 2

Hardware
Configuration

2.1 Introduction

The following sections show the internal jumper settings and the external connector pin assignments for different applications.

2.2 Jumpers

2.2.1 Jumper Description

You may configure ARK-3534 to match the needs of your application by setting jumpers. A jumper is a metal bridge used to close an electric circuit. It consists of two metal pins and a small metal clip (often protected by a plastic cover) that slides over the pins to connect them. To close a jumper, you connect the pins with the clip. To open a jumper, remove the clip. Sometimes a jumper will have three pins, labeled 1, 2, and 3. In this case you would connect either pins 1 and 2, or 2 and 3.

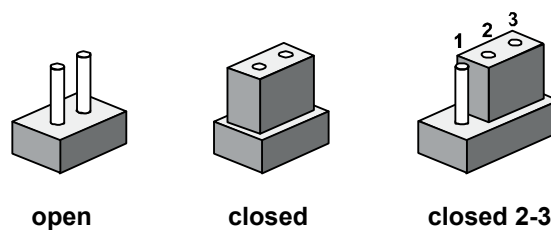

The jumper settings are schematically depicted in this manual as follows.

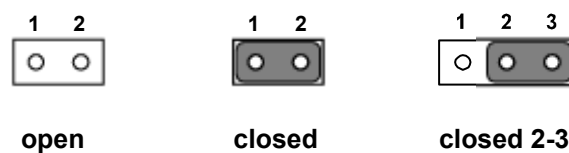

A pair of needle-nose pliers may be helpful when working with jumpers. If you have any doubts about the best hardware configuration for your application, contact your local distributor or sales representative before you make any changes. Generally, you simply need a standard cable to make most connections.

2.2.2 Jumper List

Table 2.1: Jumper List

CN22	Auto Power On Setting (MB)
CLCMOS1	Clear CMOS (MB)
ERP1	Power saving mode (MB)
CN20	M.2 B-Key Power select (MB)
J_CFG5	PCIe x16 Bifurcation Setting (MB)
J1(AMO-I028)	COM3 RI power setting (on AMO-I028)

2.2.3 Jumper Locations

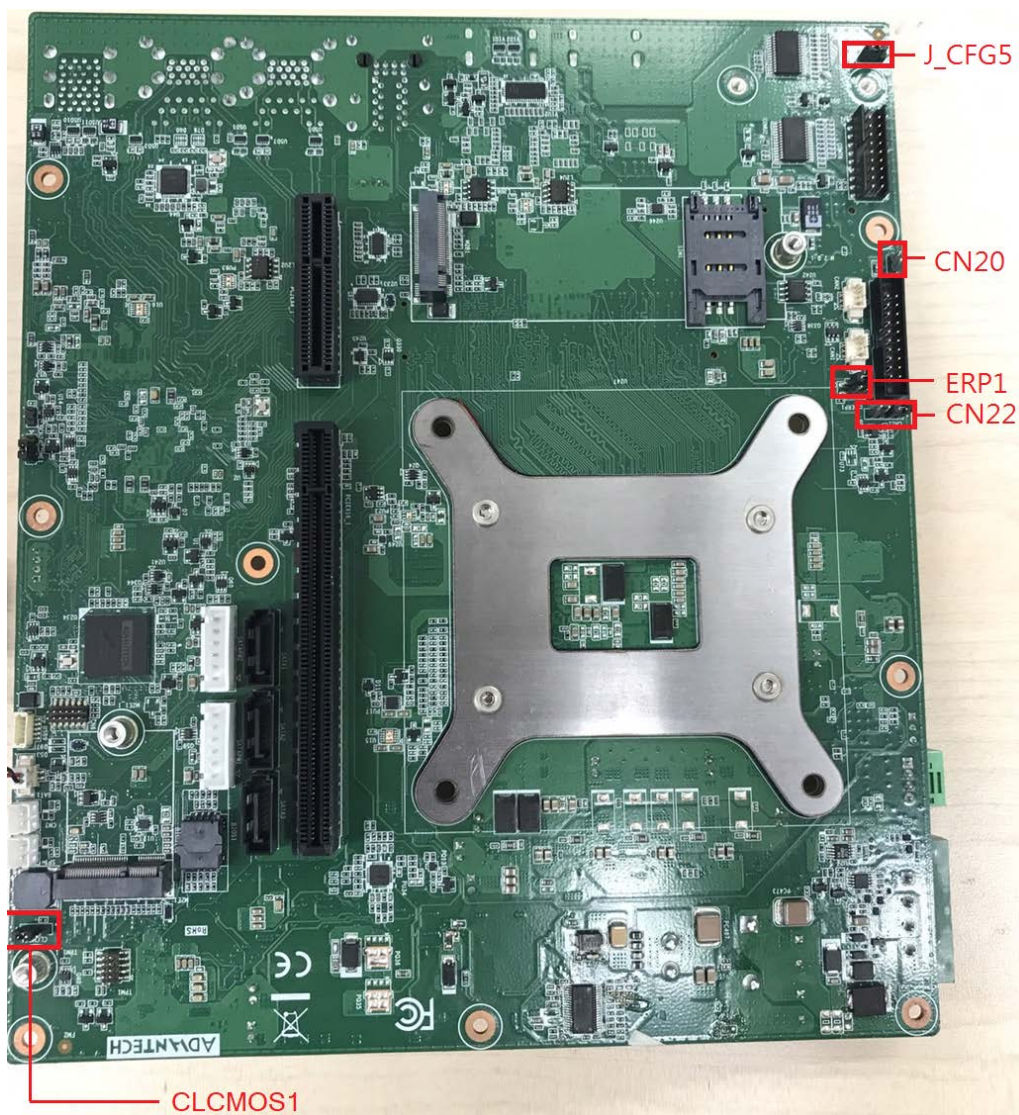

Figure 2.1 Jumper Layout

2.2.4 Jumper Settings

2.2.4.1 Auto Power On Settings for CN22

CN22 Auto Power On Setting	
Part Number	1653004101
Footprint	HD_4x1P_79_D
Description	PIN HEADER 4x1P 2.0mm 180D(M) DIP 21N12050
Setting	Function
(3-4)	Auto Power On
(1-2)	Power Button for Power On (Default)



2.2.4.2 Clear CMOS Settings for CLCMOS1

CLCMOS1 Clear CMOS Setting

Part Number	1653003101
Footprint	HD_3x1P_79_D
Description	PIN HEADER 3x1P 2.0 mm 180D(M) DIP 2000-13 WS
Setting	Function
(1-2)	Normal Operation (Default)
(2-3)	Clear CMOS

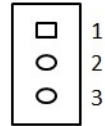

2.2.4.3 M.2 B-Key Power Settings for CN20

CN20 Power Setting

Part Number	1653008215-01
Footprint	HD_2X1P_79_161X79_D
Description	PH 1x2P/2.0/NY6T/G-FL/VA/D/BK/H3.9/L2.8/W K
Setting	Function
NC	3.3V (Default)
(1-2)	3.8V for 5G module

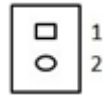

2.2.4.4 Power Saving Mode Settings for ERP1

ERP1 Power saving mode setting

Part Number	1653000014
Footprint	HD_2x2P_79
Description	PIN HEADER 2x2P 2.00mm 180D(M) SMD 21N22050
Setting	Function
(3-4)	Power saving mode
(1-2)	Normal operating (Default)



2.2.4.5 PCIe x16 Bifurcation Settings for J_CFG5

J_CFG5 PCIE X16 Bifurcation Setting	
Part Number	1653003101
Footprint	HD_3x1P_79_D
Description	PIN HEADER 3x1P 2.0mm 180D(M) DIP 2000-13 WS
Setting	Function
(1-2)	1 (Default)
(2-3)	0

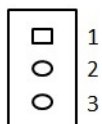

CFG[5]: PCI Express* Bifurcation

0 = 2 x8 PCI Express*

1 = 1 x16 PCI Express* (Default)

2.2.4.6 COM3 RI Power Settings J1 (AMO-I028) on AMO-I028 Card

J1 (AMO-I028) RI Power Settings	
Part Number	1653003201
Footprint	HD_3x2P_79_D
Description	PIN HEADER 3x2P 2.0mm 180D(M) DIP 21N22050
Setting	Function
(1-2)	Normal (default)
(3-4)	+5V
(5-6)	+12V

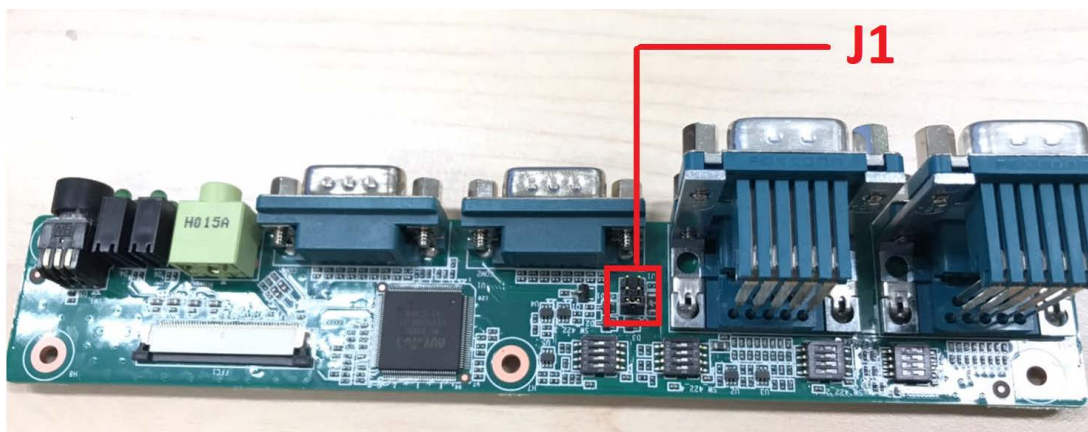
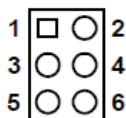

2.3 Connectors

2.3.1 ARK-3534 External I/O Locations

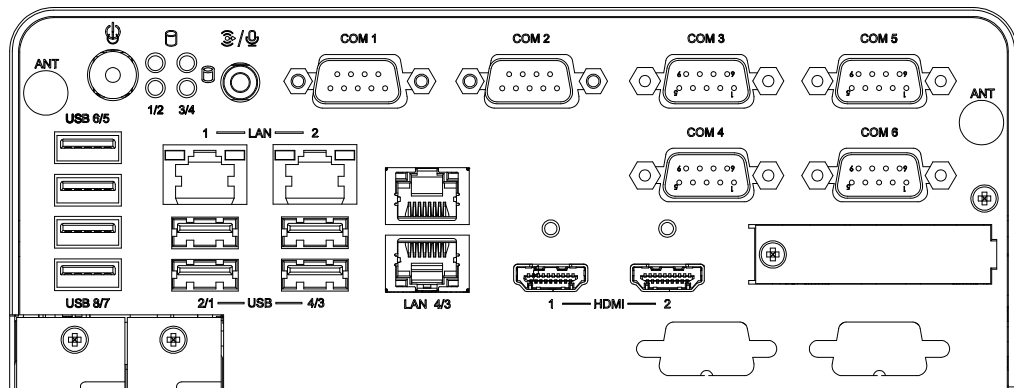

Figure 2.2 ARK-3534 Front and Rear I/O Connector Diagram

2.3.1.1 COM Connector

ARK-3534 provides up to 6 D-sub 9-pin connectors, which offers RS-232/422/485 serial communication interface ports. The default setting is RS-232, the mode RS-422/485 of ARK-3534 COM3/4/5/6 can be supported via the BIOS settings. COM1/2 supports RS-232.

■ COM3~COM6

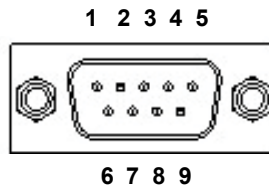

Figure 2.3 COM Connector

Table 2.2: COM Connector Pin Assignments

Pin	RS-232	RS-422	RS-485
	Signal Name	Signal Name	Signal Name
1	DCD	Tx-	DATA-
2	RxD	Tx+	DATA+
3	TxD	Rx+	NC
4	DTR	Rx-	NC
5	GND	GND	GND
6	DSR	NC	NC
7	RTS	NC	NC
8	CTS	NC	NC
9	RI	NC	NC

Note! NC represents “No Connection”.



■ COM1~COM2/COM7~COM8(Optional)

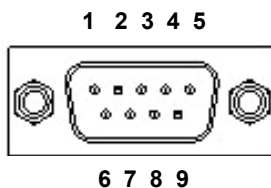

Table 2.3: COM Connector Pin Assignments

RS-232	
Pin	Signal Name
1	DCD
2	RxD
3	TxD
4	DTR
5	GND
6	DSR
7	RTS
8	CTS
9	RI

2.3.1.2 Ethernet Connector (LAN)

ARK-3534 is equipped with up to 4 x (LAN3/4 are optional by TPN support) Ethernet controllers that are fully compliant with IEEE 802.3u 10/100/1000 Mbps CSMA/CD standards. These Ethernet ports provide a standard RJ-45 jack connector with LED indicators on the front side that demonstrate its Active/Link status (Green LED) and Speed status (Green/Orange LED).

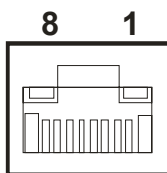

Figure 2.4 Ethernet Connector

Table 2.4: Ethernet Connector Pin Assignments

Pin	10/100/1000BaseT Signal Name
1	TX+
2	TX-
3	RX+
4	MDI2+
5	MDI2-
6	RX-
7	MDI3+
8	MDI3-

2.3.1.3 HDMI Connector

An integrated, 19-pin receptacle connector HDMI Type A Interface is provided. The HDMI link supports resolutions up to 4096 x 2160 @ 60 Hz.

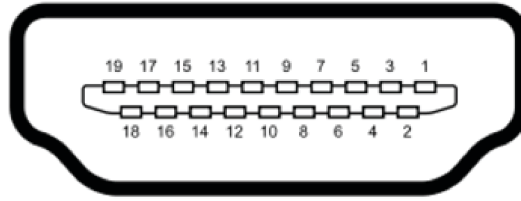

Figure 2.5 HDMI Receptacle Connector

Table 2.5: HDMI Connector Pin Assignments

Pin	Signal Name	Pin	Signal Name
1	TMDS Data 2+	2	TMDS Data 2 shield
3	TMDS Data 2-	4	TMDS Data 1+
5	TMDS Data 1 shield	6	TMDS Data 1-
7	TMDS Data 0+	8	TMDS Data 0 shield
9	TMDS Data 0-	10	TMDS clock+
11	TMDS clock shield	12	TMDS clock-
13	CEC	14	Reserved
15	SCL	16	SDA
17	DDC/CEC Ground	18	+5V
19	Hot Plug Detect		

2.3.1.4 DIO Connector (by Optional Cable)

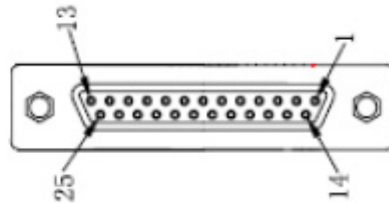

Figure 2.6 DIO Connector

Table 2.6: DIO Connector Pin Assignments

Pin	Signal Name	Pin	Signal Name
1	GND	14	GND
2	Port0 D0	15	Port1 D8
3	Port0 D1	16	Port1 D9
4	Port0 D2	17	Port1 D10
5	Port0 D3	18	Port1 D11
6	Port0 D4	19	Port1 D12
7	Port0 D5	20	Port1 D13
8	Port0 D6	21	Port1 D14
9	Port0 D7	22	Port1 D15
10	+5V	23	+5V
11	NC	24	NC

Table 2.6: DIO Connector Pin Assignments

12	NC	25	NC
13	NC		

Note! NC represents “No Connection”.



2.3.1.5 Power On/Off Button

ARK-3534 has a Power On/Off button with LED indicators on the front side that show “On” (Green LED) and “Off/Suspend” statuses (Orange LED). The power button supports dual functions: Soft Power - On/Off (Instant off or Delay 4 Seconds then off), and Suspend.



Figure 2.7 Power ON/OFF Button

2.3.1.6 Audio Connector

ARK-3534 features one phone jack connector that supports stereo Line-Out or Mic-In audio ports. The audio chip is controlled by ACL888S and compliant with the Azalea standards.

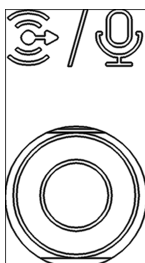

2.3.1.7 LED Indicators

There are four LEDs on the front panel that indicate the system’s status: The HDD LED is for HDD status.

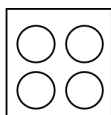

Figure 2.8 LED Indicators

2.3.1.8 USB 2.0

ARK-3534 (H610E) provides four USB 2.0 interface connectors. The USB interface supports plug-and-play functionality.

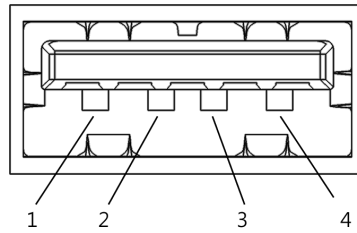

Table 2.7: USB 2.0 Pin Definitions

Pin	Signal Name
1	VCC
2	USB_data
3	USB_data+
4	GND

2.3.1.9 USB 3.2 - Gen2 and Gen1

ARK-3534 supports 4 x USB 3.2 (Gen2, 10G), 2 x USB 3.2 (Gen1, 5G), and 2 x Independent USB 3.2 (Gen1, 5G) interfaces. The USB interfaces comply with USB UHCI, Rev. 3.0 standards. Please refer to Table 2.5 for its pin assignments. USB 3.2 Gen1/2 connectors contain legacy pins to interface with USB 2.0 devices, and a new set of pins for USB 3.2 Gen1/2 connectivity.

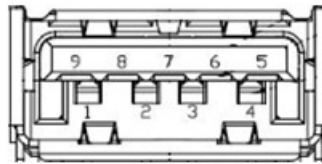

Figure 2.9 USB 3.2 Gen 1/2 Connector

Table 2.8: USB 3.2 Gen1/2 Connector Pin Assignments

Pin	Signal Name	Pin	Signal Name
1	+5V	2	USB_data-
3	USB_data+	4	GND
5	SSRX-	6	SSRX+
7	GND	8	SSTX-
9	SSTX+		

2.3.1.10 Remote Switch Connector

ARK-3534 provides the remote switch connector for power on/off with an external cable. From the left to the right are WDT, Power Switch, GND, and Reset.

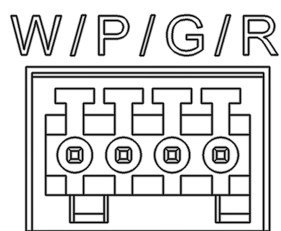

Figure 2.10 Remote Switch Connector

2.3.1.11 Phoenix Terminal Connector

ARK-3534 supports one 4-pin Phoenix terminal power input connector. Connect the positive and negative power cables to the terminals in the power distribution connector correctly at the same time.

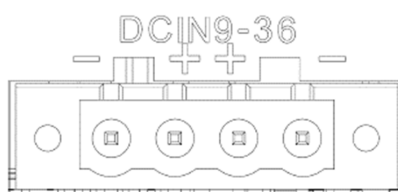

Figure 2.11 Phoenix Terminal Connector

Note!



1. For supply connections use wires suitable for at least 105°C.
2. The terminal block is suitable for 14 AWG. Torque value is 7lb-in. Use copper conductors only. It must be installed by a skilled person.
3. The terminal block uses two sets of interfaces to be installed at the same time to make it split to meet the maximum current limit, and a single pin will be limited below 16A.

Table 2.9: Phoenix Terminal Connector

Pin	Signal Name
-	GND
+	V-in

2.4 Installation

2.4.1 CPU/Memory Installation

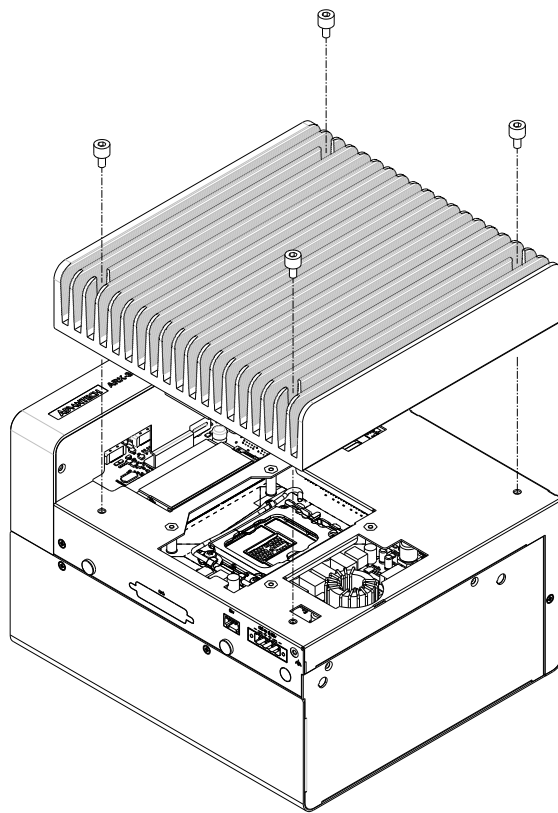

1. Unscrew the 4 screws on the top cover, and remove the top cover.

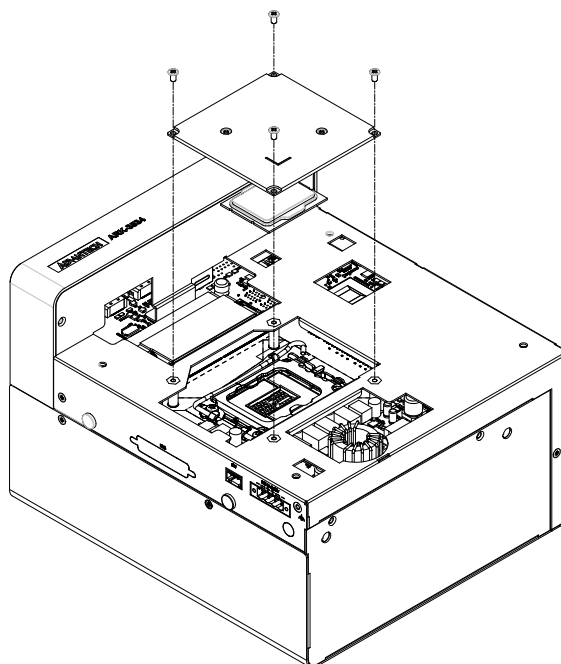

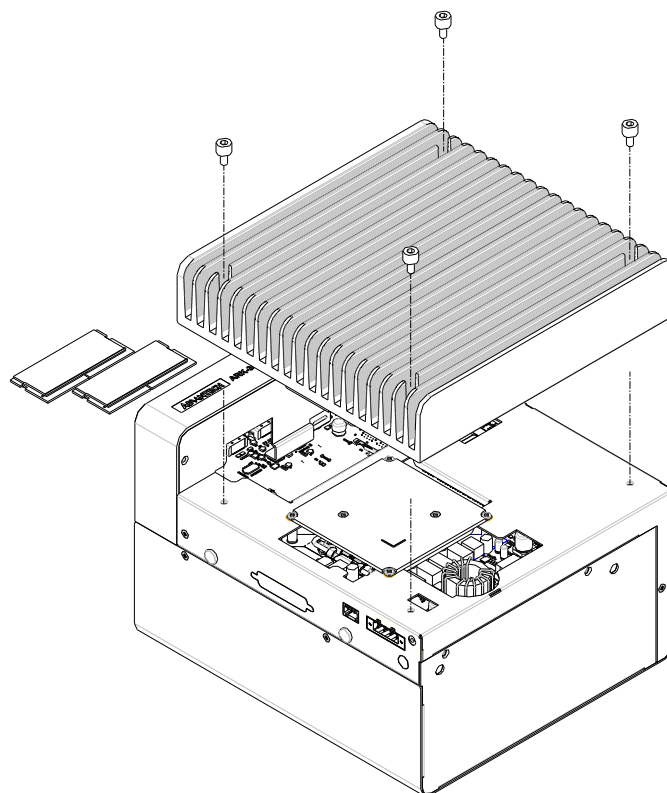

2. Install the CPU (LGA1151) and memory into the system.
3. Replace the top cover.

2.4.2 External HDD/SSD Installation

page 33

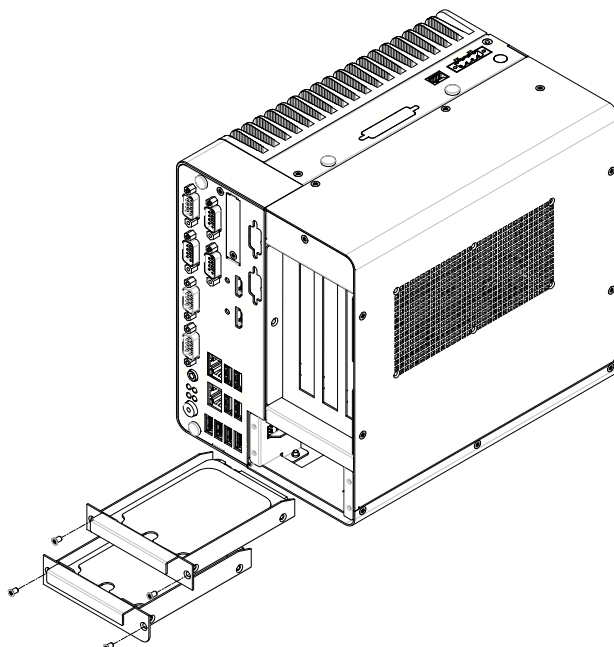

1. Unscrew the 2 x screws on the hard drive bay.
2. Install the HDD/SSD with 4 x screws on the HDD/SSD tray.
3. Push back the hard drive bay into the system and secure it using the same screws.

2.4.3 Mounting Kit Installation

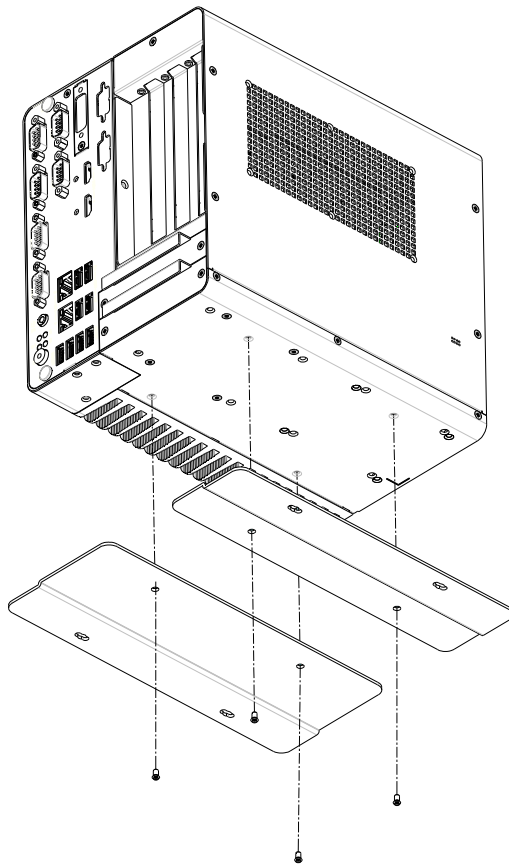

1. Take the mounting kit and 4 screws (M4x6L) out of the accessory box.
Sortez le kit de montage et les 4 vis (M4x6L) de la boîte d'accessoires.
2. Screw each of the 2 screws (M4x6L) on the left and right sides and fix the system horizontally on a table.
Vissez chacune 2 vis (M4x6L) sur les côtés gauche et droit et fixez le système horizontalement sur une table.

2.4.4 M.2 Module / Mini PCIe Module / Internal SIM Card Slot Installation

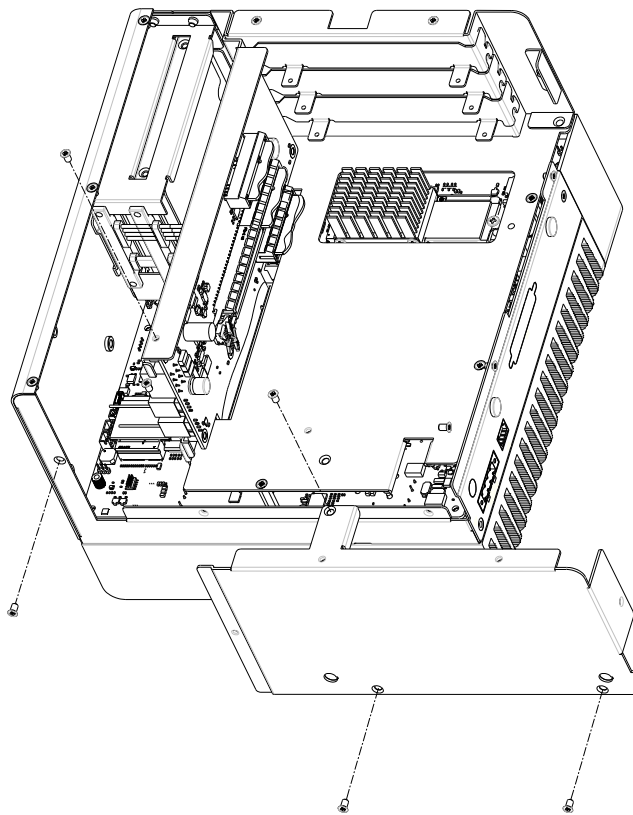
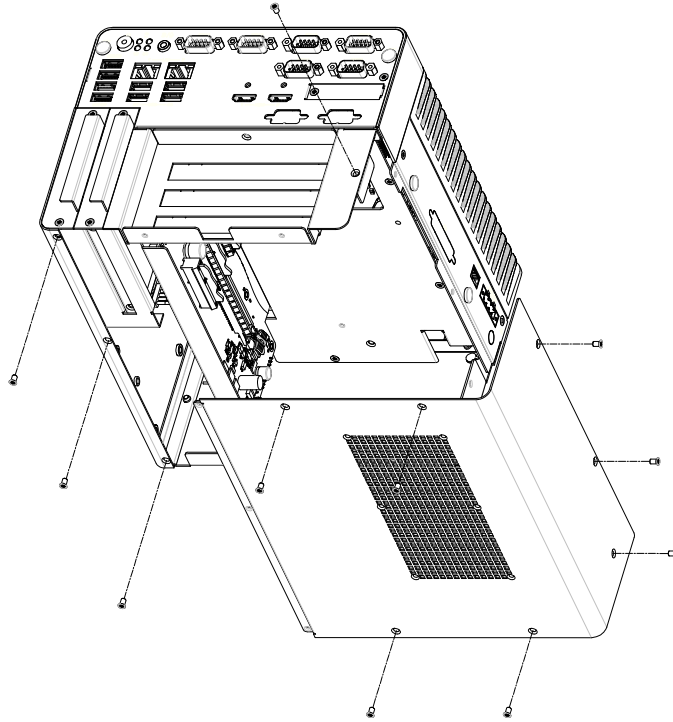

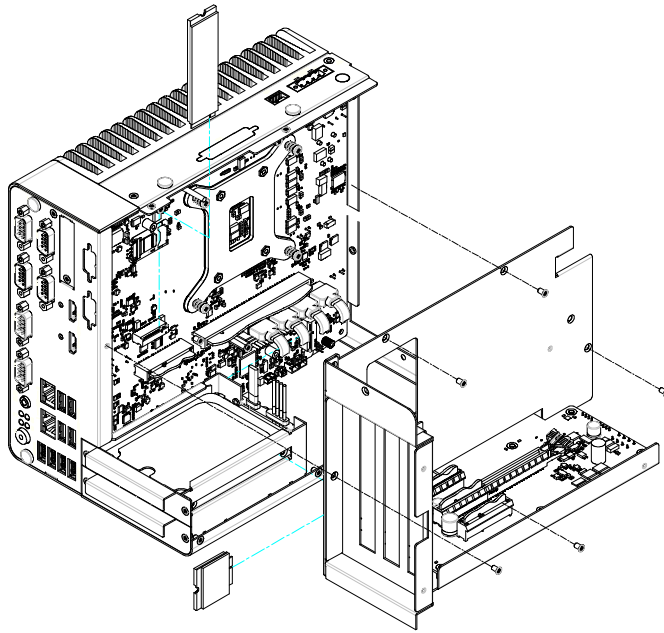

2.4.5 Attaching the Thermal pad

1. Take the thermal pad from the accessory box.
2. Paste the 30 x 30 x 0.2 mm thermal pad to the CPU (as illustrated above).
3. Paste the 46 x 46 x 1 mm piece to the copper block (as illustrated below).

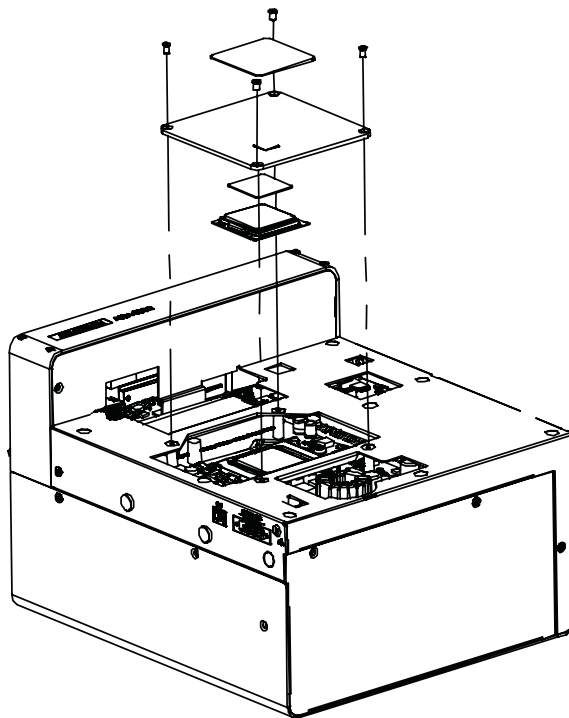

Chapter 3

BIOS Settings

3.1 Introduction

AMIBIOS has been integrated into motherboards for over two decades. With the AMIBIOS Setup program, users can modify BIOS settings and control various system features. This chapter describes the basic navigation of the ARK-3534 BIOS setup screens.

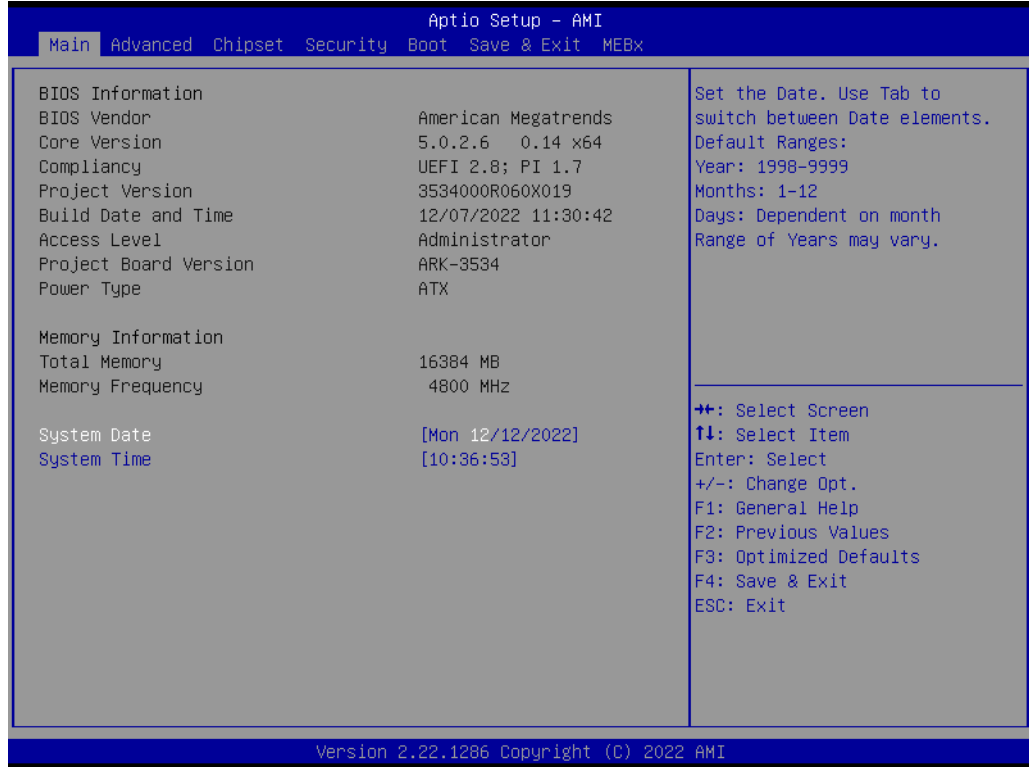

AMI's BIOS ROM has a built-in setup program that allows users to modify the basic system configuration. This information is stored in flash ROM so it retains the setup information when the power is turned off.

3.2 Entering the Setup

Turn on the computer and check for the patch code. If there is a number assigned to the patch code, it means that BIOS supports your CPU. If there is no number assigned to the patch code, please contact an Advantech application engineer to obtain an up-to-date patch code file. This will ensure that your CPU's system status is valid. After ensuring that you have a number assigned to the patch code, press and you will immediately be allowed to enter Setup.

3.2.1 Main Setup

When users first enter the BIOS Setup Utility, they will enter the Main setup screen. Users can always return to the Main setup screen by selecting the Main tab. There are two Main Setup options. They are described in this section. The Main BIOS Setup screen is shown below.



The Main BIOS setup screen has two main frames. The left frame displays all the options that can be configured. Grayed-out options cannot be configured; options in blue can. The right frame displays the key legend.

Above the key legend is an area reserved for a text message. When an option is selected in the left frame, it is highlighted in white. Often a text message will accompany it.

System Time / System Date

Use this option to change the system time and date. Highlight System Time or System Date using the <Arrow> keys. Enter new values through the keyboard. Press the <Tab> key or the <Arrow> keys to move between fields. The date must be entered in MM/DD/YY format. The time must be entered in HH:MM:SS format.

3.2.2 Advanced BIOS Features Setup

Select the Advanced tab from the ARK-3534 setup screen to enter the Advanced BIOS Setup screen. Users can select any item in the left frame of the screen, such as CPU Configuration, to go to the sub-menu for that item. Users can display an Advanced BIOS Setup option by highlighting it using the <Arrow> keys. All Advanced BIOS Setup options are described in this section. The Advanced BIOS Setup screens are shown below. The sub-menus are described on the following pages.

3.2.2.1 CPU Configuration

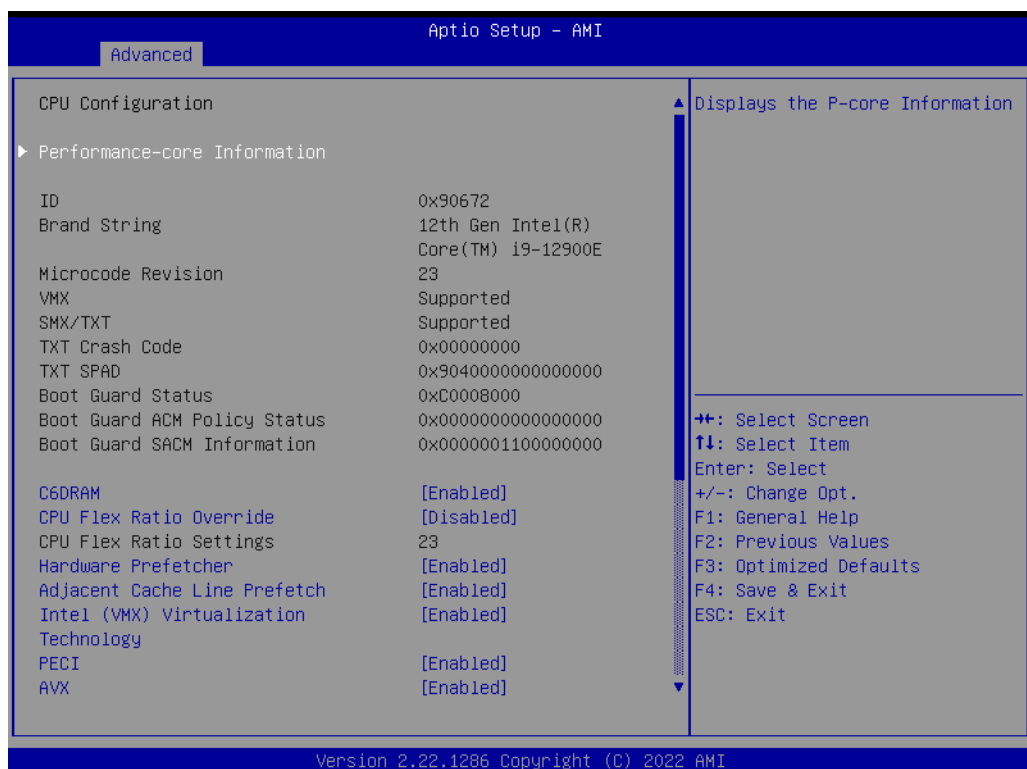
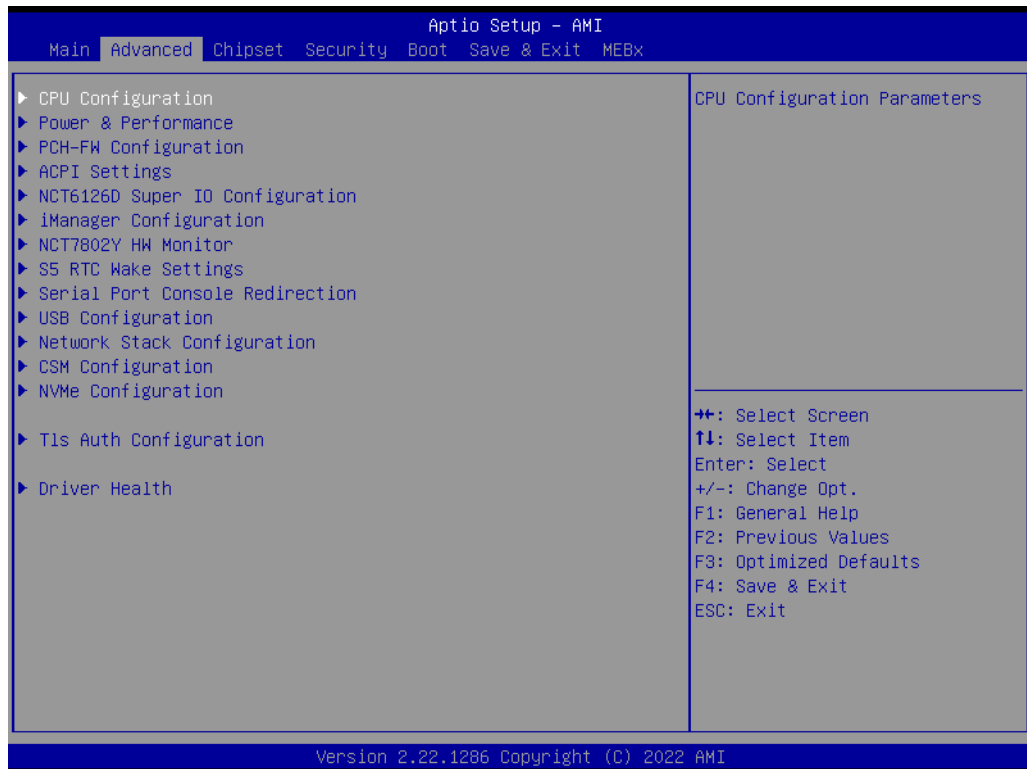

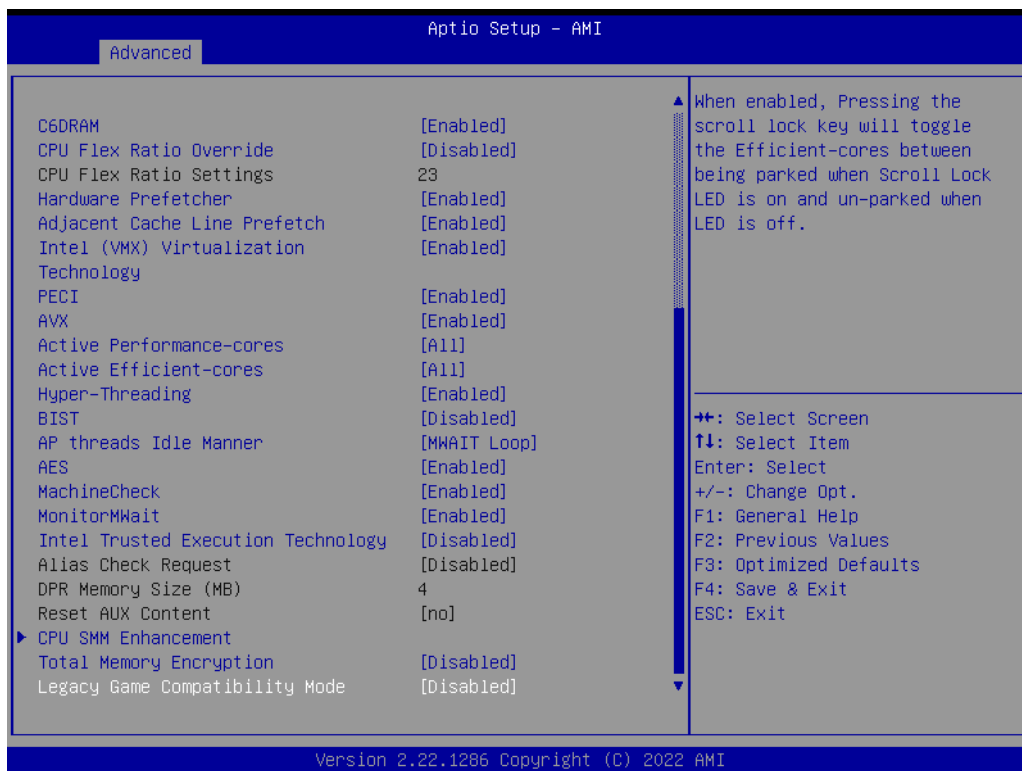

- **Performance-core Information**
Displays the P-core Information
- **C6DRAM**
Enable/Disable moving of DRAM contents to PRM memory when CPU is in C6 state.
- **CPU Flex Ratio Override**
Enable/Disable CPU Flex Ratio Programming.
- **CPU Flex Ratio Settings**
This value must be between Max Efficiency Ratio (LFM) and Maximum non-turbo ratio set by Hardware (HFM).
- **Hardware Prefetcher**
To turn on/off the MLC streamer prefetcher.
- **Adjacent Cache Line Prefetch**
To turn on/off prefetching of adjacent cache lines.
- **Intel (VMX) Virtualization Technology**
When enabled, a VMM can utilize the additional hardware capabilities provided by Vanderpool Technology.
- **PECI**
Enable/Disable Peci.
- **AVX**
Enable/Disable the Avx 2 Instructions. This is applicable for Performance-core only
- **Active Performance-Cores**
Number of cores to enable in each processor package.
- **Active Efficient-cores**
Enable/Disable Per Core Disable. When Per Core Disable Configuration is enabled, selection of Active Cores and Active Efficient-cores will be disabled.

-
- **Hyper-Threading**
Enable or Disable Hyper-Threading Technology.
 - **BIST**
Enable/Disable BIST (Built-in Self Test) on reset
 - **AP threads Idle Manner**
AP threads Idle Manner for waiting signal to run.
 - **AP threads Idle Manner**
AP threads Idle Manner for waiting signal to run.
 - **AES**
Enable/Disable AES (Advanced Encryption Standard)
 - **MachineCheck**
Enable/Disable Machine Check.
 - **MonitorMWait**
Enable/Disable MonitorMWait, if Disable MonitorMwait, the AP threads Idle Manner should not set in MWAIT Loop
 - **Intel Trusted Execution Technology**
Enables utilization of additional hardware capabilities provided by Intel® Trusted Execution Technology.
 - **Alias Check Request**
Enables Txt Alias Checking capability.
 - **DPR memory size (MB)**
Reserve DPR memory size (0-255) MB
 - **Reset AUX Content**
Reset TPM Aux content. Txt may not functional after AUX content gets reset.
 - **Total Memory Encryption**
Configure Total Memory Encryption (TME) to protect DRAM data from physical attacks.
 - **Legacy Game Compatibility Mode**
When enabled, Pressing the scroll lock key will toggle the Efficient-cores between being parked when Scroll Lock LED is on and un-parked when LED is off.

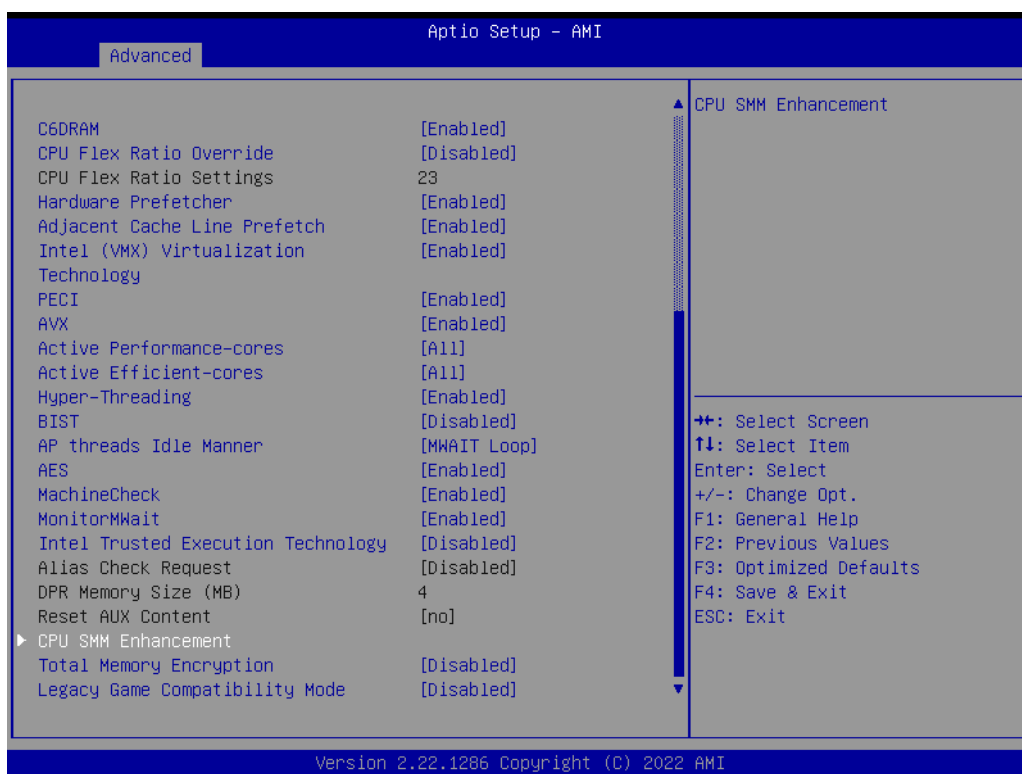

- SMM Use Delay Indication
Enable/Disable usage of SMM_DELAYED MSR for MP sync in SMI.
- SMM Use Block Indication
Enable/Disable usage of SMM_BLOCKED MSR for MP sync in SMI.
- SMM Use en-US Indication
Enable/Disable usage of SMM_ENABLE MSR for MP sync in SMI

3.2.2.2 Power and Performance – CPU Power Management Control

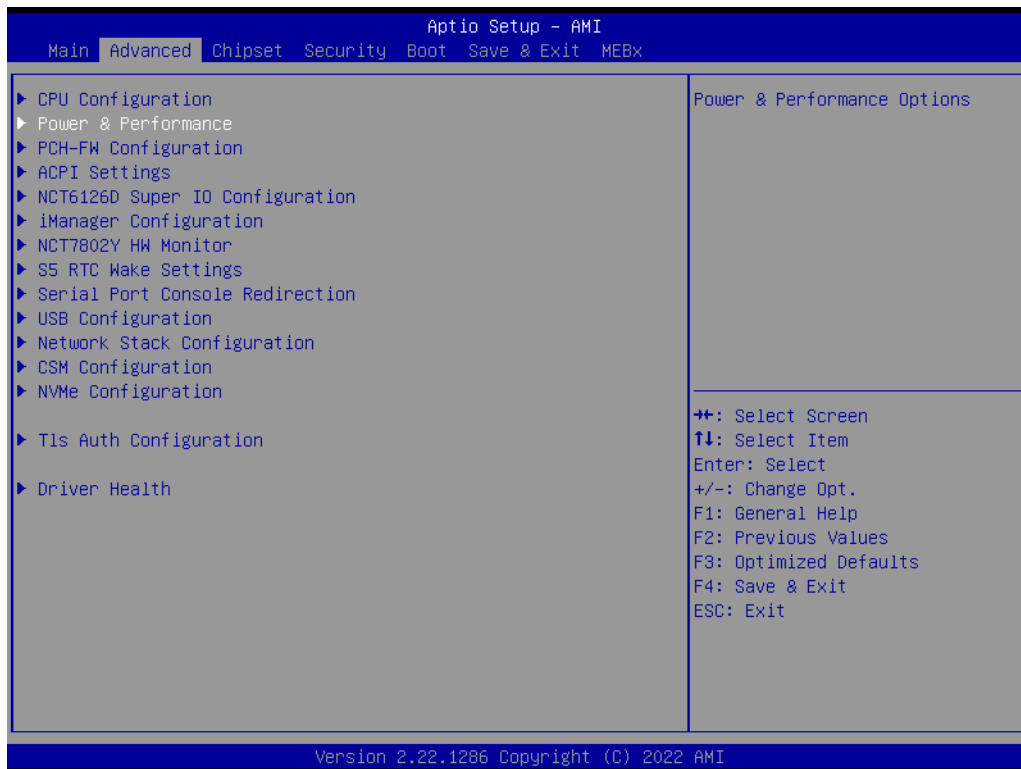

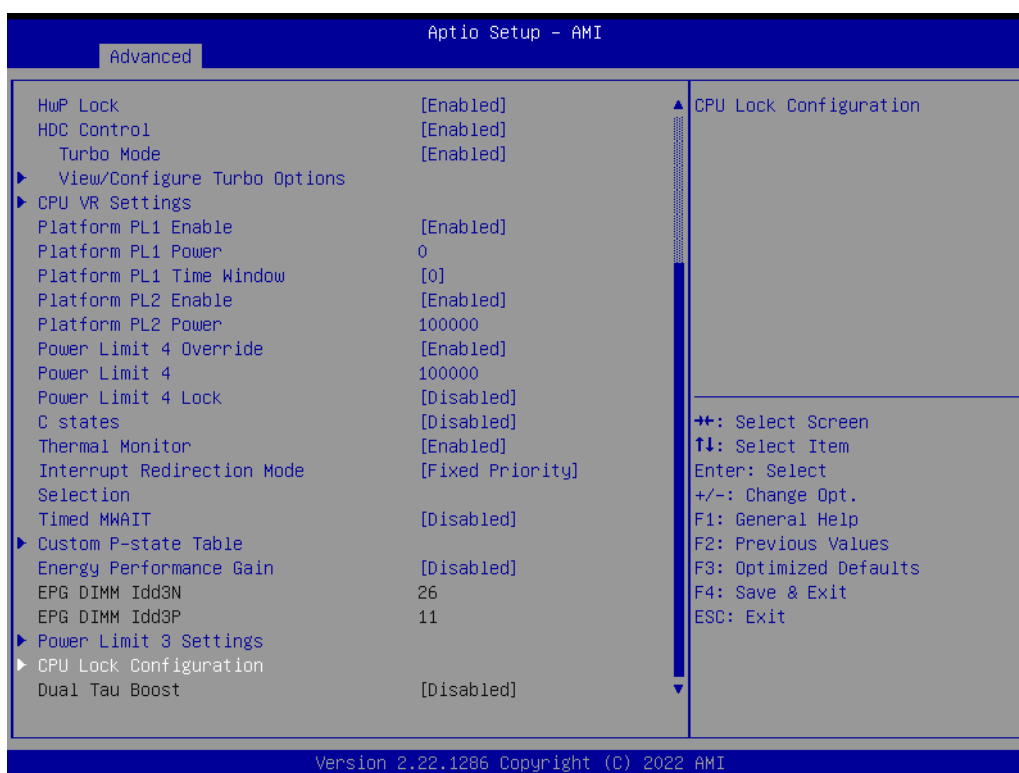
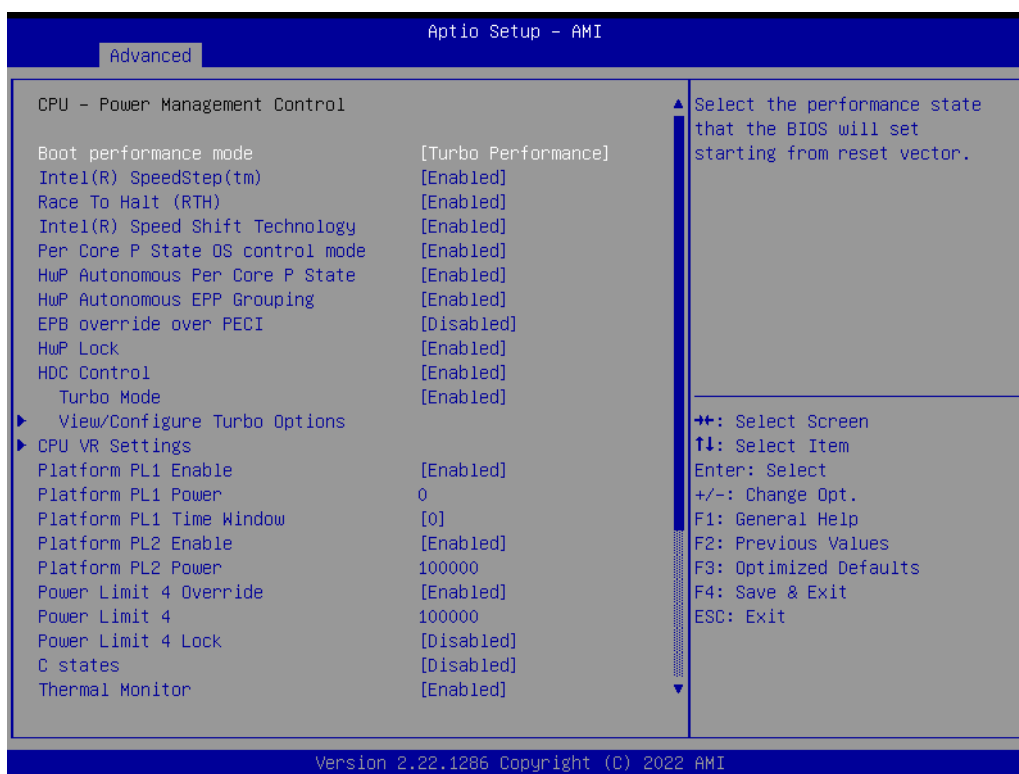

- **Boot Performance**
Select the performance state that the BIOS will set before OS hand-off.
- **Intel® Speedstep™**
Allows more than two frequency ranges to be supported.

- **Race to Halt (RTH)**
Enable/Disable the Race To Halt feature. RTH will dynamically increase CPU frequency in order to enter pkg C-State faster to reduce overall power. (RTH is controlled through MSR 1FC bit 20).
- **Intel® Speed Shift Technology**
Enable/Disable Intel® Speed Shift Technology support. Enabling will expose the CPPC v2 interface to allow for hardware controlled P-states.
- **Per core P state OS control mode**
Enable/Disable Per Core P state OS control mode. Disabling will set Bit 31 = 1 command 0x06. When set, the highest core request is used for all other core requests.
- **Hwp Autonomous Per core P state**
Disable Autonomous PCPS (Bit 30 = 1, command 0x11) Autonomous will request the same value for all cores all the time. Enable PCPS (default Bit 30 = 0, command 0x11).
- **Hwp Autonomous EPP grouping**
Enable EPP grouping (default Bit 29 =0, command 0x11) Autonomous will request the same values for all cores with same EPP. Disable EPP grouping (Bit 29 =1, command 0x11) autonomous will not necessarily request same values for all cores with same EPP.
- **EPB override over PECl**
Enable/Disable EPB override over PECl. Enable by sending pcode command 0x2b, subcommand 0x3 to 1. This will allow OOB EPB PECl override control
- **HWP Lock**
Enable/Disable HWP Lock support in Misc Power Management MSR.
- **HDC Control**
This option allows HDC configuration.
- **Turbo Mode**
Enable/Disable processor Turbo Mode (requires Intel Speed Step or Intel Speed Shift to be available and enabled).
- **Platform PL1 Enable**
Enable/Disable Platform Power Limit 1 programming.
- **Platform PL1 Power**
Platform Power Limit 1 Power in milliwatts.
- **Platform PL1 Time Window**
Platform Power Limit 1 Time Window value in seconds.
- **Platform PL2 Enable**
Enable/Disable Platform Power Limit 2 programming.
- **Platform PL2 Power**
Platform Power Limit 2 Power in Milli Watts.
- **Power Limit 4 Override**
Enable/Disable Power Limit 4 override.
- **Power Limit 4**
Power Limit 4 in milliwatts.
- **Power Limit 4 Lock**
Power Limit 4 MSR 601h Lock. When enabled PL4 configurations are locked during OS. When disabled PL4 configuration can be changed during OS.
- **C states**
Enable/Disable CPU Power Management.

- **Thermal Monitor**
Enable/Disable Thermal Monitor
- **Interrupt Redirection Mode Selection**
Interrupt Redirection Mode Select for Logical Interrupts
- **Timed MWAIT**
Enable/Disable Timed MWAIT Support
- **Energy Performance Gain**
Enable/disable Energy Performance Gain.

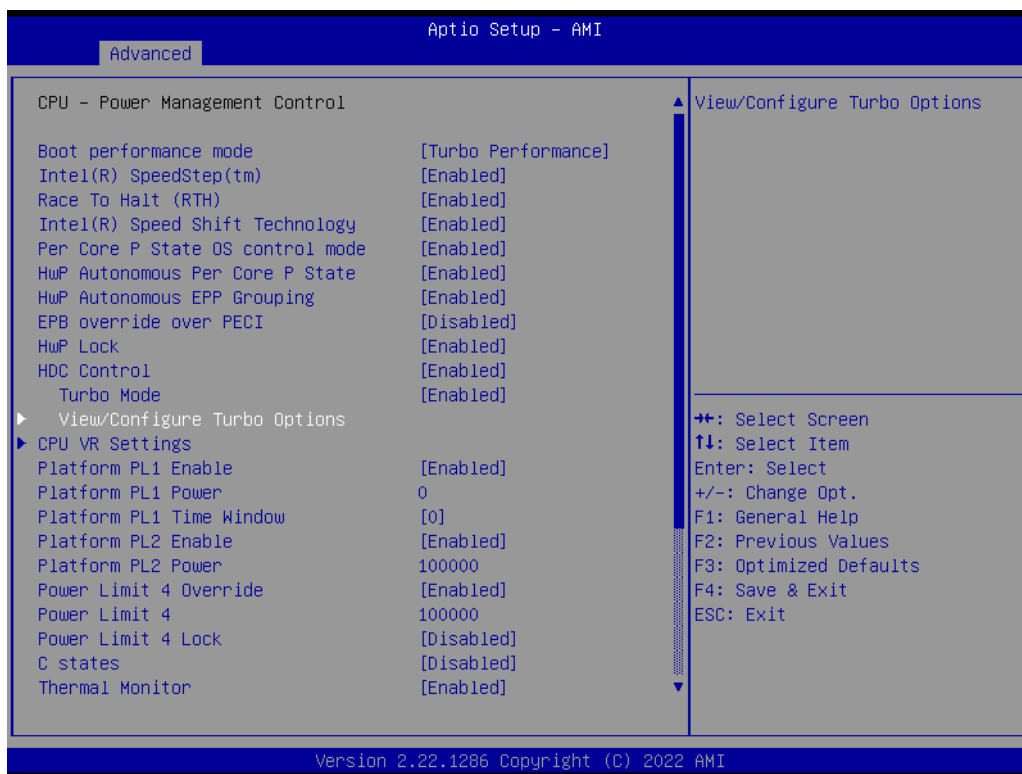

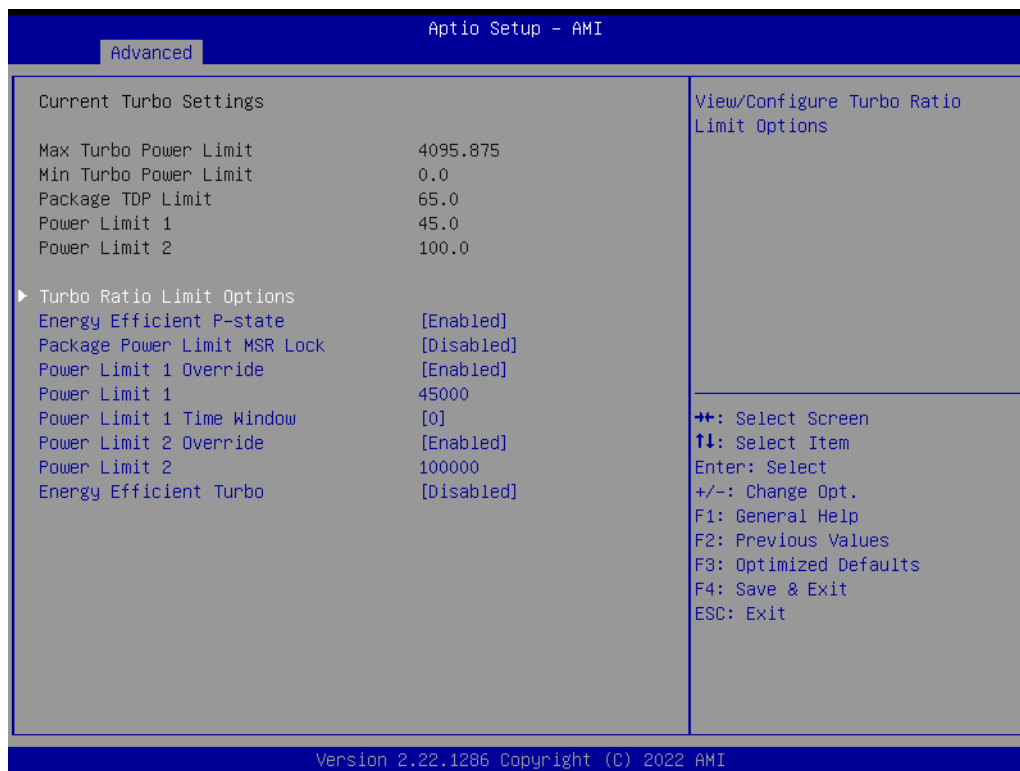

- Energy Efficient P-state
Enable/Disable Energy Efficient P-state feature.
- Package Power Limit MSR Lock
Enable/Disable locking of Package Power Limit settings.
- Power Limit 1 Override
Enable/Disable Power Limit 1 override.
- Power Limit 1
Power Limit 1 in milliwatts.
- Power Limit 1 Time Window
Power Limit 1 Time Window value in seconds.
- Power Limit 2 Override
Enable/Disable Power Limit 2 override.
- Power Limit 2
Power Limit 2 value in milliwatts.
- Energy Efficient Turbo
Enable/Disable the Energy Efficient Turbo feature. This feature will opportunistically lower the turbo frequency to increase efficiency.

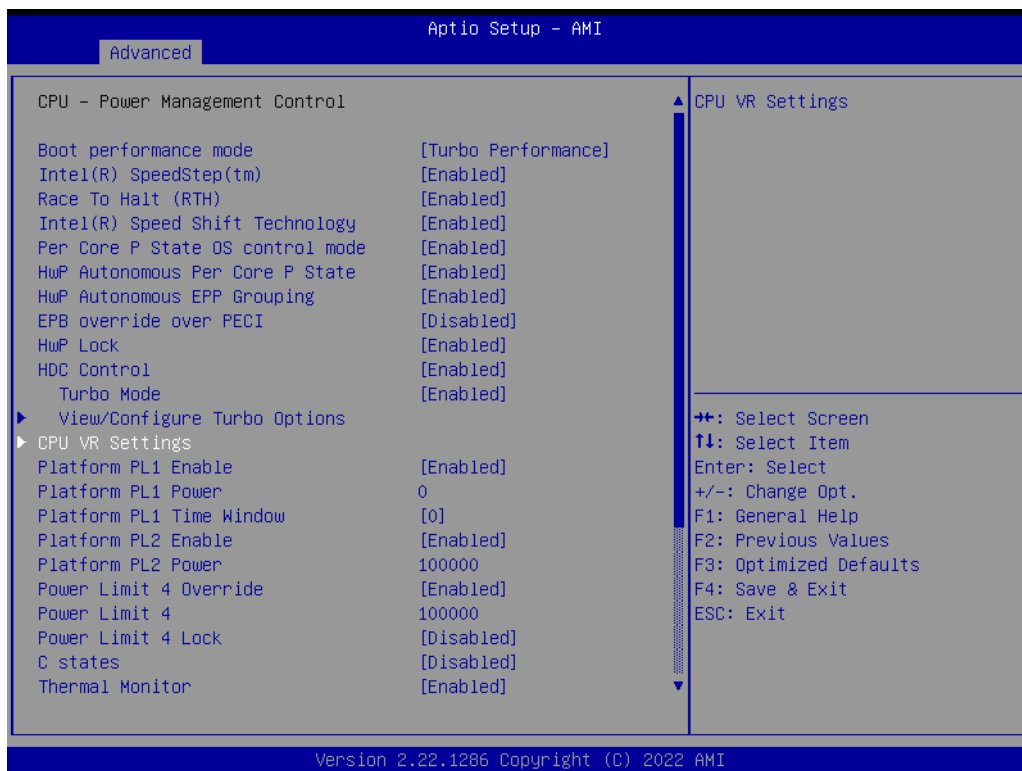

- PSYS Slope
PSYS Slope defined in 1/100 increments. The range is 0-200. For a 1.25 slope, enter 125. 0 = AUTO. Uses BIOS VR mailbox command 0x9.
- PSYS Offset
PSYS Offset defined in 1/1000 increments. The range is 0-63999. For an offset of 25.348, enter 25348. PSYS Uses BIOS VR mailbox command 0x4.

-
- PSYS prefix
Sets the offset value as positive or negative.
 - PSYS PMax Power
PSYS PMax power, defined in 1/8-Watt increments. Range 0-8191. For a PMax of 125W, enter 1000. 0 = AUTO. Uses BIOS VR mailbox command 0xB.
 - Min Voltage Override
Min Voltage Override. Enable to override minimum voltage for runtime and for C8.
 - Vccln Aux Icc Max
Sets the Max Icc Vccln Aux value defined in 1/4A increments. Range is 0-512. For an IccMax 32A, enter 128(32*4).
 - Vccln Aux IMON Slope
Vccln Aux IMON Slope defined in 1/100 increments. Range is 0-200. For a 1.25 slope, enter 125. 0 = AUTO. Uses BIOS VR mailbox command 0x18.
 - Vccln Aux IMON Offset
Vccln Aux IMON Offset defined in 1/1000 increments. Range is 0-63999. For an offset of 25.348, enter 25348. IMON Uses BIOS VR mailbox command 0x18.
 - Vccln Aux IMON Prefix
Sets the offset value as positive or negative.
 - Vsys Critical
Vsys Critical Enable or disable.
 - VR Power Delivery Design
Specifies the ADL Desktop board design used for the VR settings override values. By default, BIOS will override the default Desktop VR settings based on the board design. A value of AUTO(0) will use the board ID to determine the board design. Any other value will override the board ID logic to provide a custom VR Power Delivery Design value. This is intended primarily for validation.

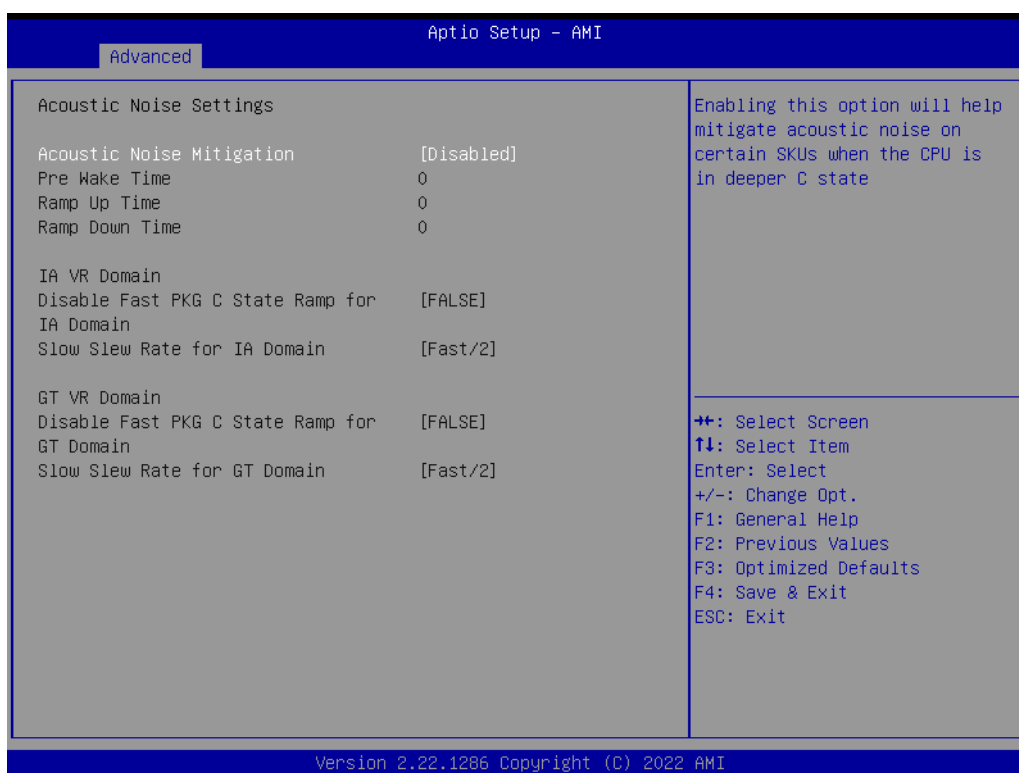

- Acoustic Noise Mitigation
Enabling this option will help mitigate acoustic noise on certain SKUs when the CPU is in a deeper C state.
- Pre Wake time
Set the maximum Pre Wake randomization time in micro ticks. Range is 0-255. This is for acoustic noise mitigation Dynamic Periodicity Alteration (DPA) tuning.

- Ramp Up Time
Set the maximum Ramp Up randomization time in micro ticks. The range is 0-255. This is for acoustic noise mitigation Dynamic Periodicity Alteration (DPA) tuning.
- Ramp Down Time
Set the maximum Ramp Down randomization time in micro ticks. Range is 0-255. This is for acoustic noise mitigation Dynamic Periodicity Alteration (DPA) tuning.
- Disable Fast PKG C State Ramp for IA Domain
This option needs to be configured to reduce acoustic noise during deeper C states. False: Don't disable Fast ramp during deeper C states; True: Disable Fast ramp during deeper C states.
- Slow Slew Rate for IA Domain
Set VR IA Slow Slew Rate for Deep Package C State ramp time; Slow slew rate equals to Fast divided by number, the number is 2, 4, 8, 16 to slow down the slew rate to help minimize acoustic noise
- Disable Fast PKG C State Ramp for GT Domain
This option needs to be configured to reduce acoustic noise during deeper C states. False: Don't disable Fast ramp during deeper C states; True: Disable Fast ramp during deeper C states.
- Slow Slew Rate for GT Domain
Set VR GT Slow Slew Rate for Deep Package C State ramp time; Slow slew rate equals to Fast divided by number, the number is 2, 4, 8 to slow down the slew rate to help minimize acoustic noise; divide by 16 is disabled.

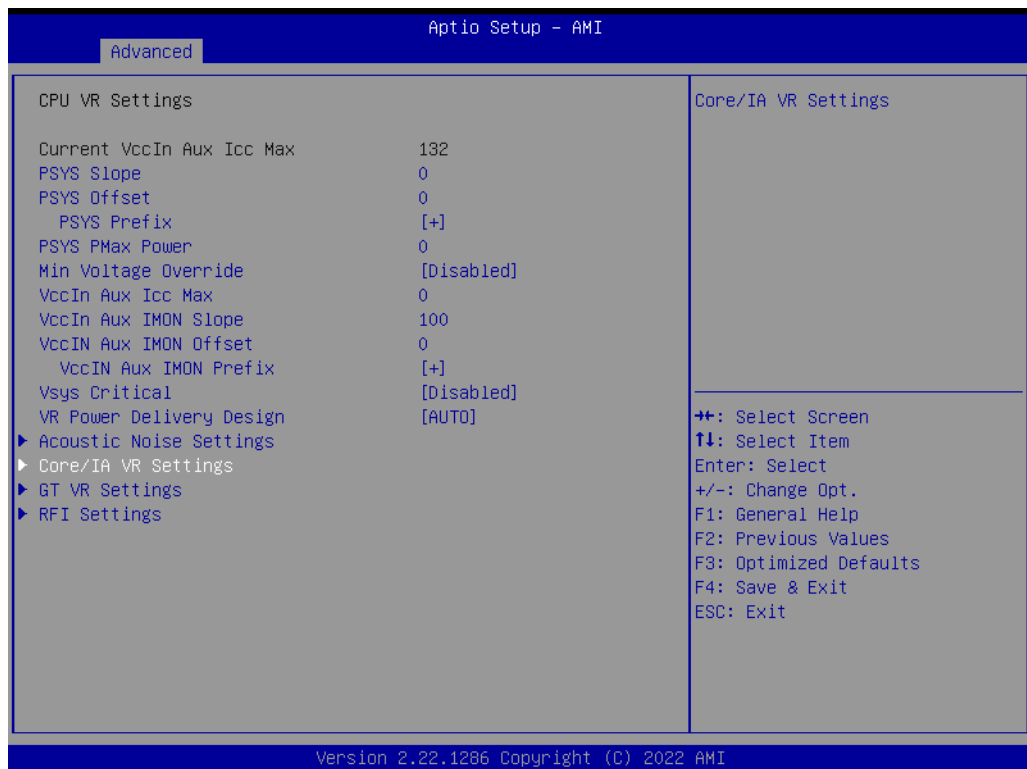

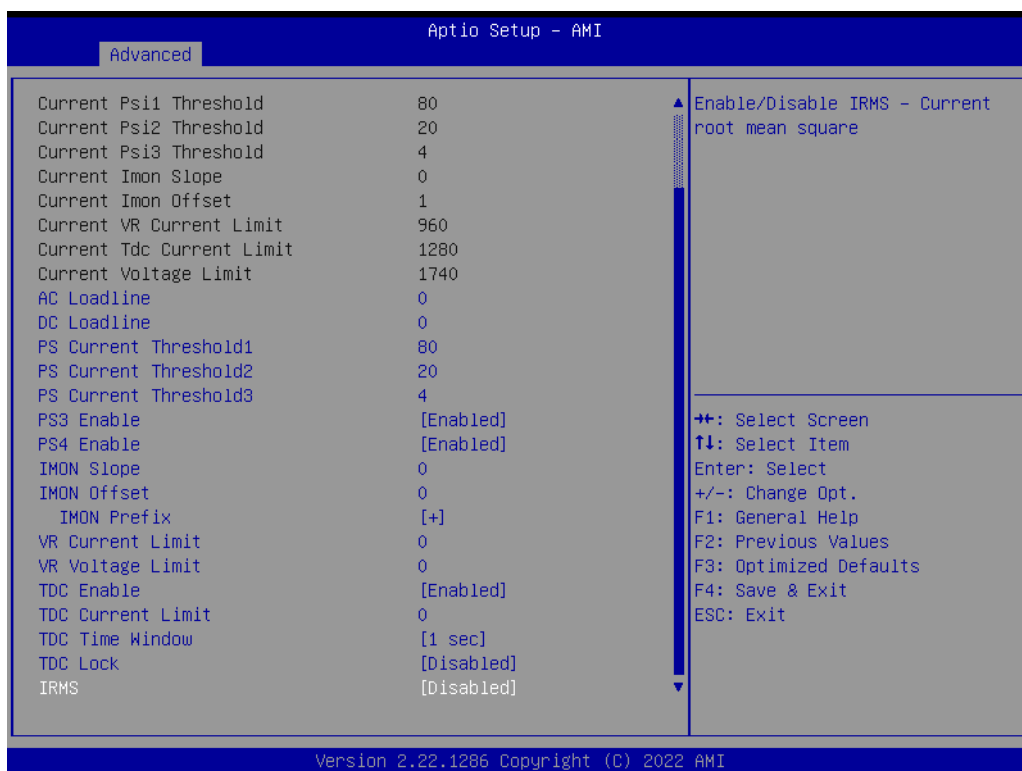
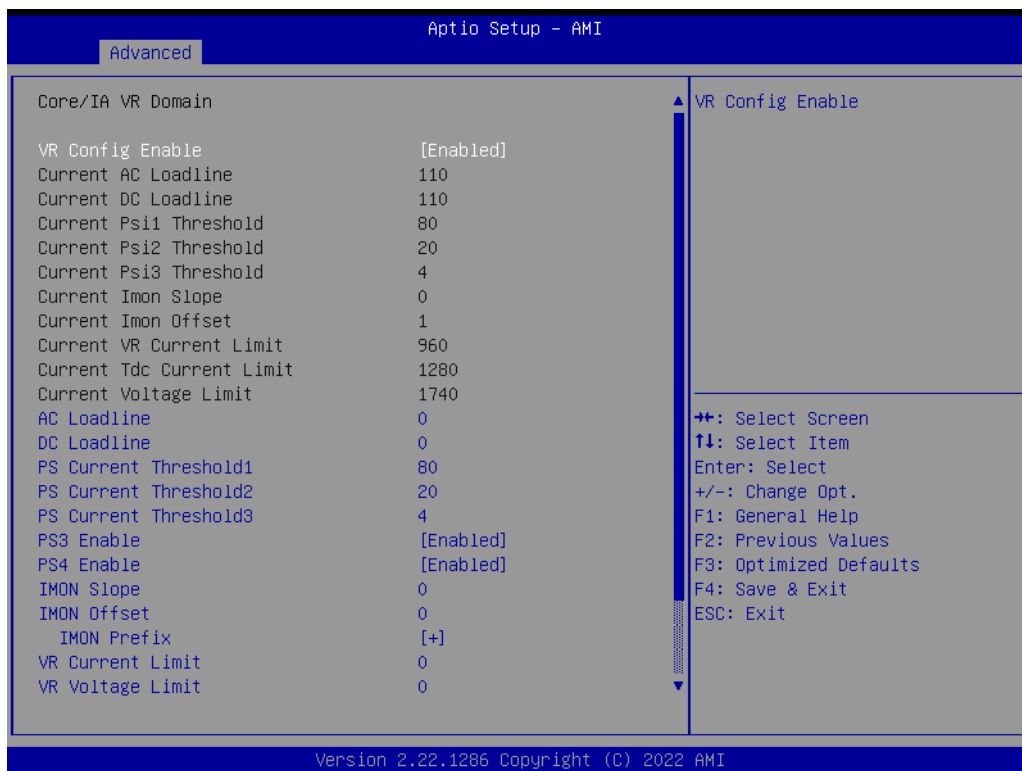

- VR Config Enable
VR Config Enable
- PS3 Enable
PS3 Enable/Disable. 0 - Disabled, 1 - Enabled. Uses BIOS VR mailbox command 0x3.

- PS4 Enable
PS4 Enable/Disable. 0 - Disabled, 1 - Enabled. Uses BIOS VR mailbox command 0x3.
- IMON Prefix
Sets the offset value as positive or negative.

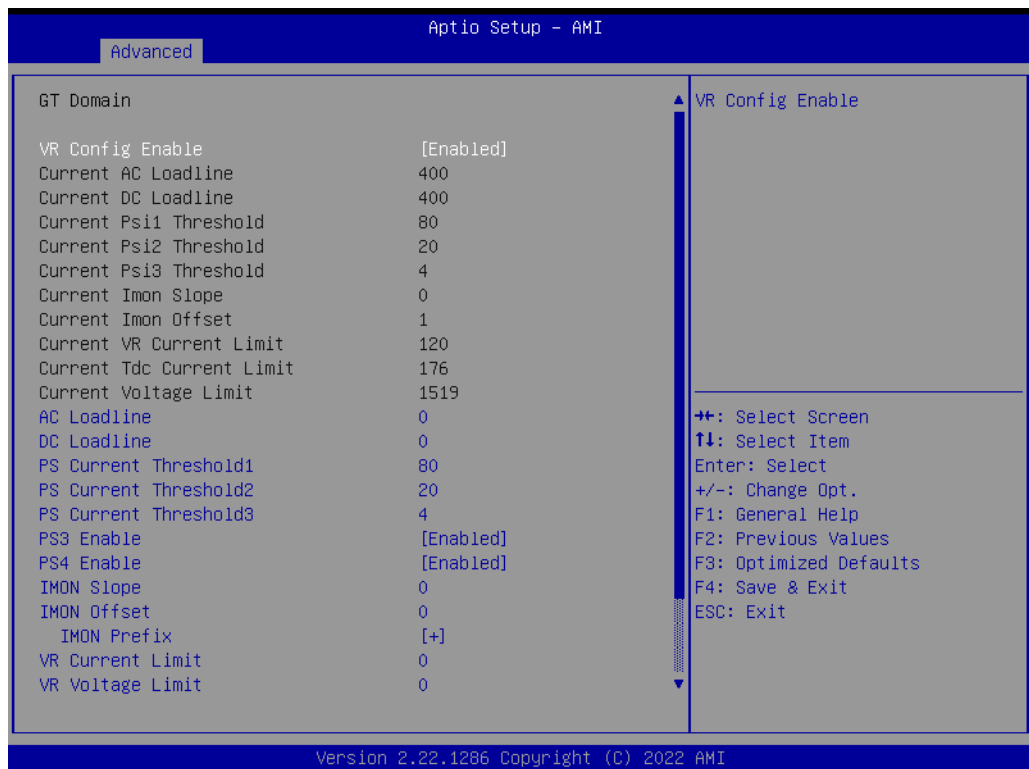
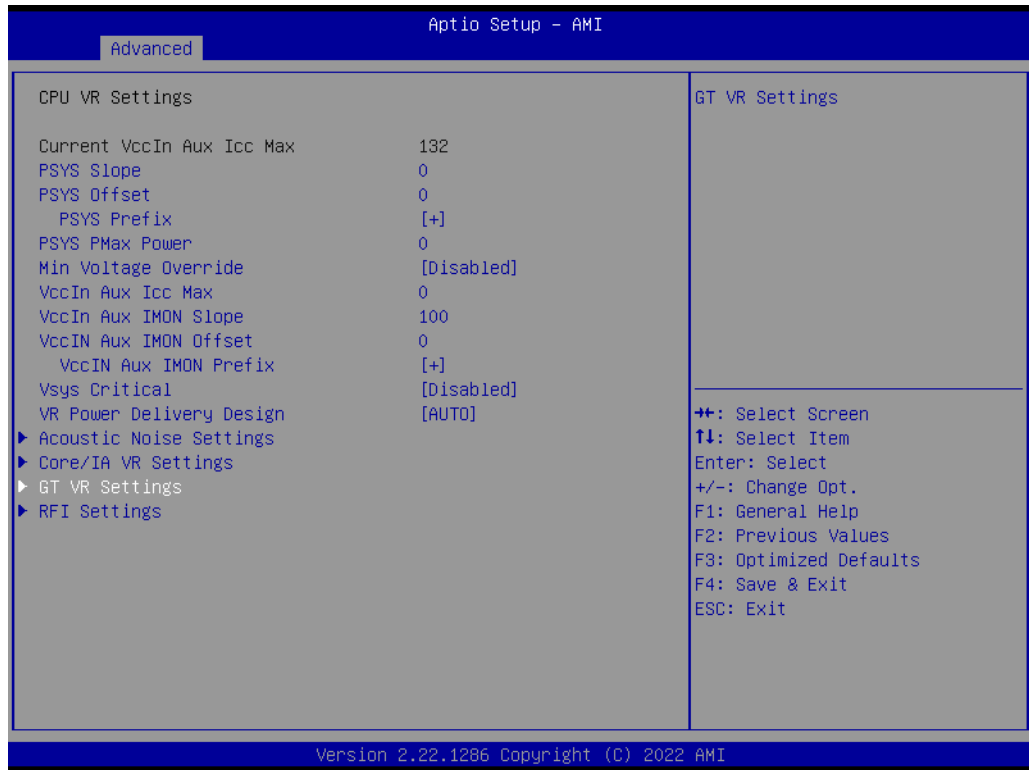

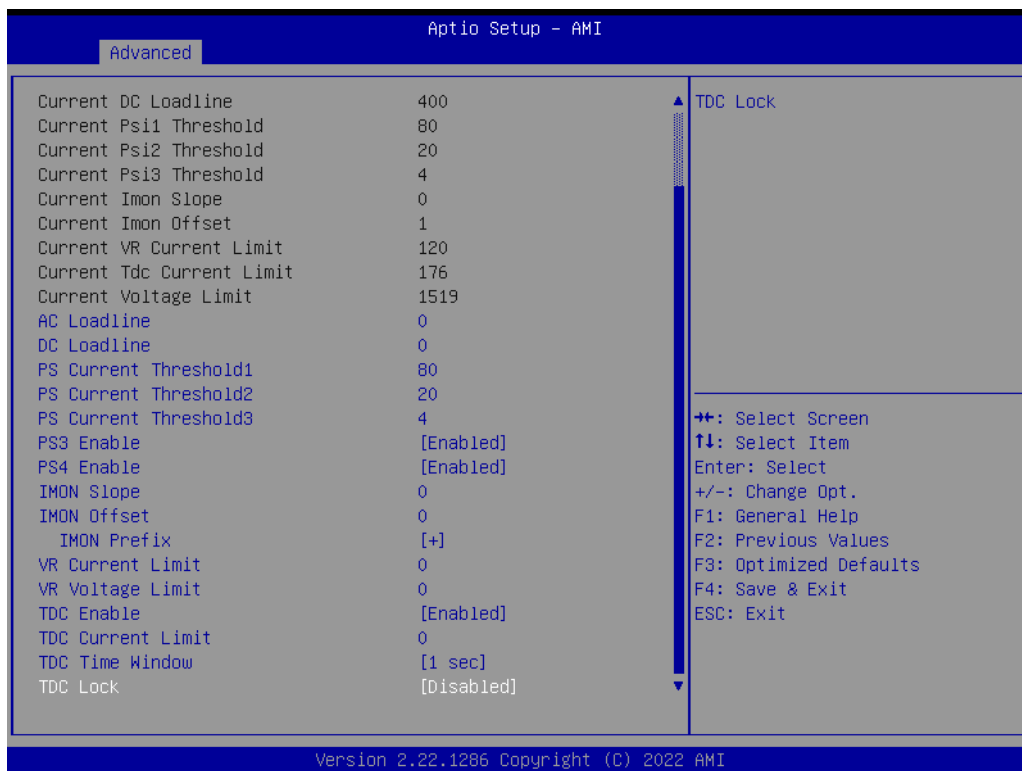

- VR Config Enable
VR Config Enable
- PS3 Enable
PS3 Enable/Disable. 0 - Disabled, 1 - Enabled. Uses BIOS VR mailbox command 0x3.
- PS4 Enable
PS4 Enable/Disable. 0 - Disabled, 1 - Enabled. Uses BIOS VR mailbox command 0x3.

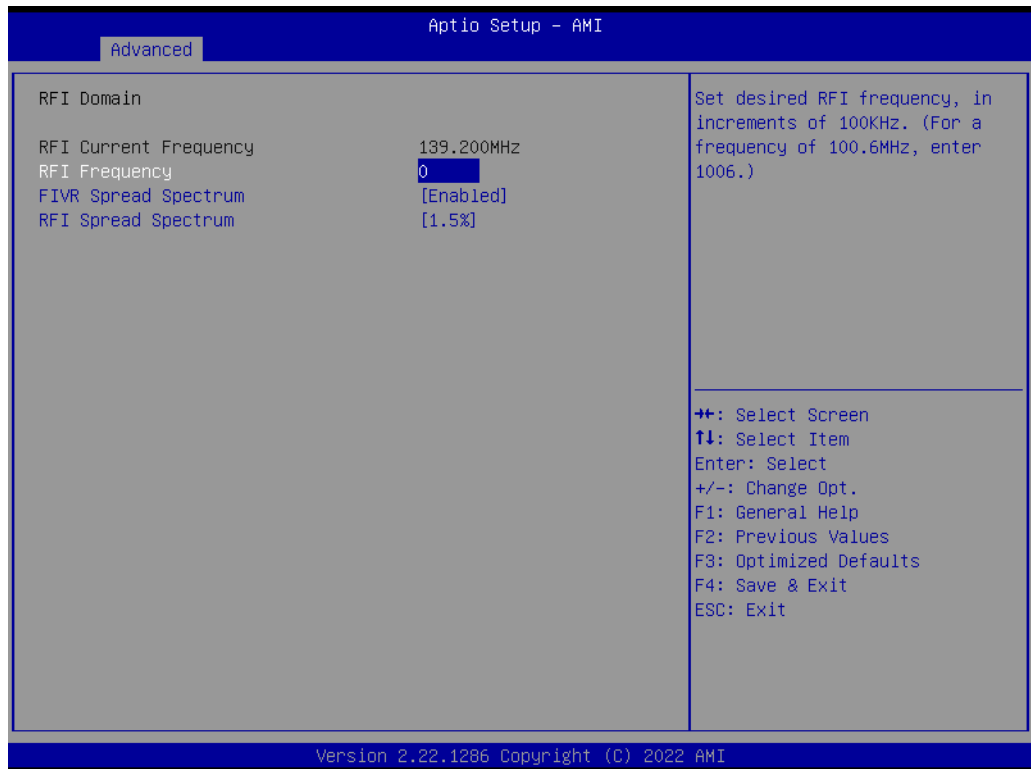
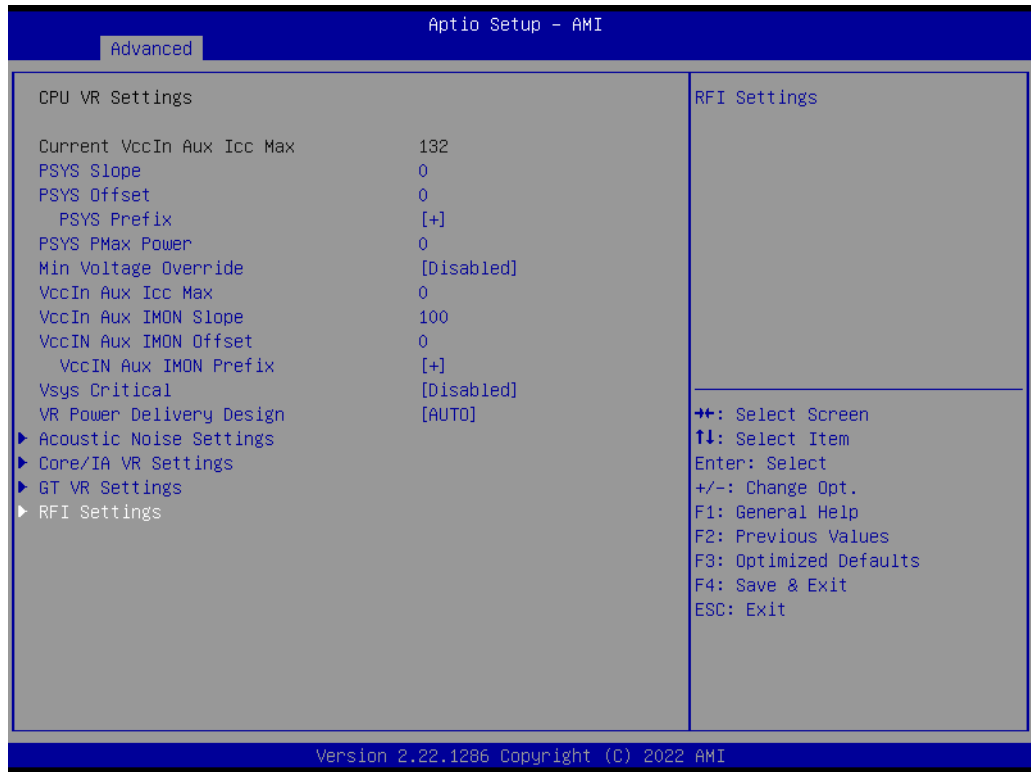

- FIVR Spread Spectrum
Enable or Disable the FIVR Spread Spectrum.
- RFI Spread Spectrum
Set the Spread Spectrum.

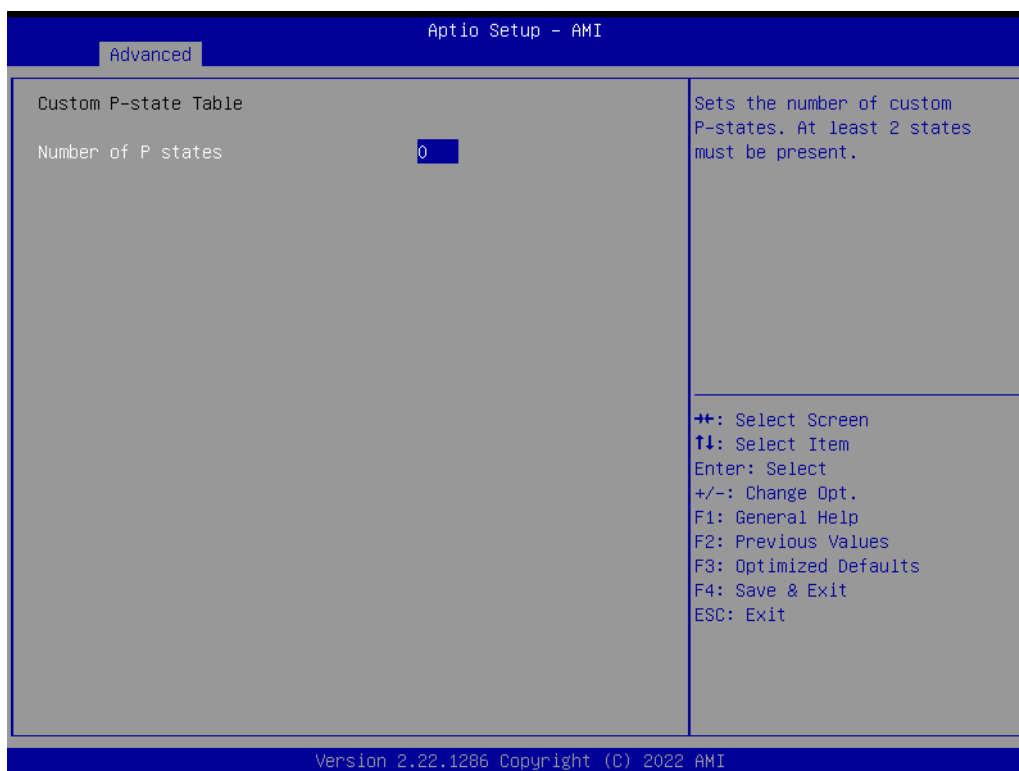
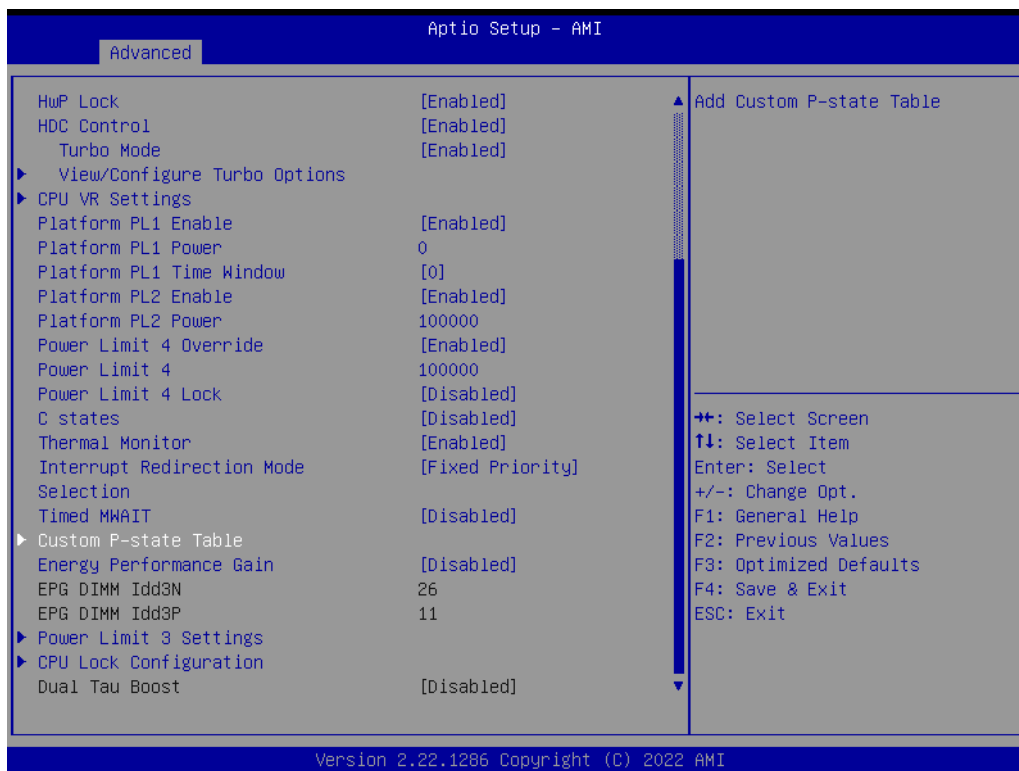

- Number of P states
Sets the number of custom P-states. At least 2 states must be present.

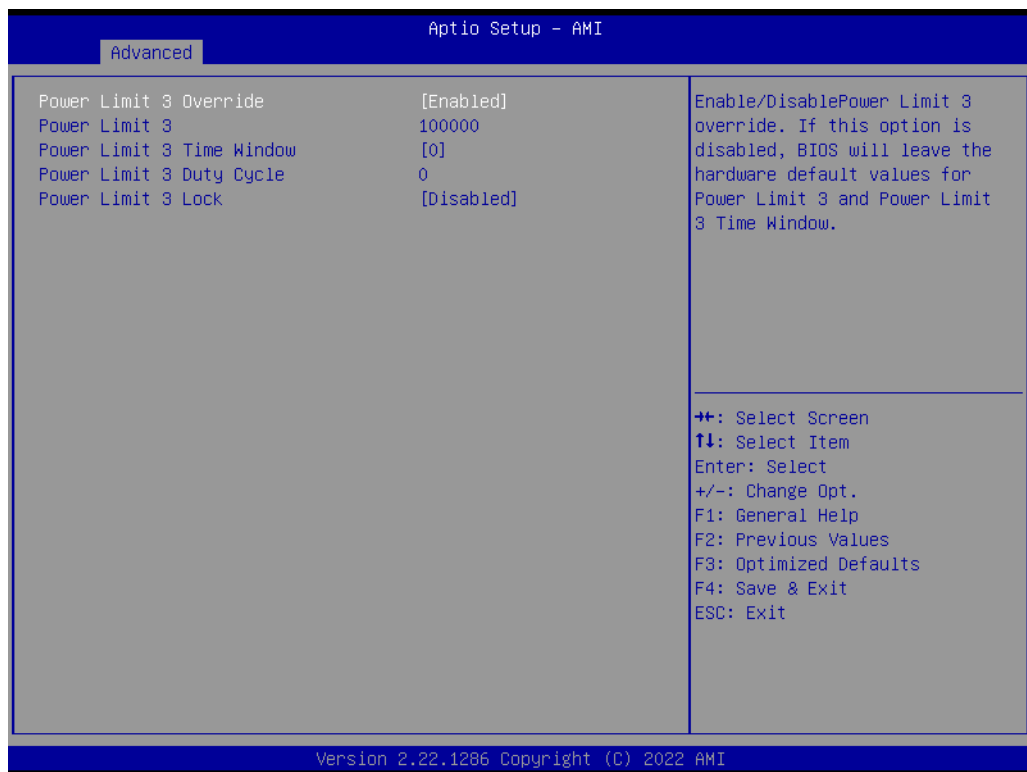

- Power Limit 3 Override
Enable/Disable Power Limit 3 override.
- Power Limit 3
Power Limit 3 in milliwatts.
- Power Limit 3 Time Window
Power Limit 3 Time Window value in milliseconds.

- Power Limit 3 Duty Cycle
Specify the duty cycle in percentage that the CPU is required to maintain over the configured time window. The range is 0-100.
- Power Limit 3 Lock
Power Limit 3 MSR 615h Lock. When enabled PL3 configurations are locked during OS operation. When disabled, PL3 configuration can be changed during OS operation.



- CFG Lock
Configure MSR 0xE2[15], CFG Lock bit.
- Overclocking Lock
Enable/Disable Overclocking Lock (BIT 20) in FLEX_RATIO(194) MSR.

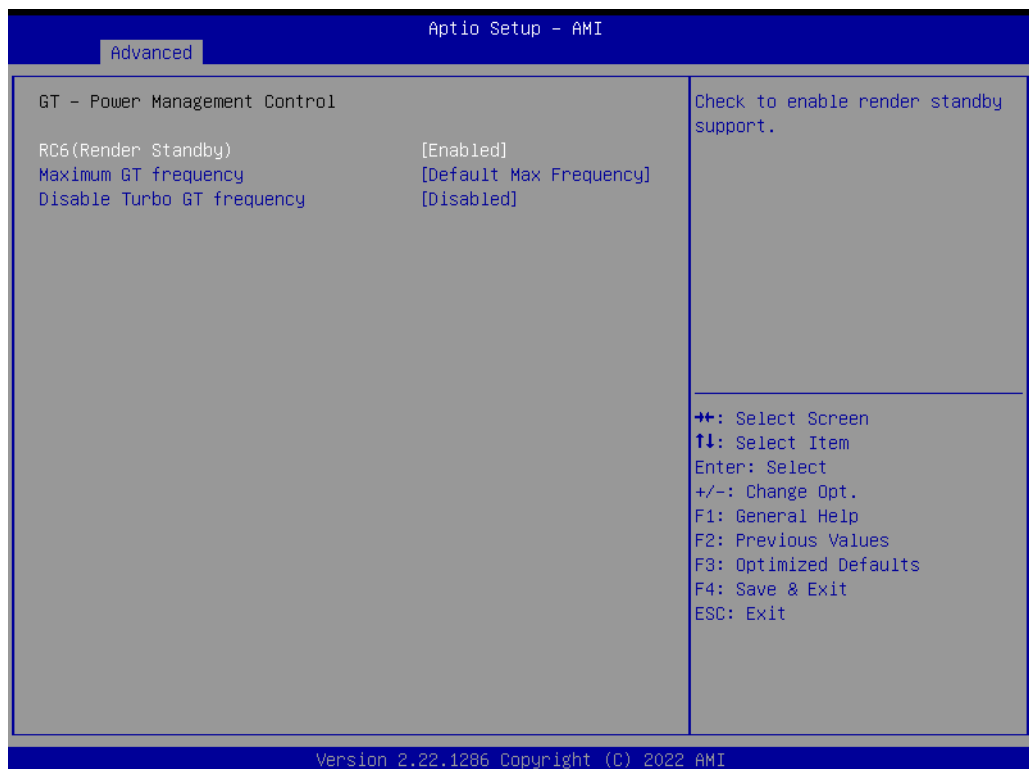
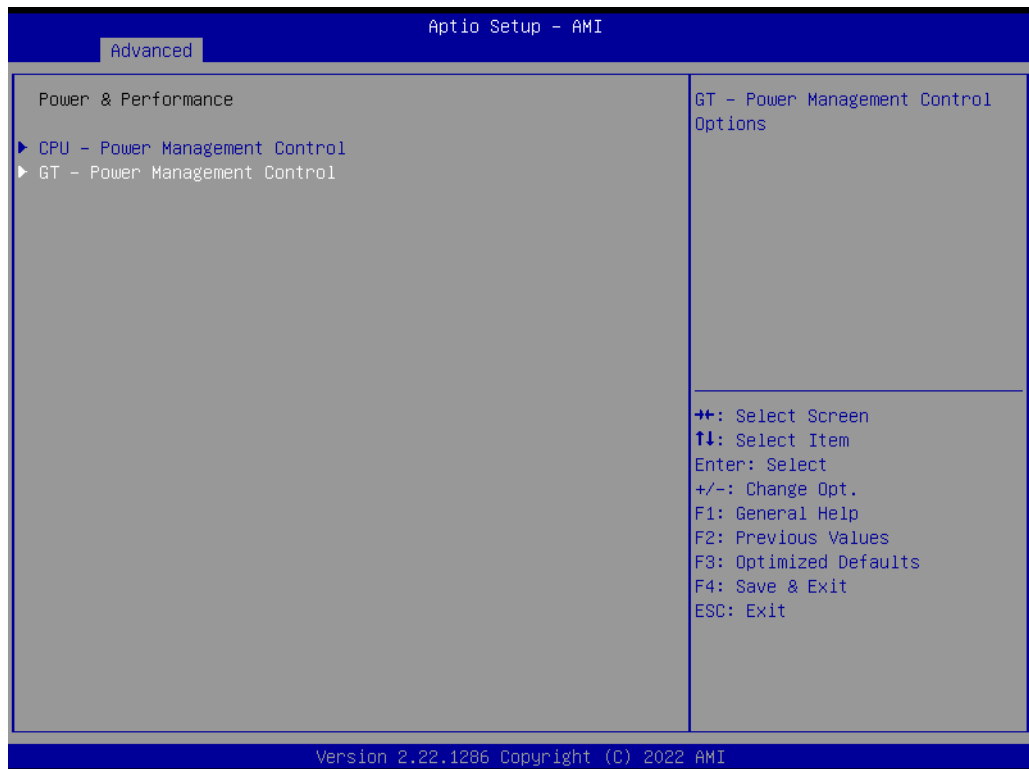

- RC6 (Render Standby)
Check to enable render standby support.

- Maximum GT frequency
Maximum GT frequency limited by the user.
- Disable Turbo GT frequency
Enabled: Disables Turbo GT frequency. Disabled: GT frequency is not limited.

3.2.2.3 PCH-FW Configuration

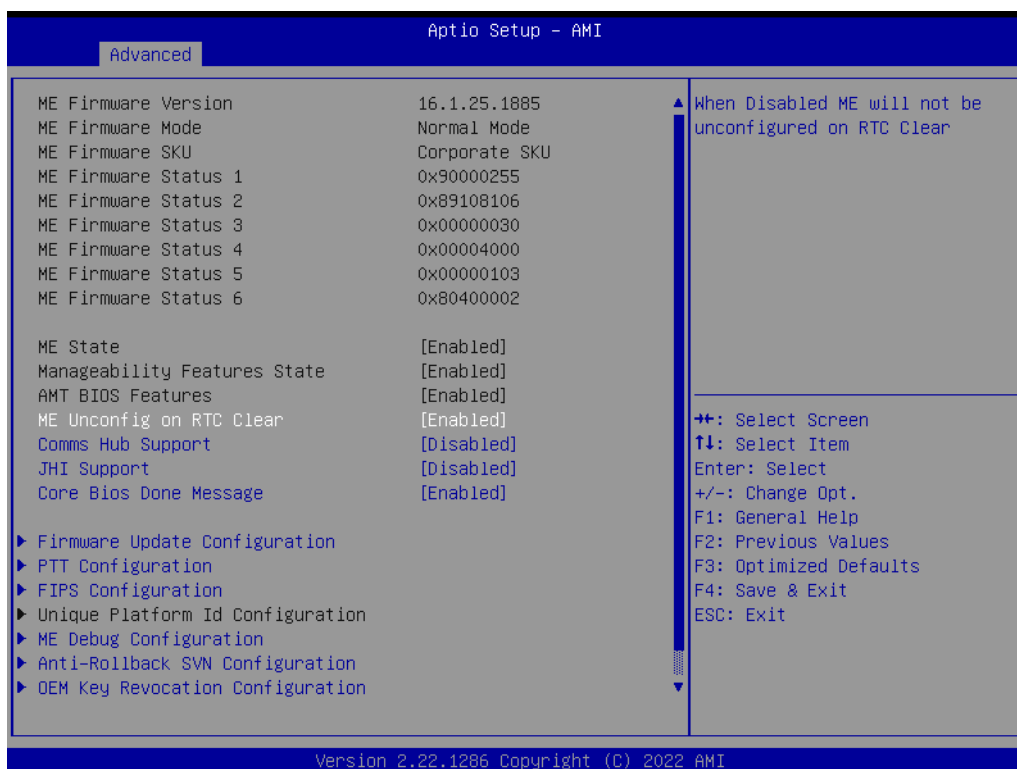
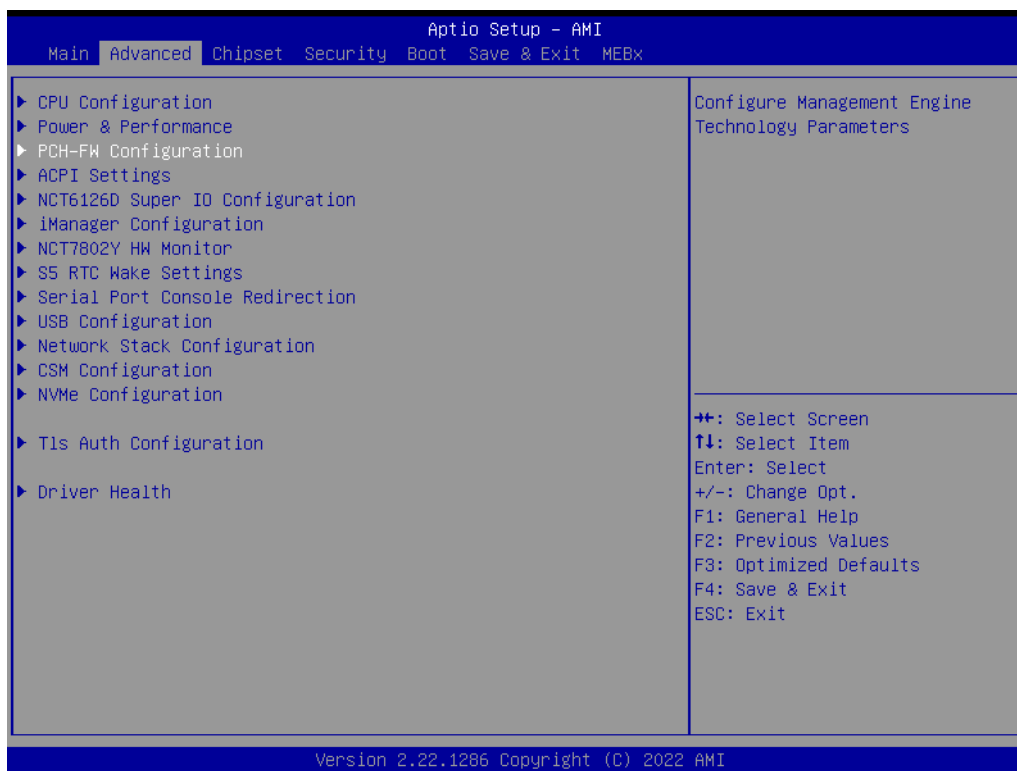

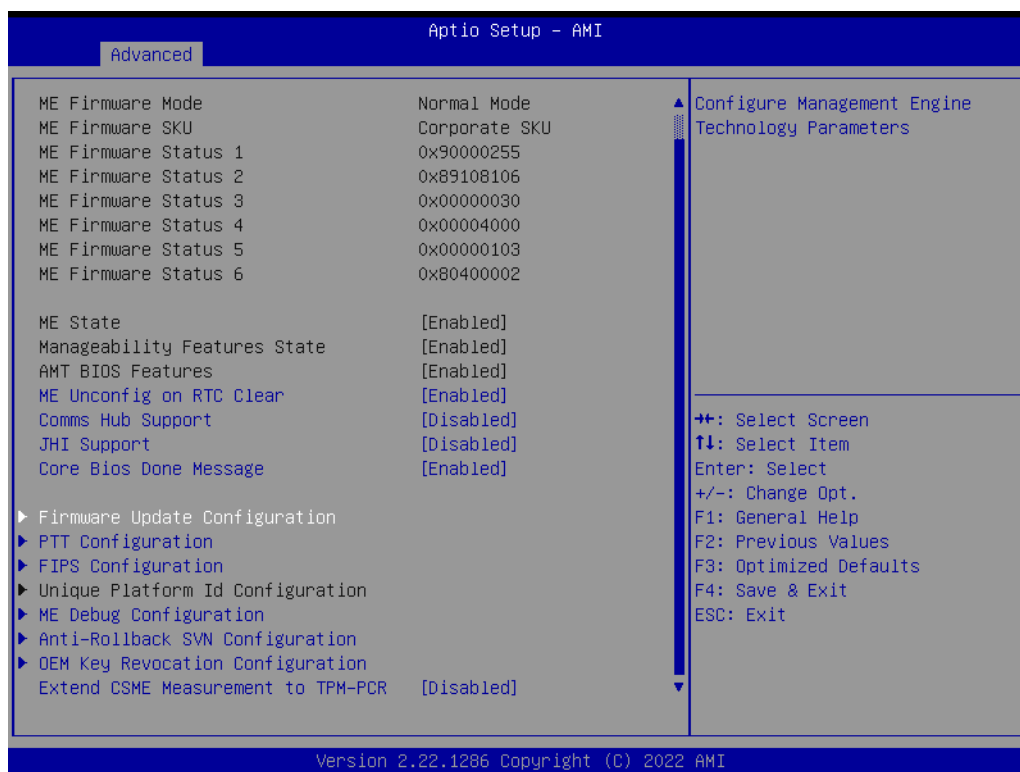

- **ME State**
When Disabled, ME will be put into ME Temporarily Disabled Mode.
- **Manageability Features State**
Enable/Disable Intel Manageability features.
- **AMT BIOS Features**
When disabled, AMT BIOS Features are no longer supported and user is no longer able to access MEBx Setup.
- **ME Unconfig on RTC Clear**
When Disabled, ME will not be unconfigured on RTC Clear.
- **Comms hub support**
Enables/Disables support for Comms Hub.
- **JHI support**
Enable/Disable Intel(R) DAL Host Interface Service (JHI)
- **Core BIOS Done Message**
Enable/Disable Core Bios Done message sent to ME

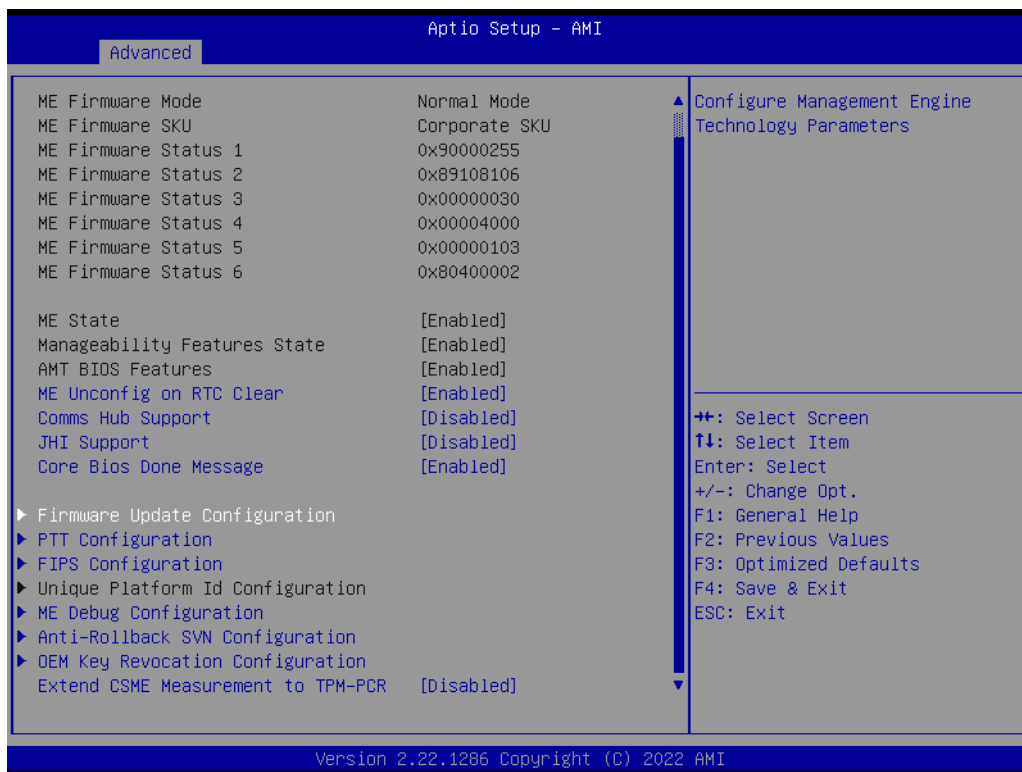

- Me FW Image Re-Flash
Enable/Disable Me FW Image Re-Flash function.
- FW Update
Enable/Disable ME FW Update function.

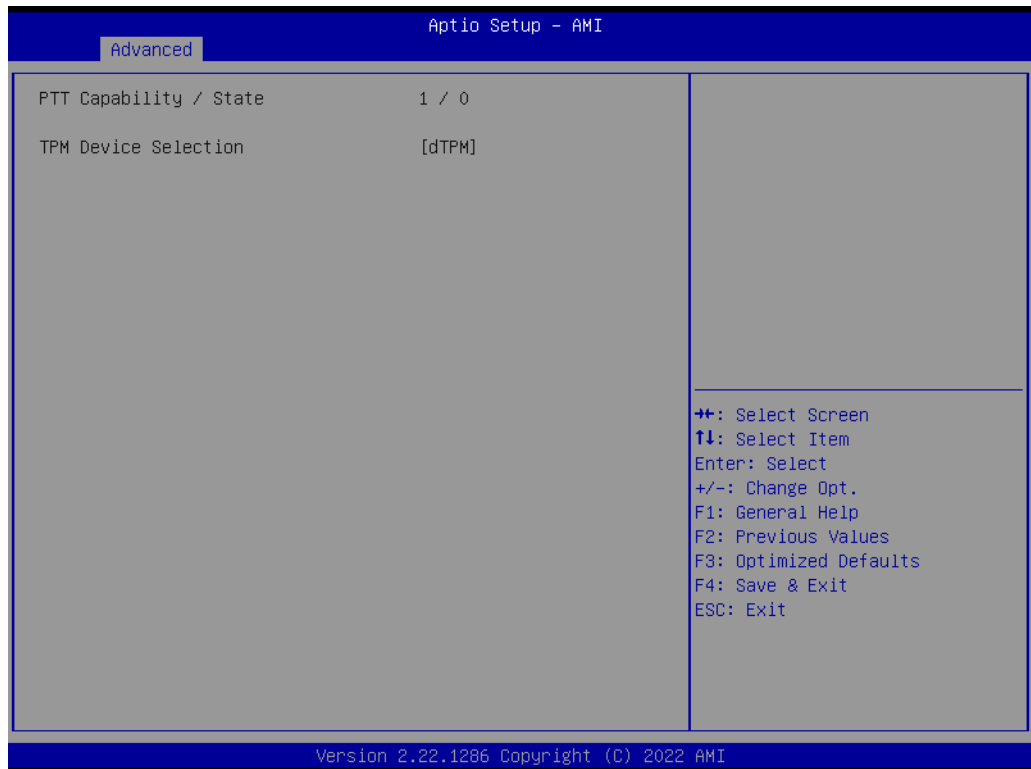
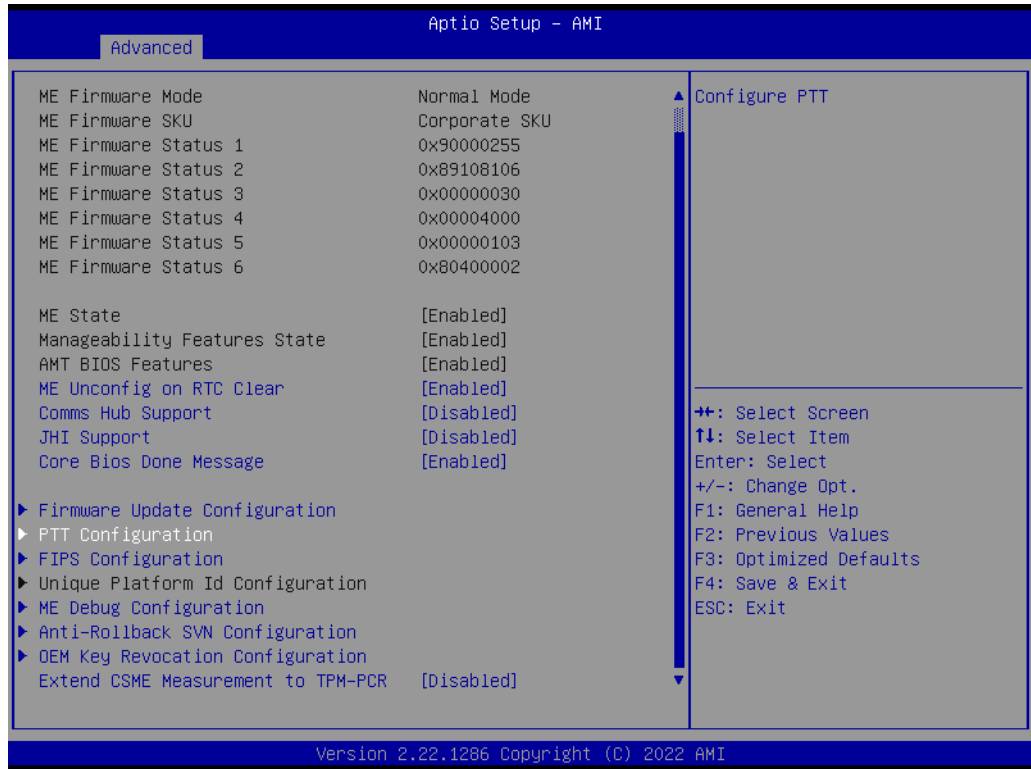

- TPM Device Selection
Configure TPM device.

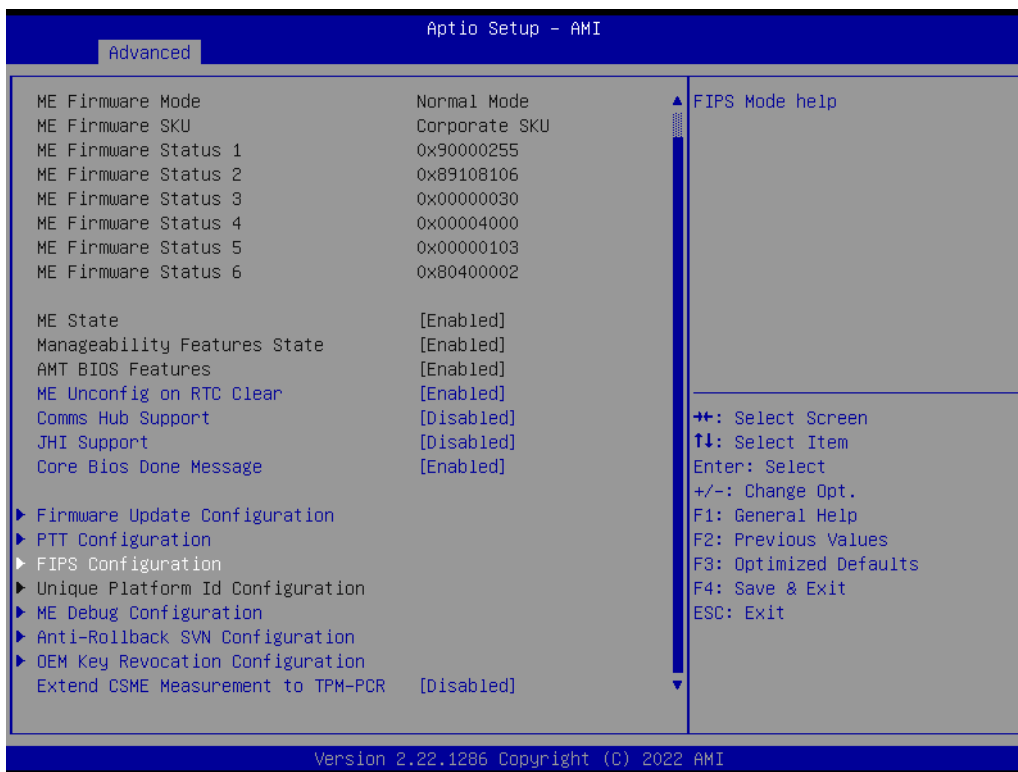

- FIPS mode select
- FIPS Mode configuration.

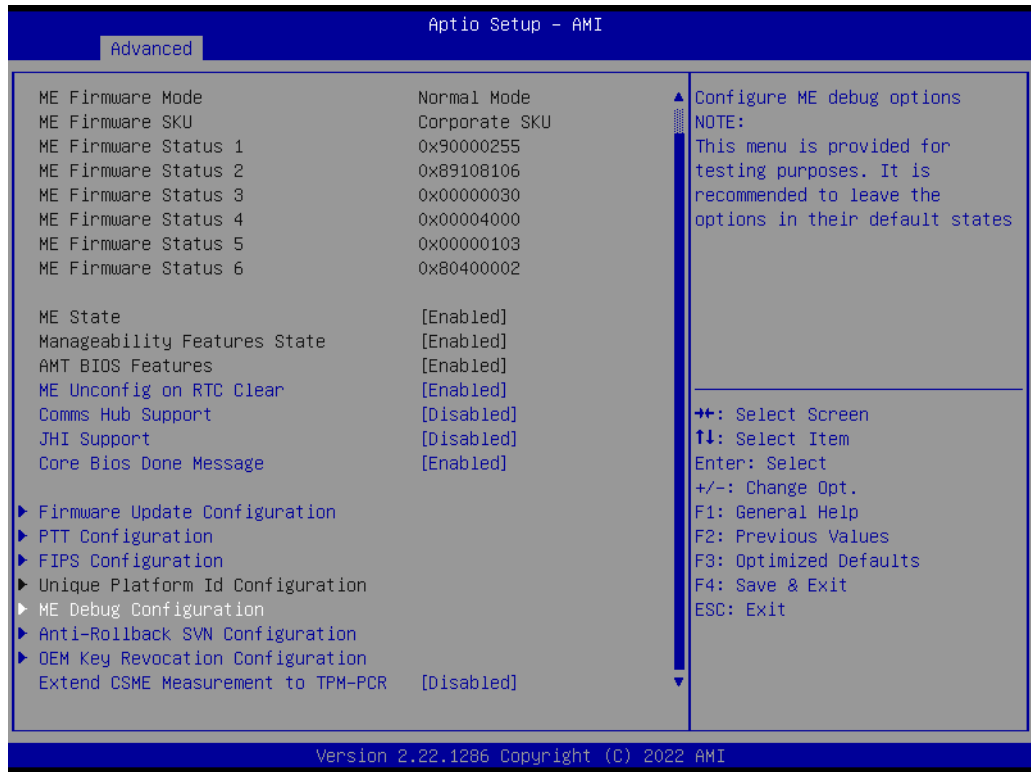

- Unique platform ID configuration
Configure Unique Platform ID Feature.

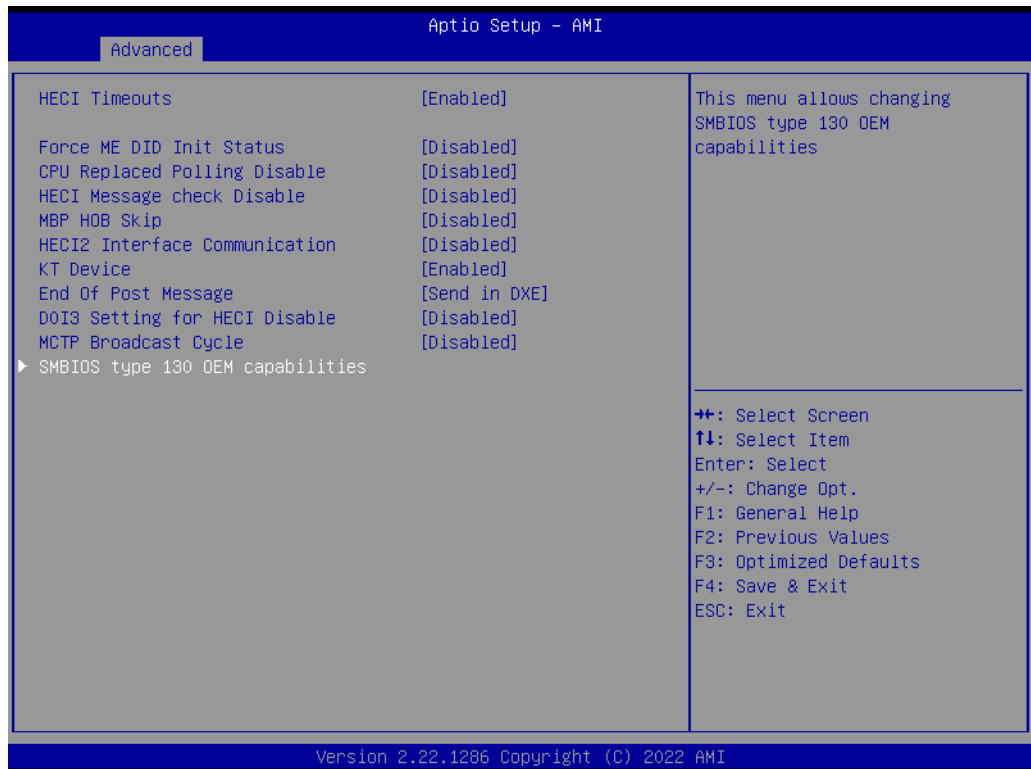



- HECI Timeouts
Unique platform ID configuration.
- Force ME DID Init Status
Unique platform ID configuration.
- CPU Replaced Polling Disable
Setting this option disables CPU replacement polling loop.
- HECI Message check Disable
Setting this option disables message check for Bios Boot Path when sending.
- MBP HOB Skip
Setting this option will skip MBP HOB.
- HECI2 Interface Communication
Adds and Removes HECI2 Device from PCI space.
- KT Device
Enable/Disable KT Device.
- End Of Post Message
Enable/Disable End of Post message sent to ME.
- D0I3 Settings for HECI Disable
Setting this option disables setting D0I3 bit for all HECI devices.
- MCTP Broadcast Cycle
Enable/Disable Management Component Transport Protocol Broadcast Cycle and Set PMT as Bus Owner.
- BIOS Reflash Capability State
Change BIOS Reflash Capability State.
- BIOS Boot to Setup Capability State
Change BIOS Boot to Setup Capability State.
- BIOS Pause Before Booting Capability State
Change BIOS Pause Before Booting Capability State.

- BIOS Secure Boot Capability Exposure to FW State
Change BIOS Secure Capability Exposure State to FW. This does not affect SecureBoot as such.
- vPro TBT Dock Support
Enable/Disable vPro TBT Dock Support. Note: for the change to take effect, need to put system into G3 state then resume.

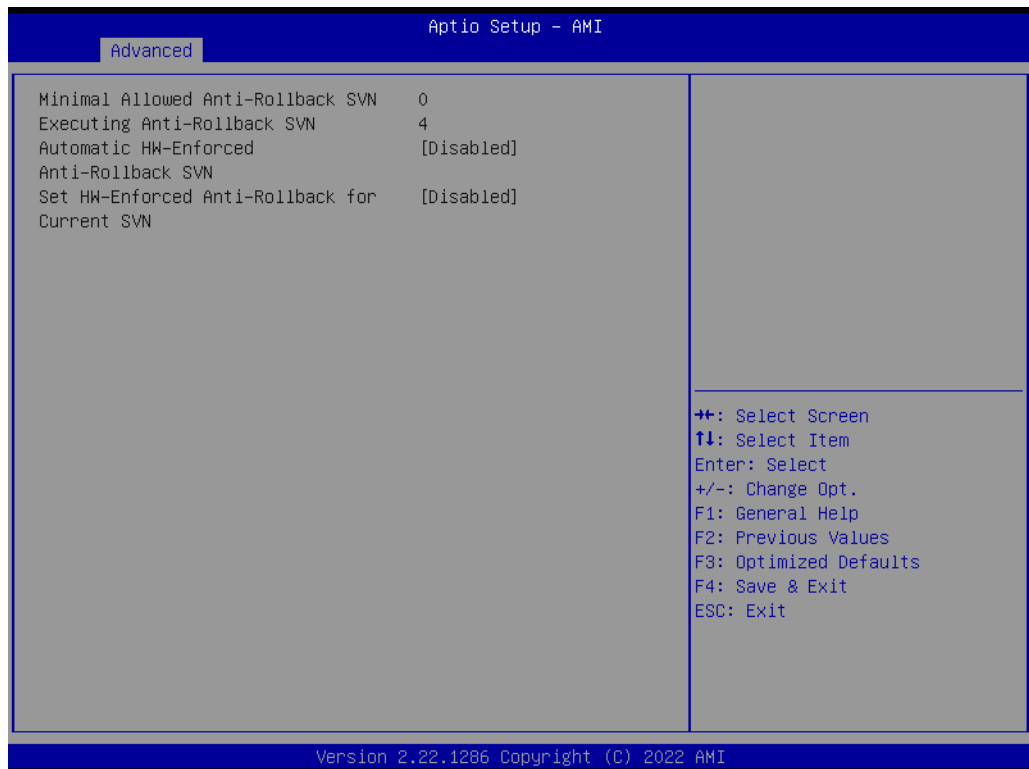
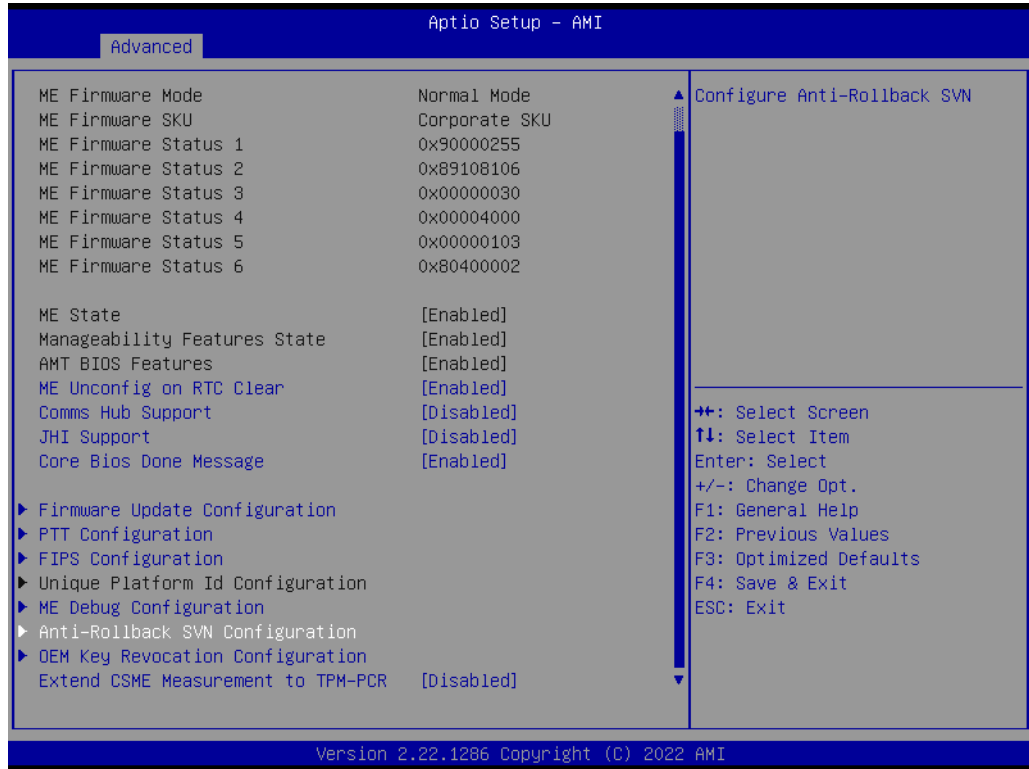

- Automatic HW-Enforced Anti-Rollback SVN
When enabled, hardware-enforced Anti-Rollback mechanism is automatically activated: once ME FW was successfully run on a platform, FW with lower ARB-SVN will be blocked from execution.
- Set HW-Enforced Anti-Rollback for Current SVN
Enable hardware-enforced Anti-Rollback mechanism for current ARB-SVN value. FW with lower ARB-SVN will be blocked from execution. The value will be restored to disable after the command is sent.

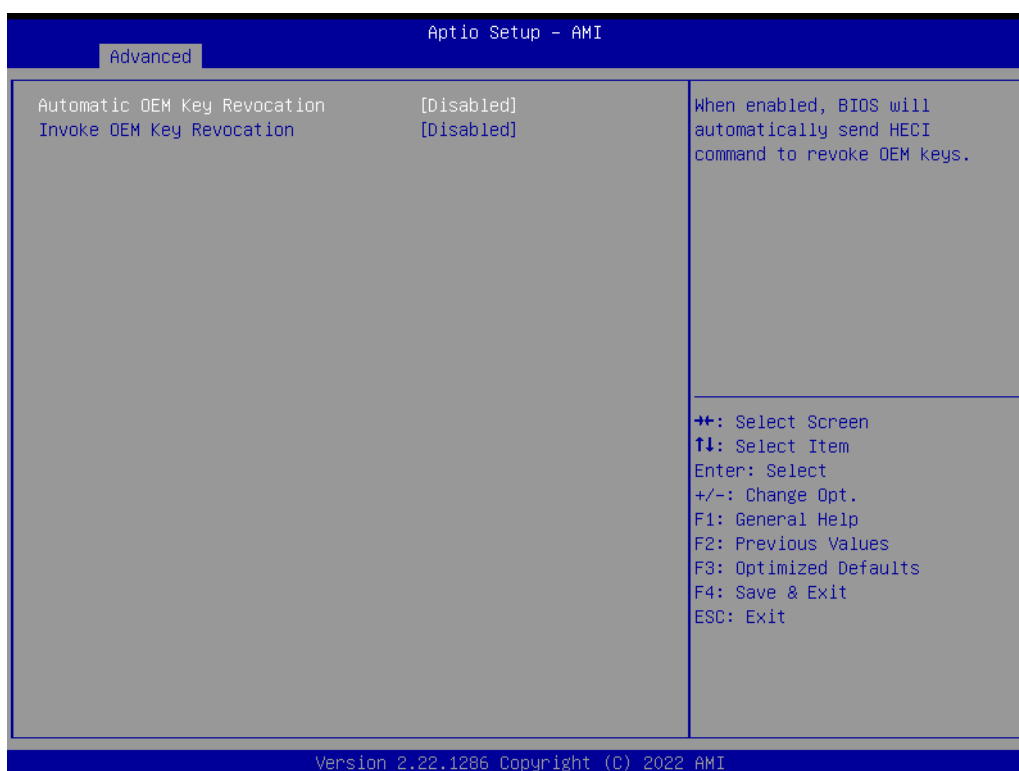
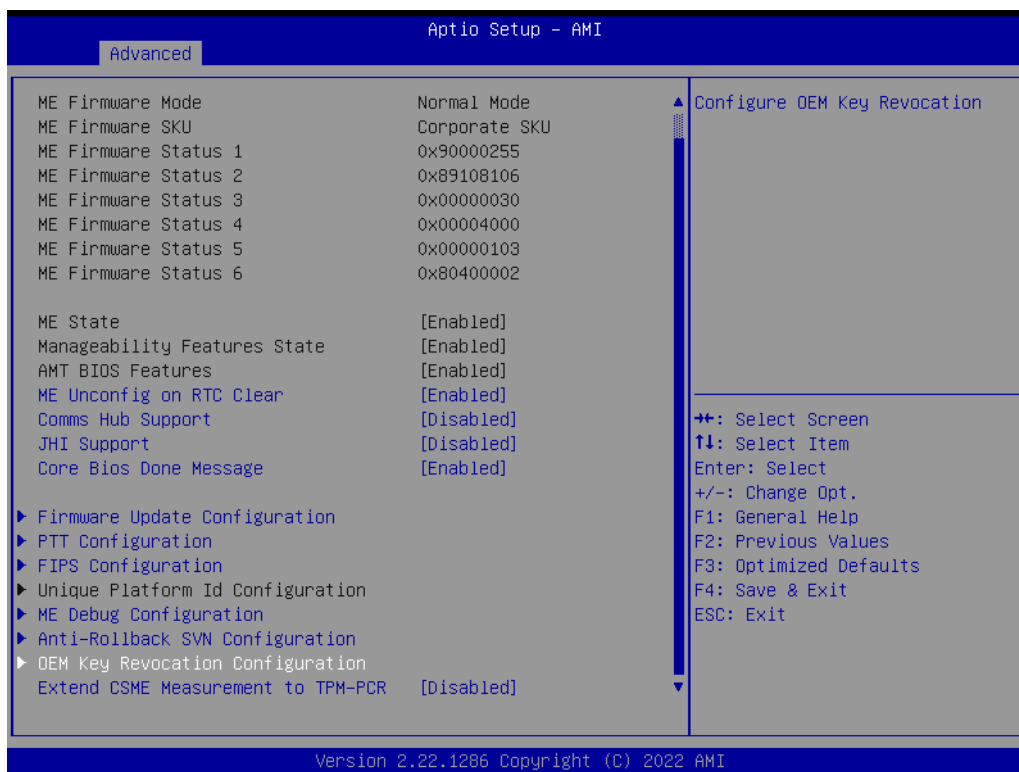

- Automatic OEM Key Revocation
When enabled, BIOS will automatically send HECI command to revoke OEM keys.
- Invoke OEM Key Revocation
A Heci command will be sent to revoke the OEM key.

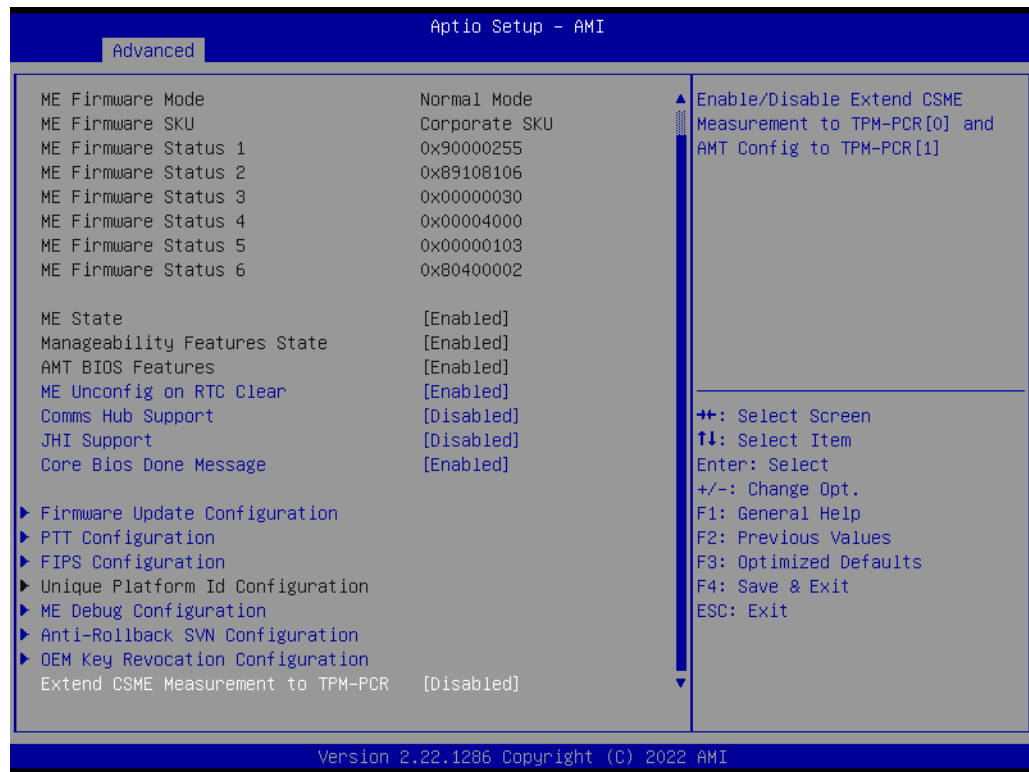

- Extend CSME Measurement to TPM-PCR
Enable/Disable Extend CSME Measurement to TPM-PCR[0] and AMT Config to TPM-PCR[1].

3.2.2.4 ACPI Settings

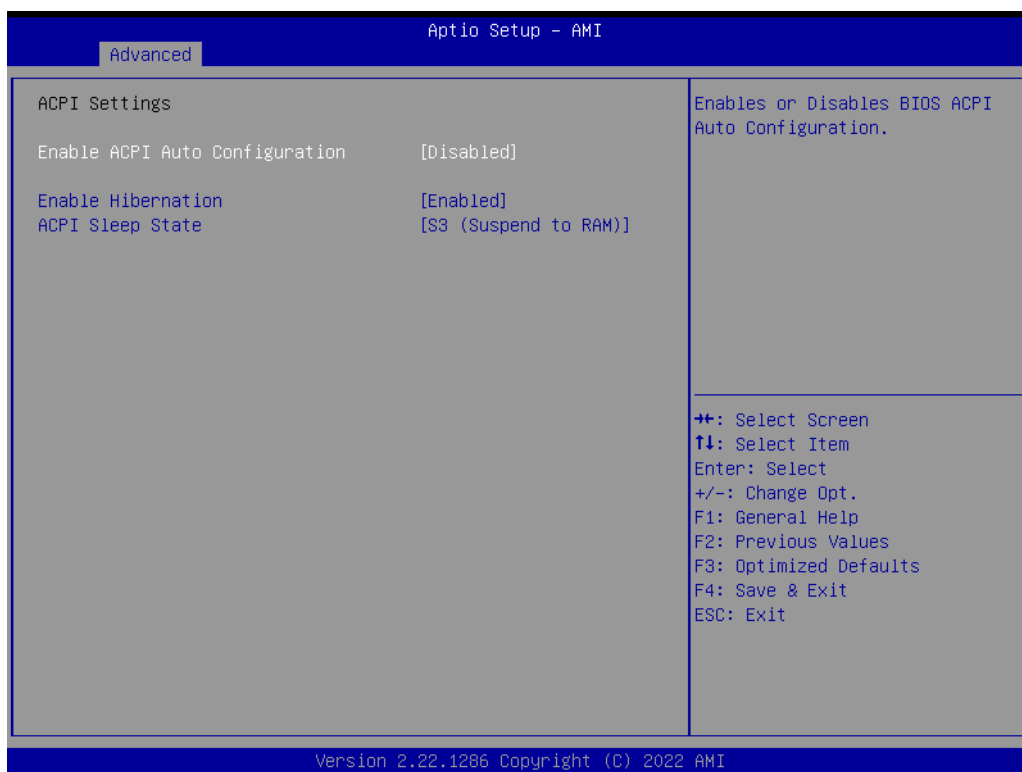
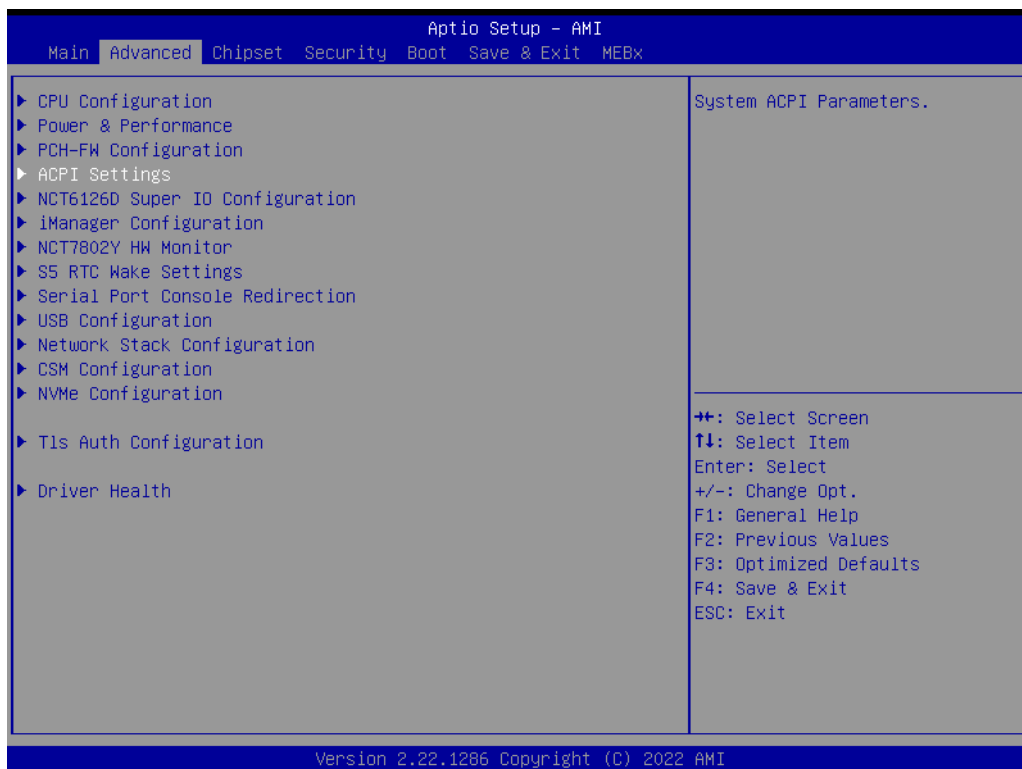

- **Enable ACPI Auto Configuration**
Enables or Disables BIOS ACPI Auto Configuration.
- **Enable Hibernation**
Enables or Disables System's ability to Hibernation (OS/S4 Sleep State).

■ **ACPI Sleep State**

Select the highest ACPI sleep state the system will enter when the SUSPEND button is pressed.

3.2.2.5 NCT61260 Super I/O Configuration

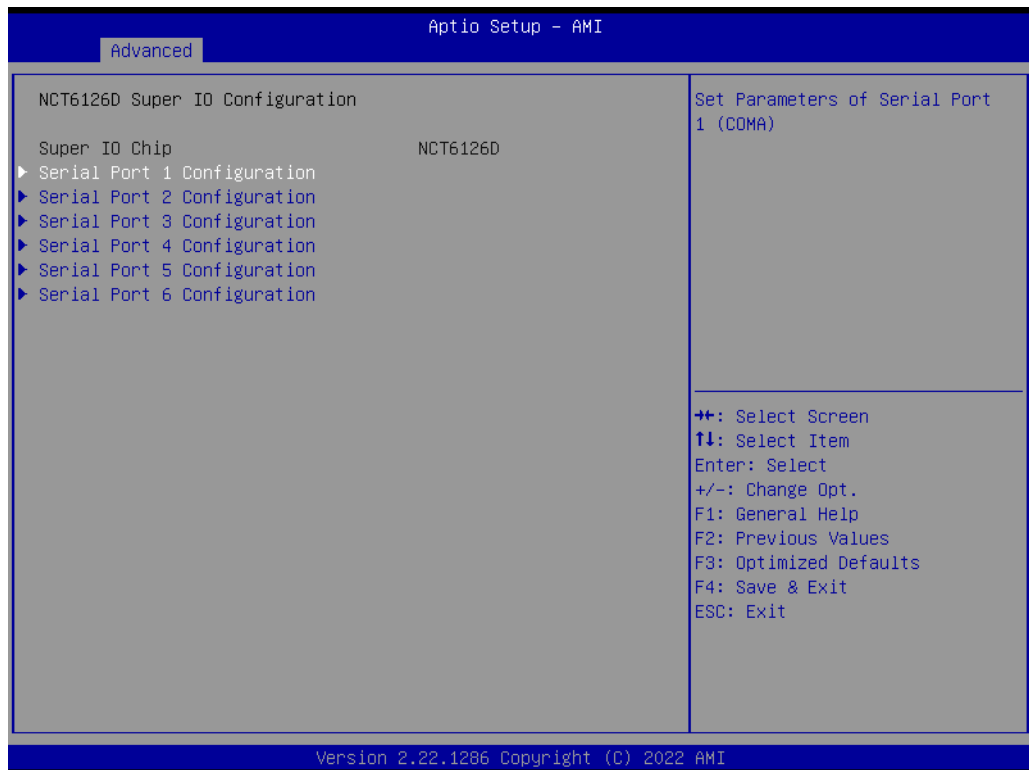
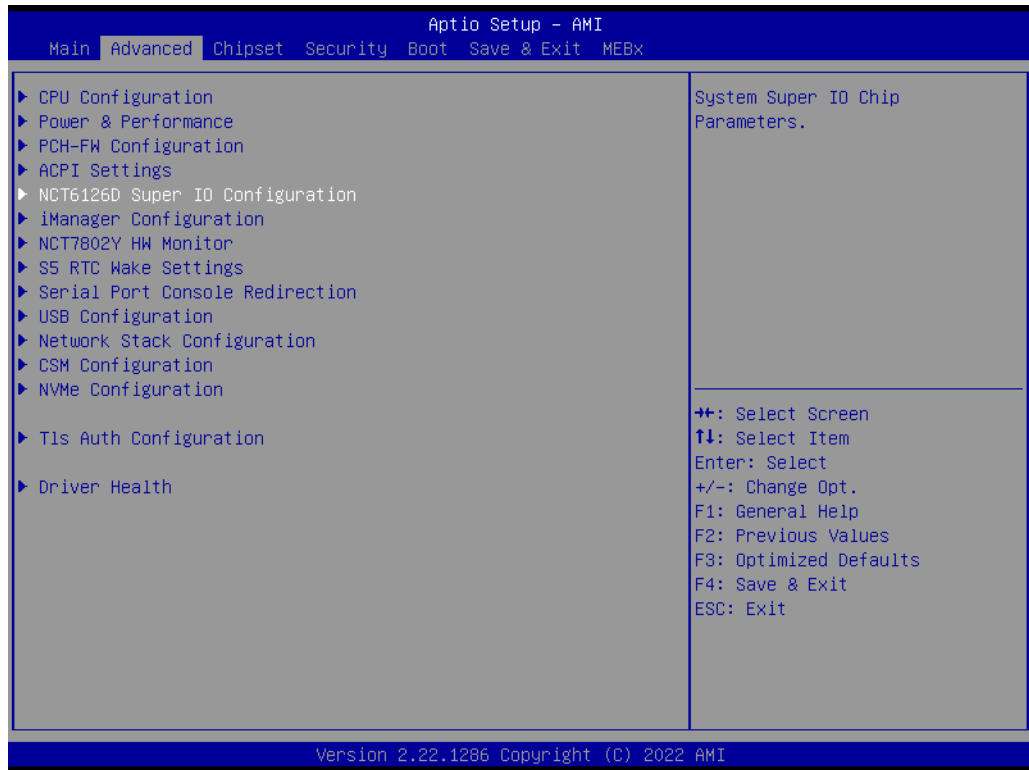

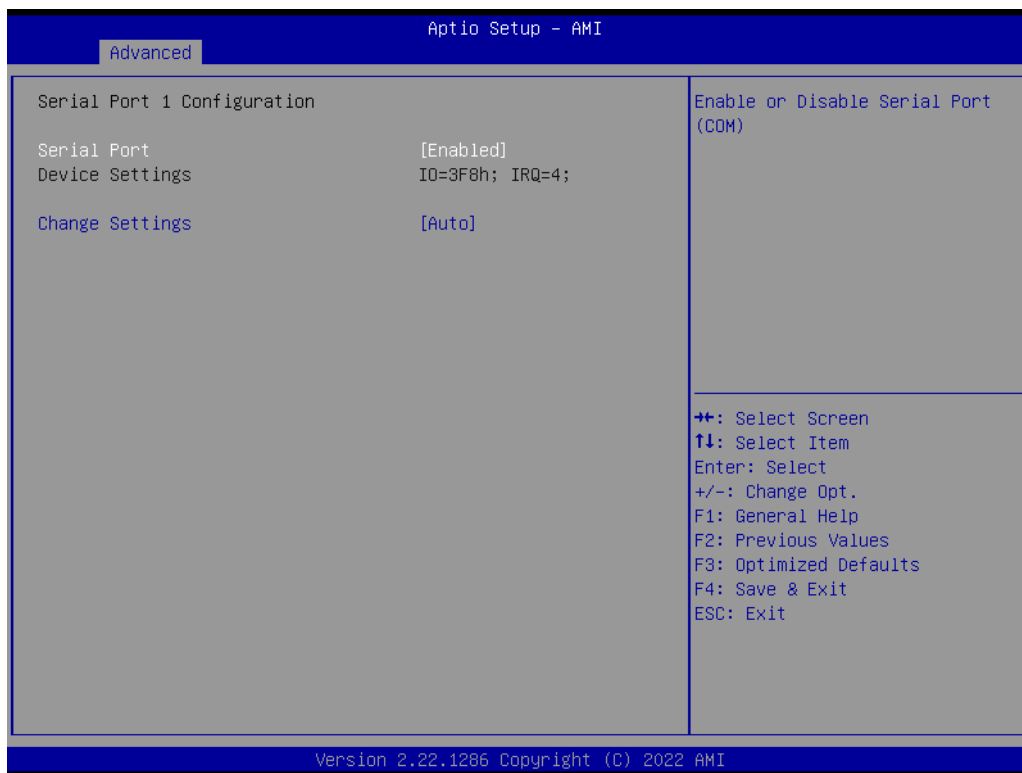

- **Serial Port**
Enable or Disable Serial Port.
- **Change Settings**
Select optimal settings for a super IO Device.
- **COM3~6 Mode**
COM Mode Select.

3.2.2.6 iManager Configuration

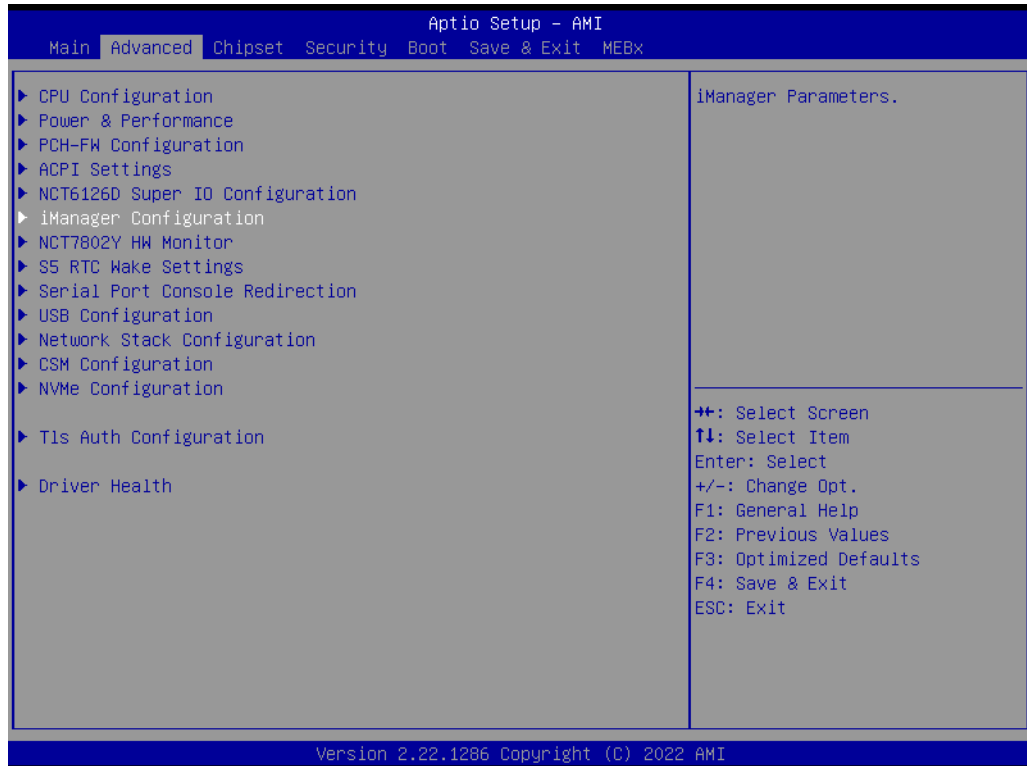

- **Serial Port 7 Configuration**
Set Parameters of Serial Port 7.
- **Serial Port 8 Configuration**
Set Parameters of Serial Port.
- **Hardware Monitor**
Monitor hardware status.
- **Watch Dog Timer Configuration**
Watch Dog Timer Configuration Page.
- **ACPI Report Method Configuration**
Select ACPI Reporting Method for EC Devices.
- **Digital I/O Configuration**
Configure the digital I/O pins.

3.2.2.7 NCT7802Y HW Monitor

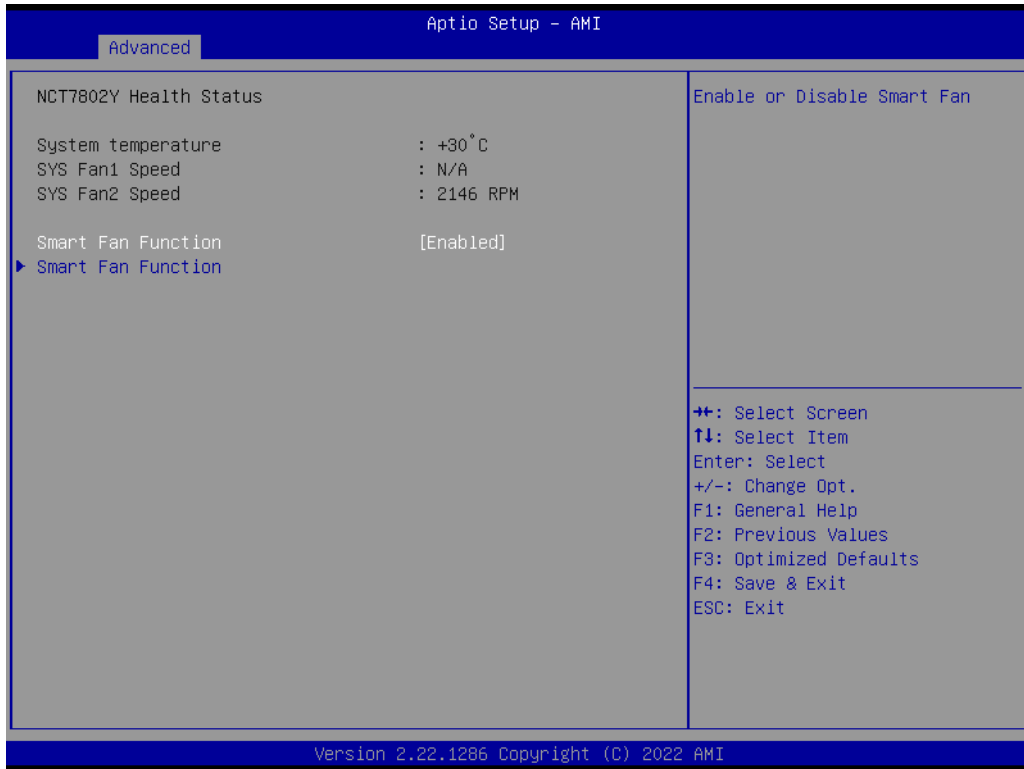
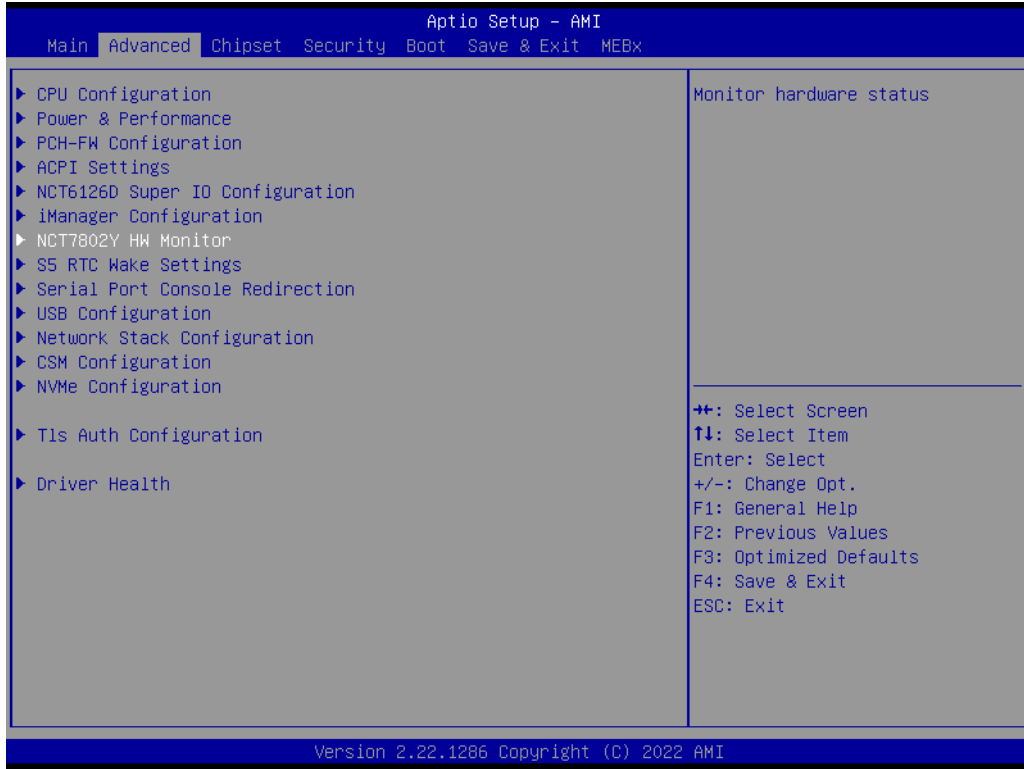

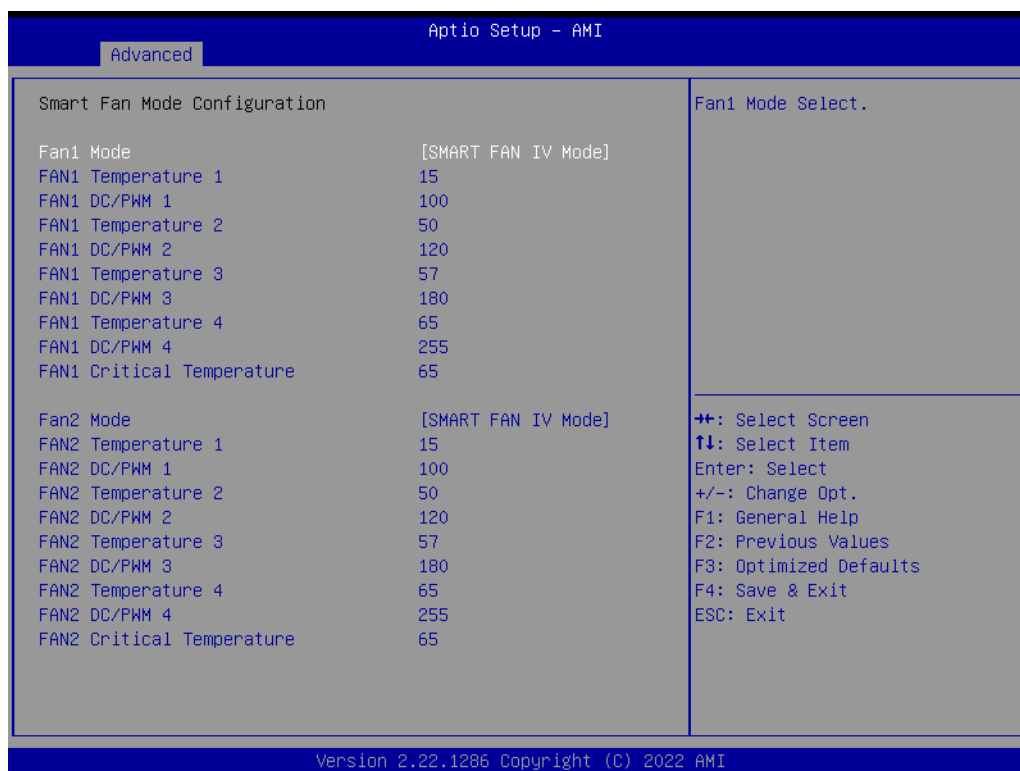
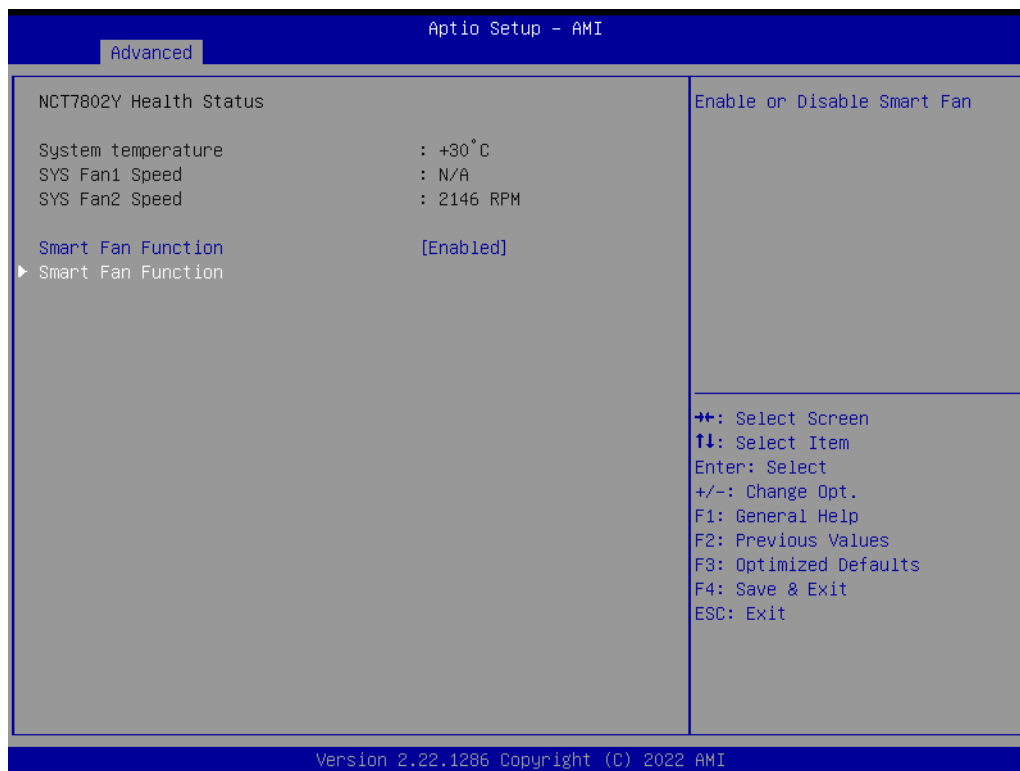

- **Smart Fan Function**
Enable or Disable Smart Fan.
- **Fan Mode**
Fan Mode Select.
- **FAN Temperature 1**
Input the System Smart Fan IV Temperature 1.

- **FAN DC/PWM 1**
Input the System Smart Fan IV DC/PWM 1 Value.
- **FAN Temperature 2**
Input the System Smart Fan IV Temperature 2.
- **FAN DC/PWM 2**
Input the System Smart Fan IV DC/PWM 2 Value.
- **FAN Temperature 3**
Input the System Smart Fan IV Temperature 3.
- **FAN DC/PWM 3**
Input the System Smart Fan IV DC/PWM 3 Value.
- **FAN Temperature 4**
Input the System Smart Fan IV Temperature 4.
- **FAN DC/PWM 4**
Input the System Smart Fan IV DC/PWM 4 Value.
- **FAN Critical Temperature**
Input the System Smart IV Critical Temperature.

3.2.2.8 S5 RTC Wake Settings

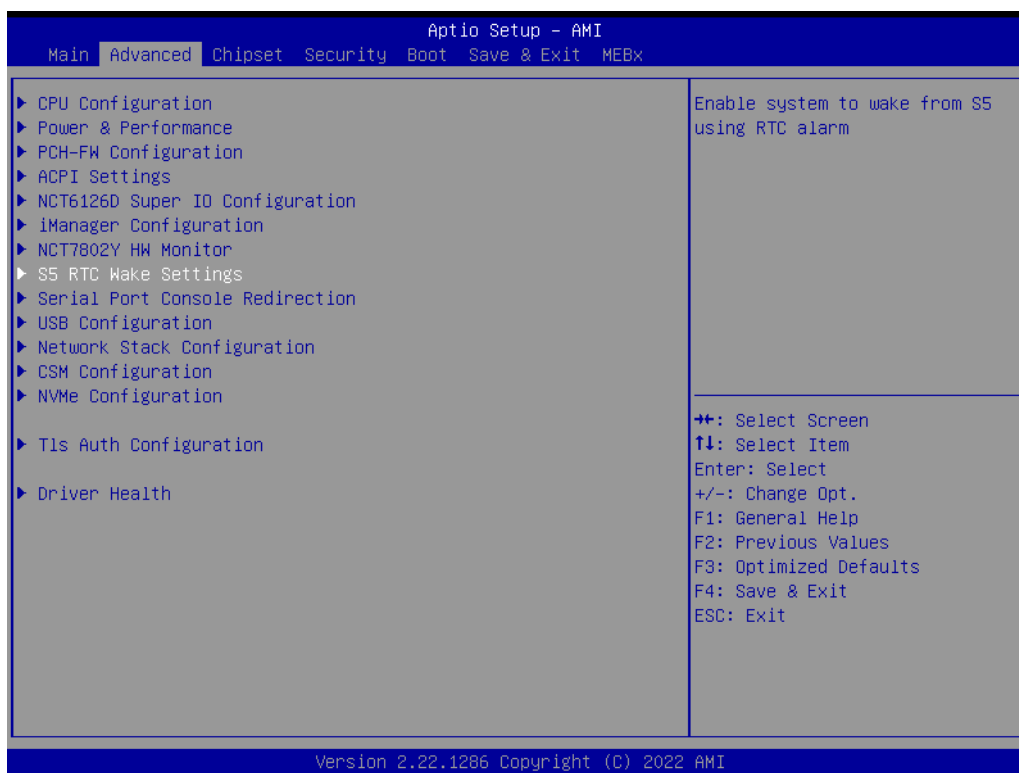

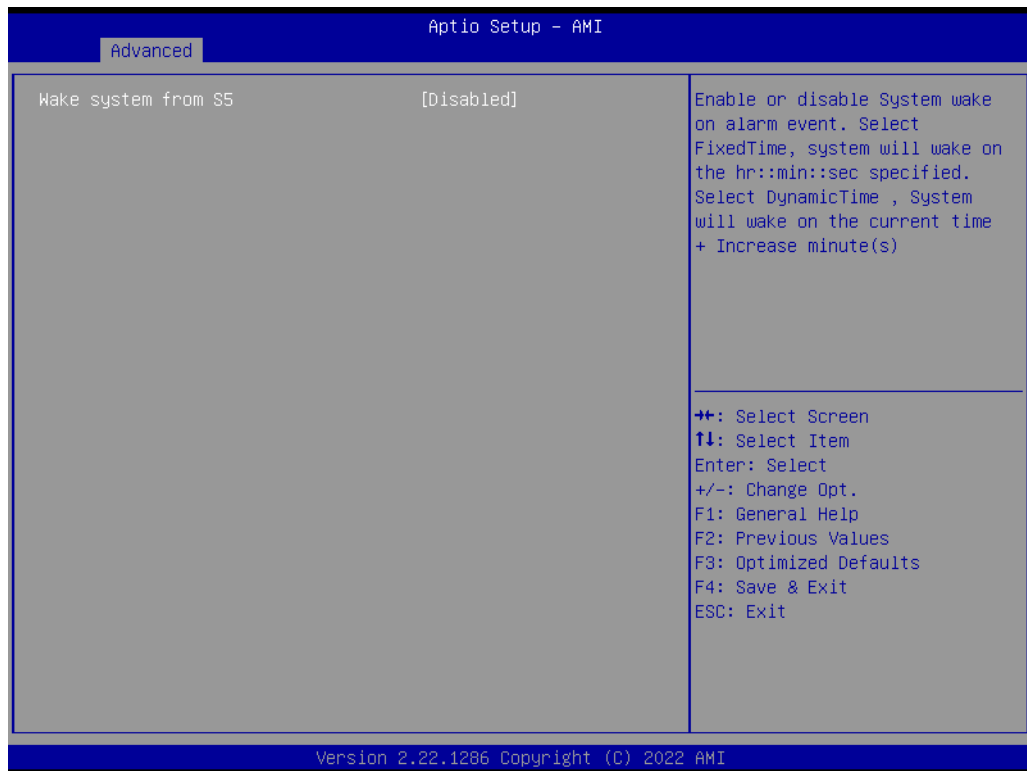

- **Wake system from S5**
Enable or Disable system wake on alarm event.

3.2.2.9 Serial Port Console Redirection

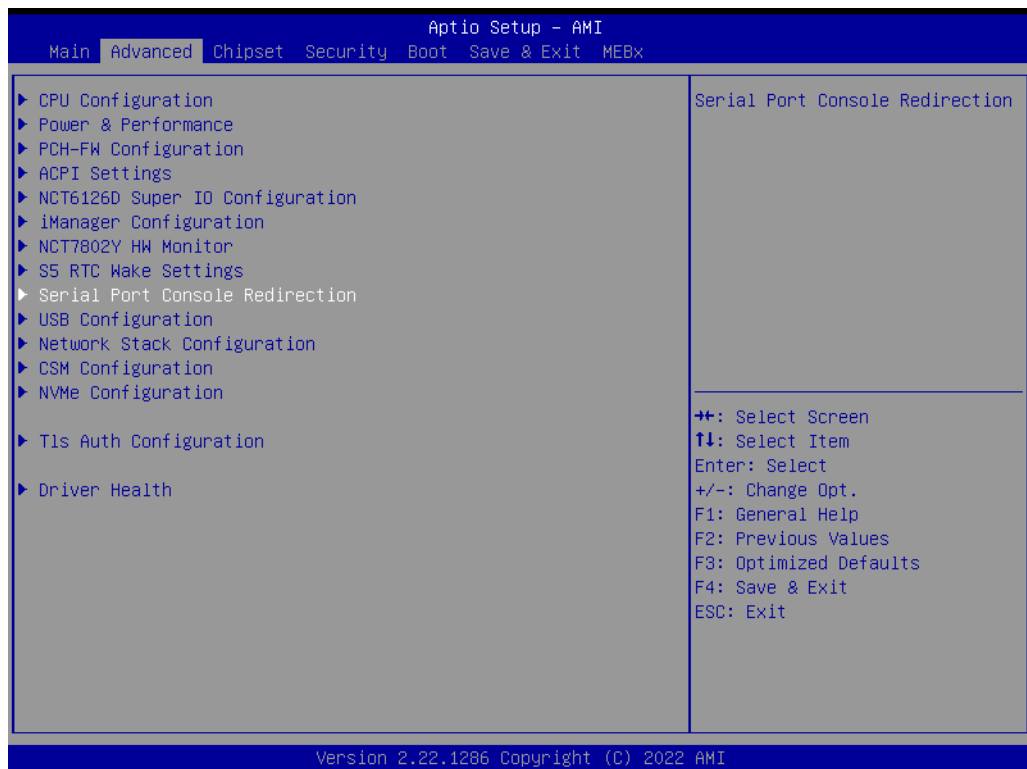



- **Console Redirection**
Console Redirection Enable or Disable.
- **Legacy Console Redirection Settings**
Legacy Console Redirection Settings.
- **Console Redirection EMS**
Console Redirection Enable or Disable.

3.2.2.10 USB Configuration

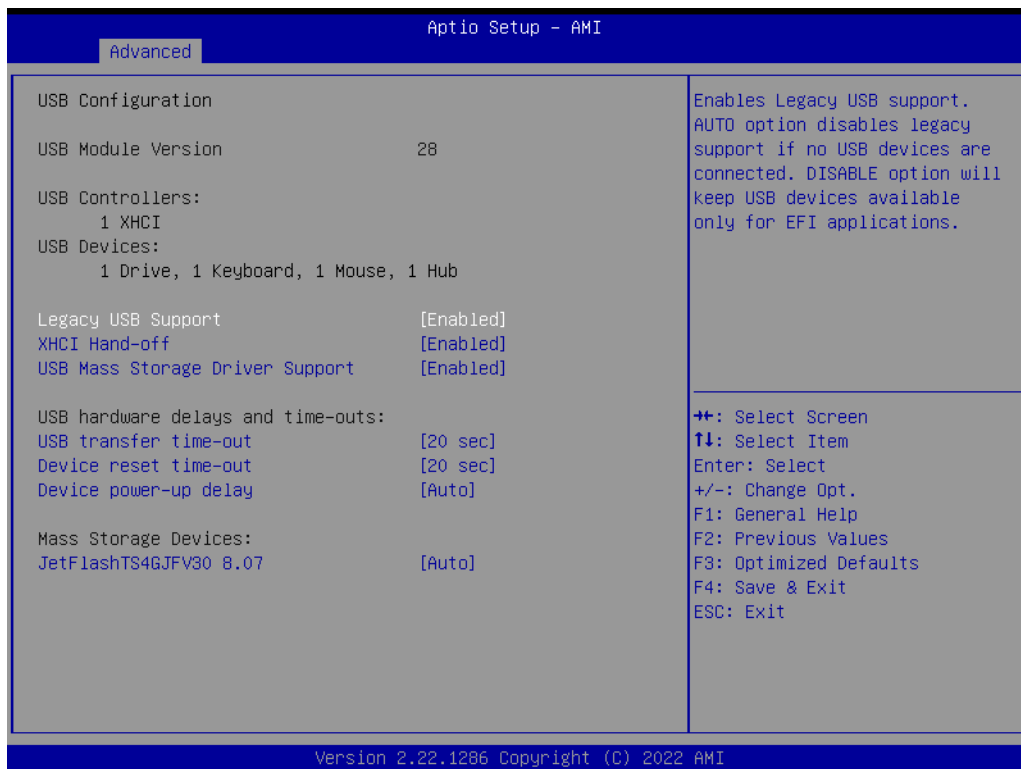
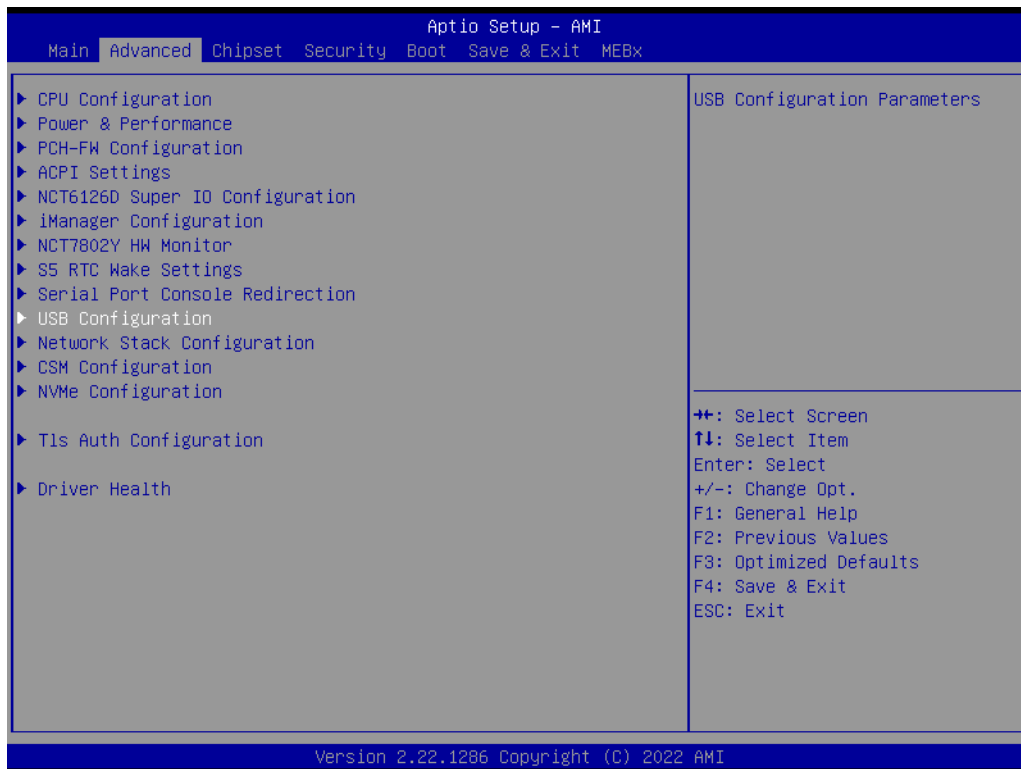

- **Legacy USB Support**
Enables Legacy USB support.
- **XHCI Hand-off**
This is a workaround for OS without XHCI hand-off support.
- **USB Mass Storage Device Configuration**

Configure the USB Mass Storage Devices.

- **USB transfer time-out**
The time-out value for Control, Bulk, and Interrupt transfers.
- **Device reset time-out**
USB mass storage device Start Unit command time-out.
- **Device power-up delay**
Maximum time the device will take before it properly reports itself to the Host Controller.

3.2.2.11 Network Stack Configuration

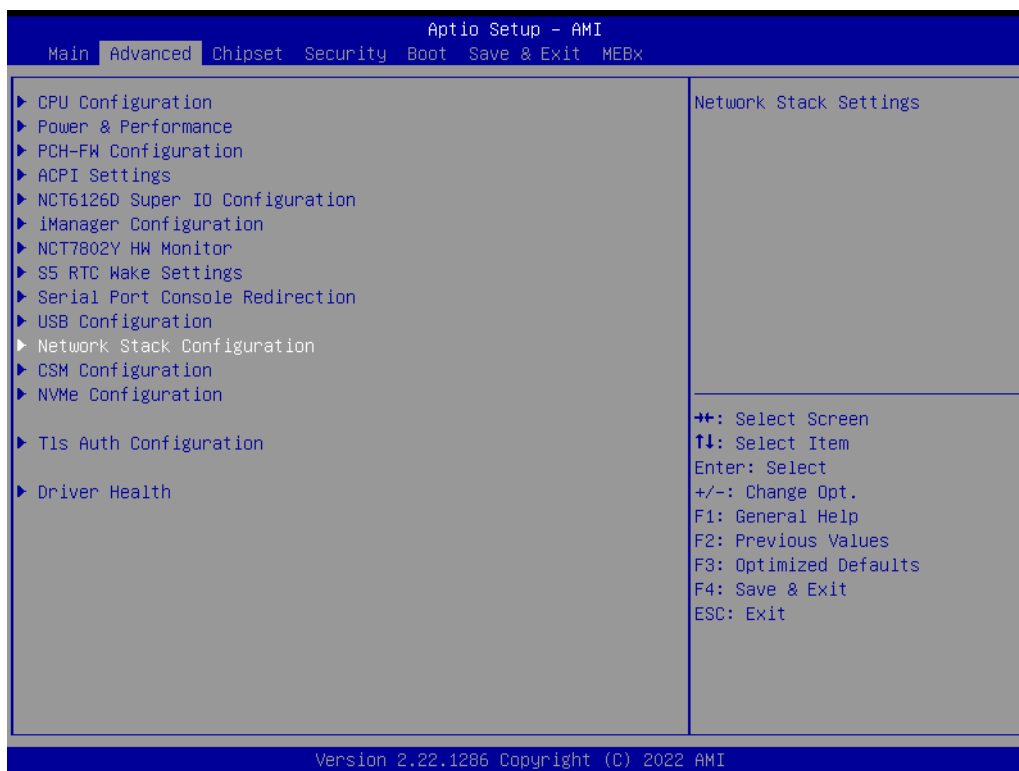

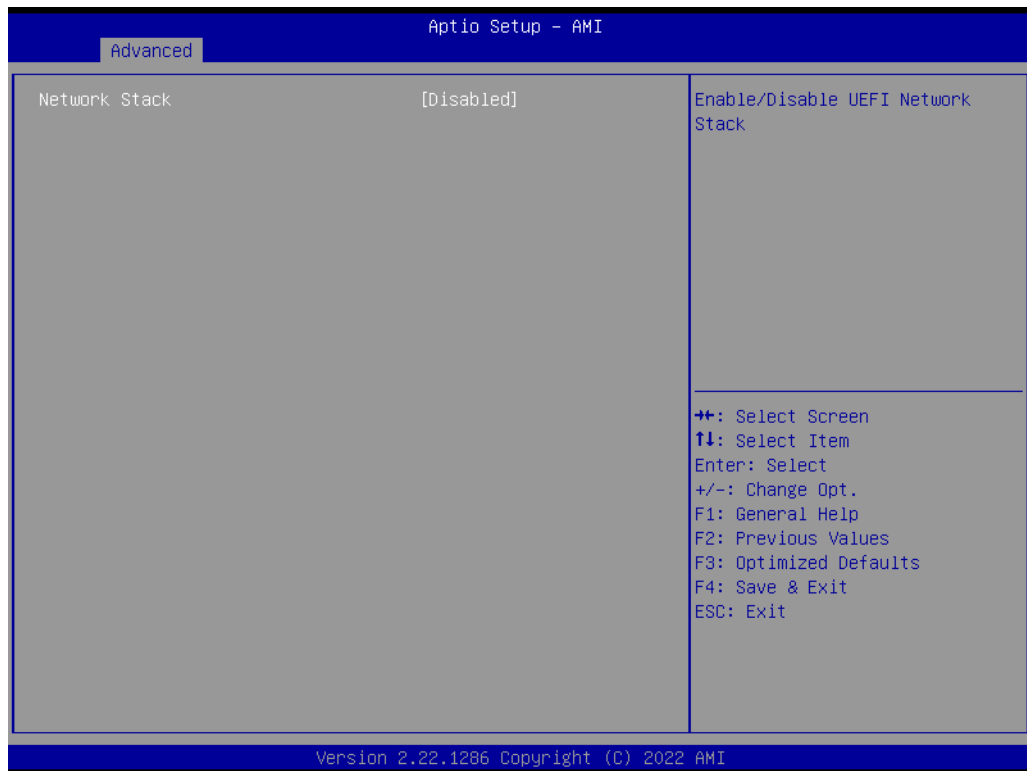

- **Network Stack**
Enable/Disable UEFI Network Stack.

3.2.2.12 CSM Configuration

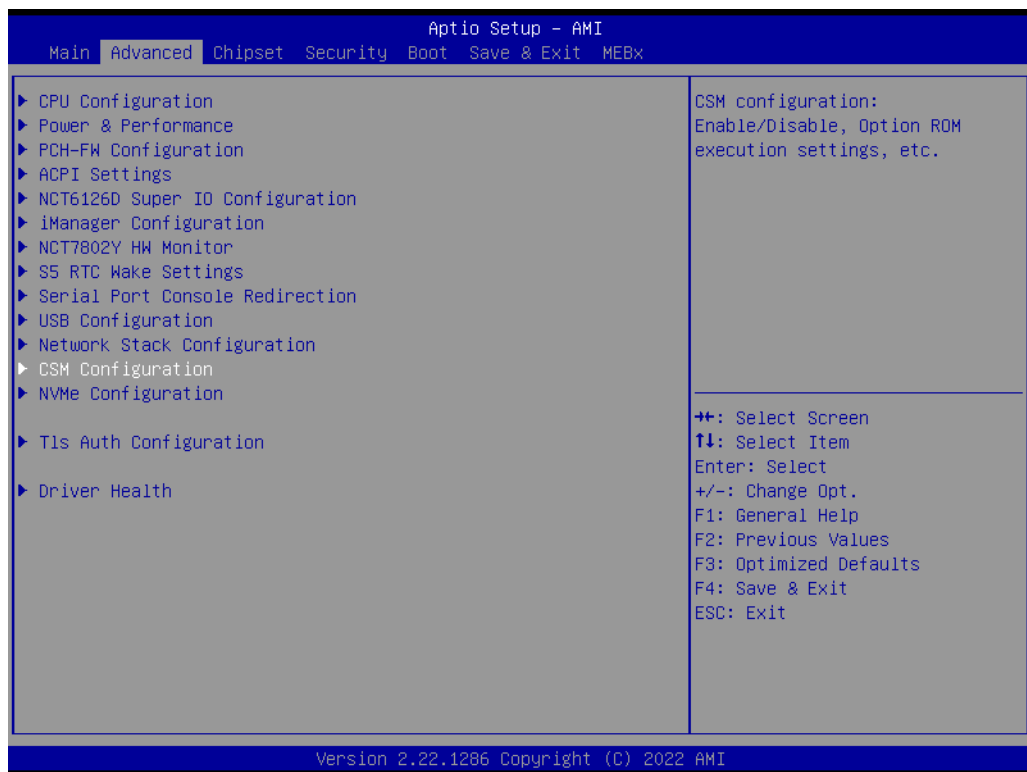

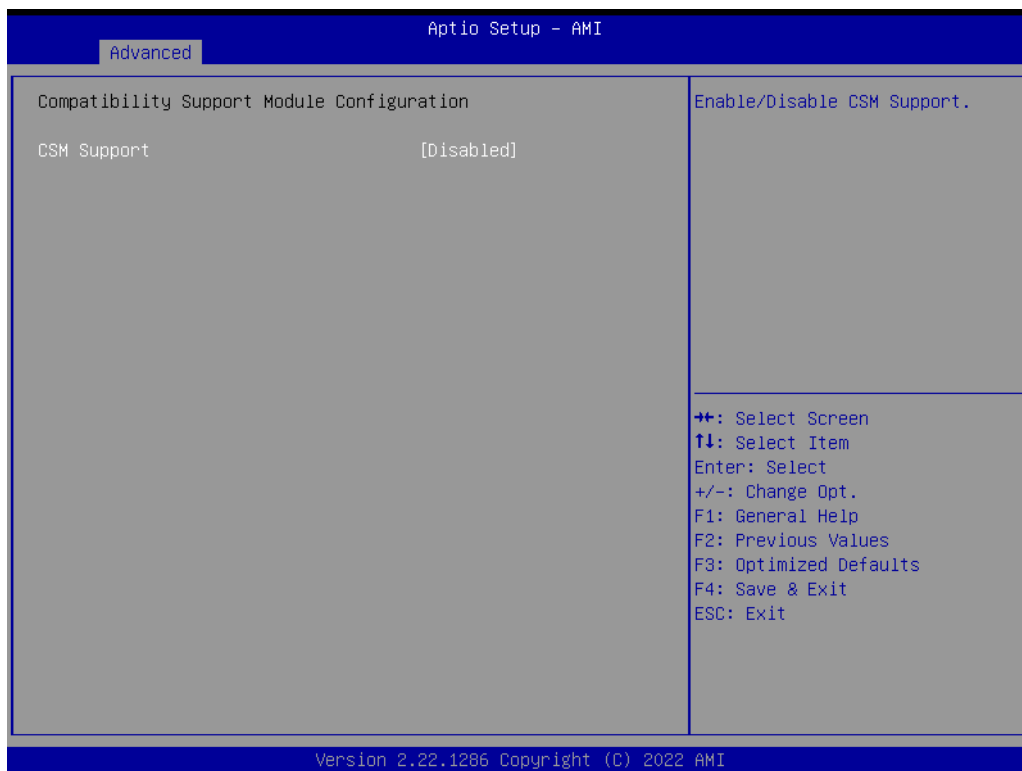

- **CSM Support**
Enable/Disable CSM Support.

3.2.2.13 NVMe Configuration

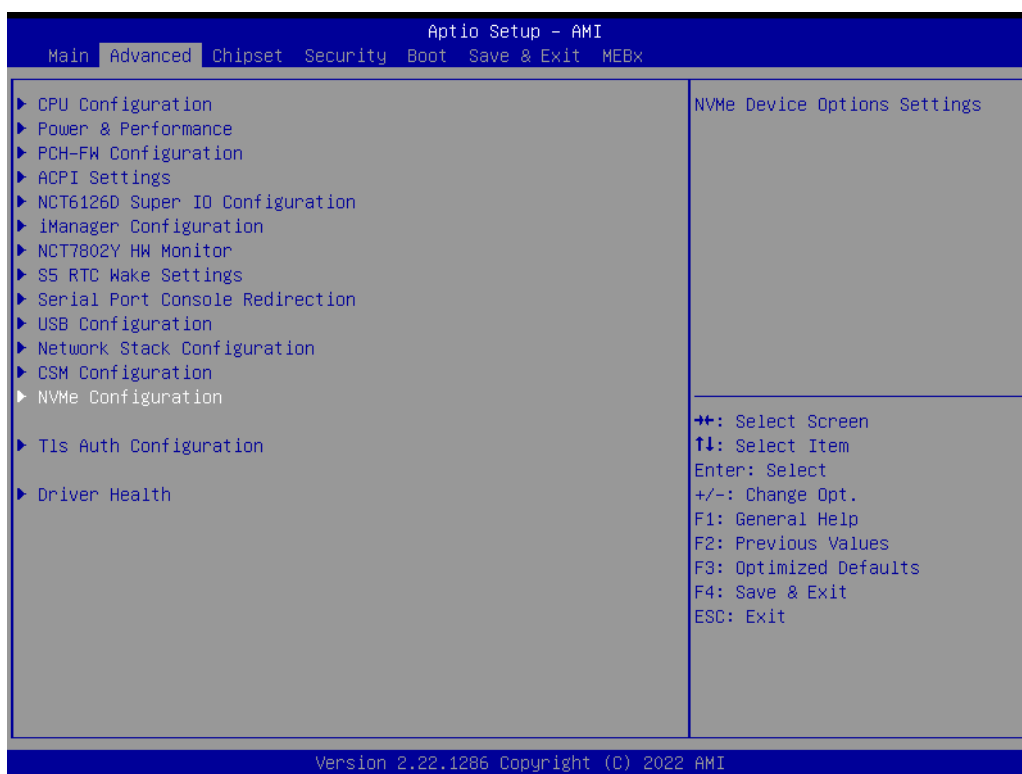

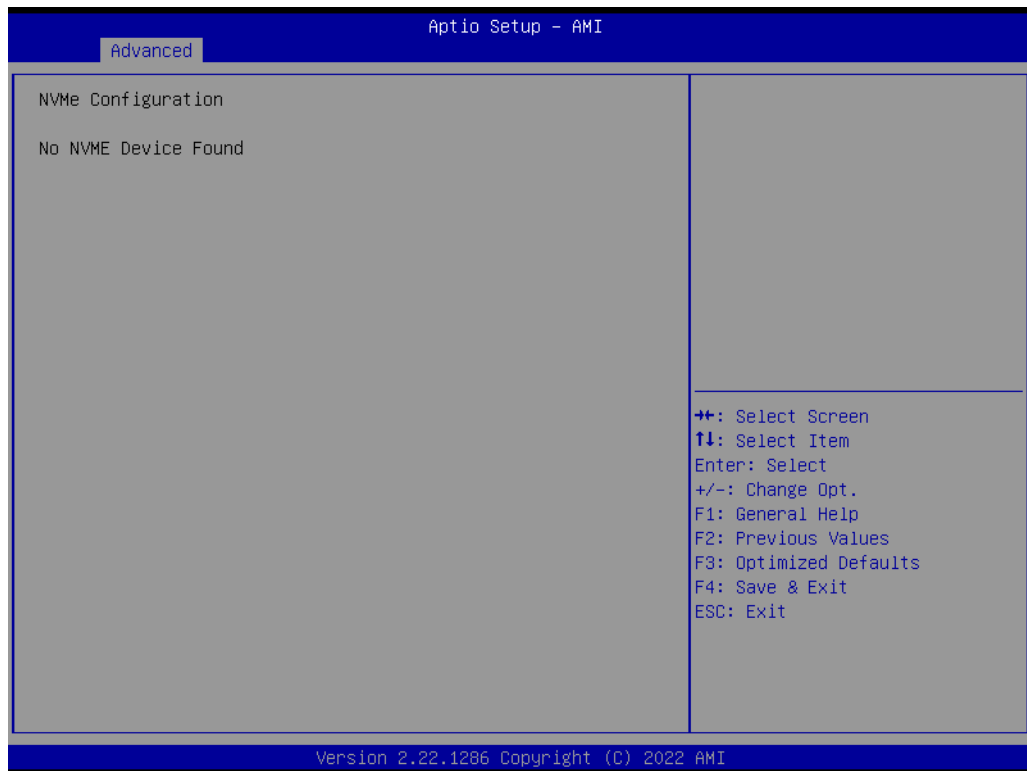

3.2.2.14 Tls Auth Configuration

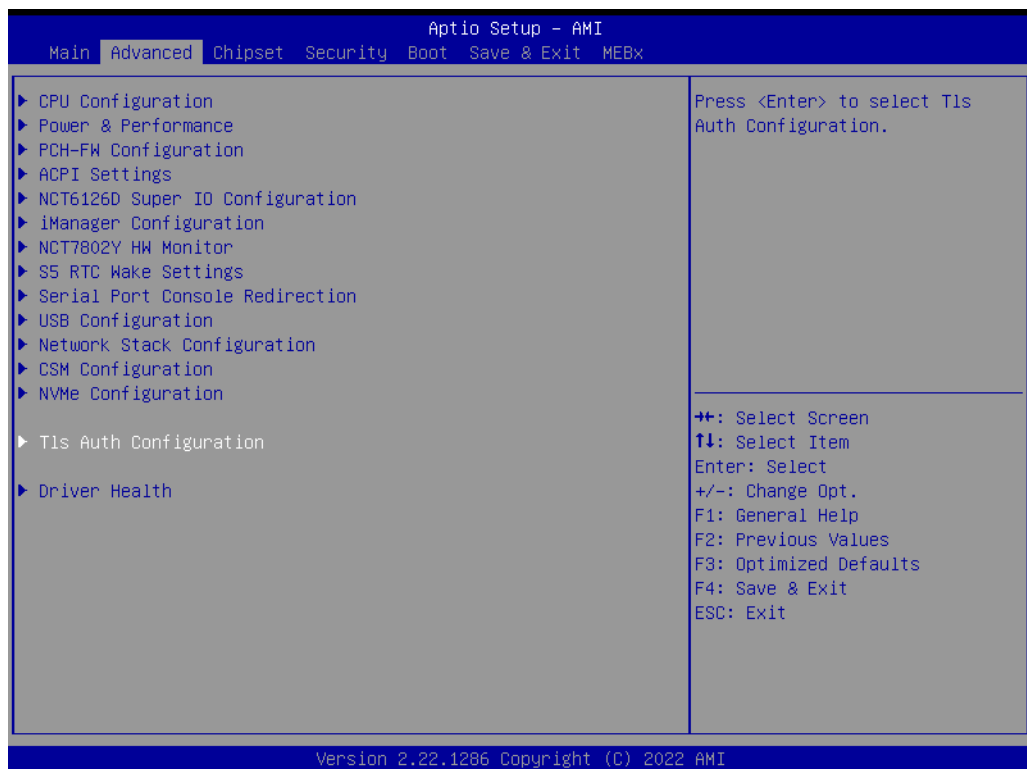



- **Server CA Configuration**
Press <Enter> to configure Server CA.
- **Client Cert Configuration**
Client cert configuration is unsupported currently.

3.2.2.15 Driver Health

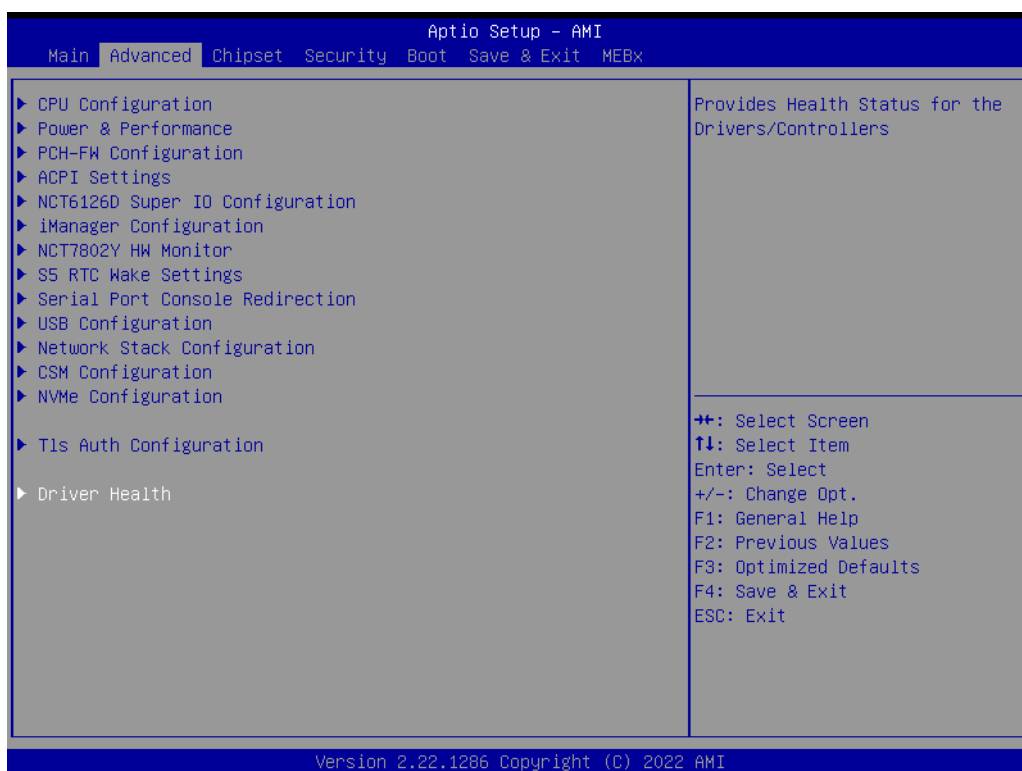

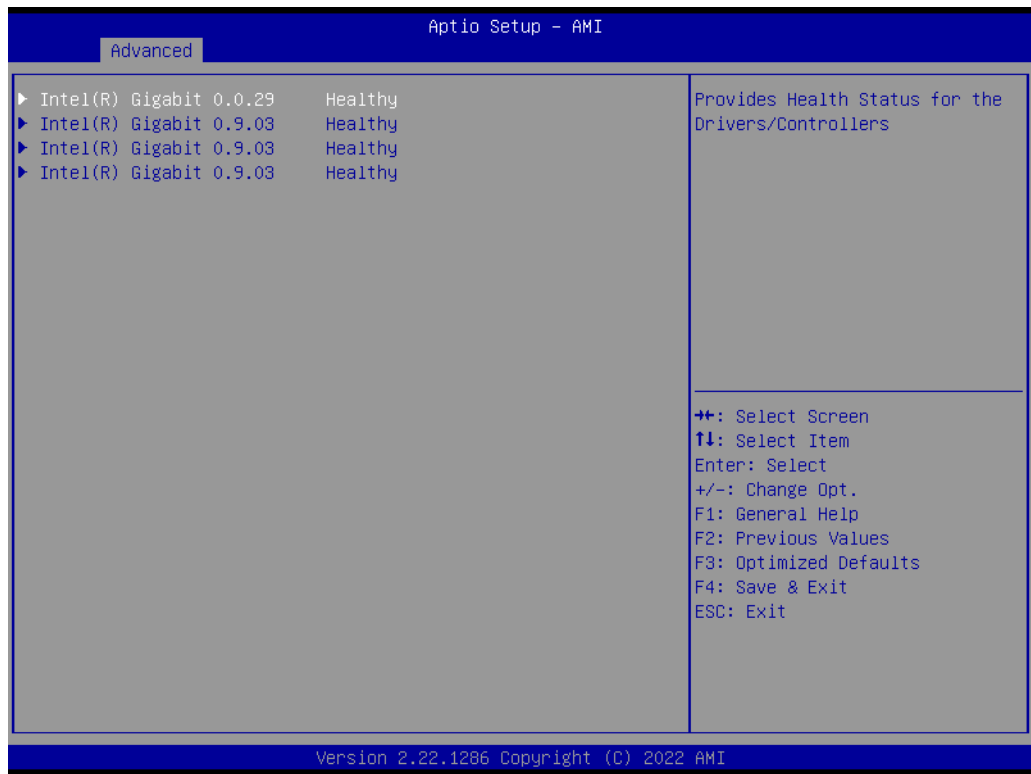

- Provides Health Status for the Drivers/Controllers

3.2.3 Chipset Configuration

Select the Chipset tab from the ARK-3534 setup screen to enter the Chipset BIOS Setup screen. You can display a Chipset BIOS Setup option by highlighting it using the <Arrow> keys. All Plug and Play BIOS Setup options are described in this section. The Plug and Play BIOS Setup screen is shown below.

3.2.3.1 System Agent Configuration

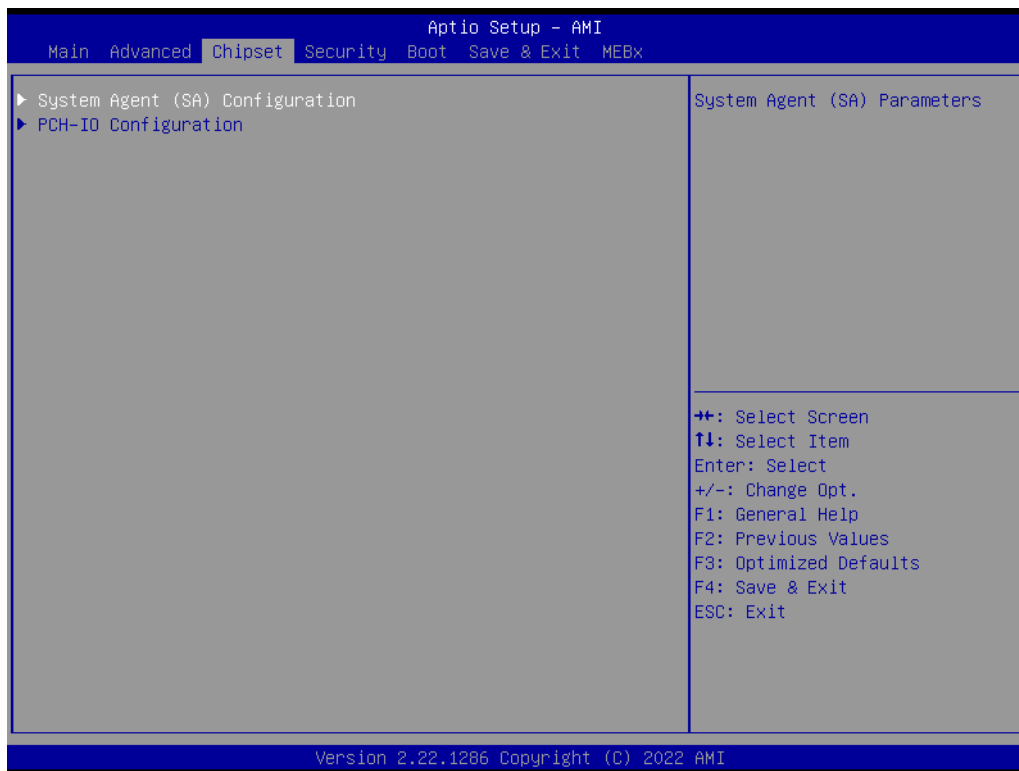

■ Memory Configuration Options

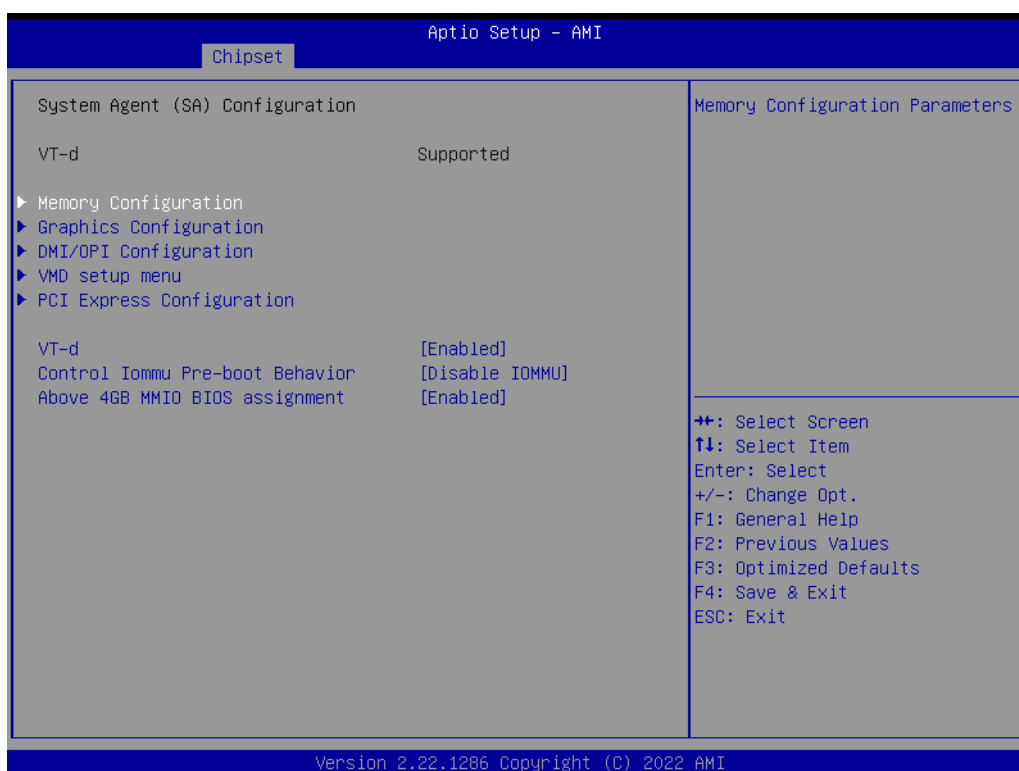

- VT-d
VT-d capability.
- Control Iommu Pre-boot Behavior
- Above 4GB MMIO BIOS assignment
Enable/Disable above 4GB Memory Mapped I/O BIOS assignment. This is enabled automatically when Aperture Size is set to 2048MB.

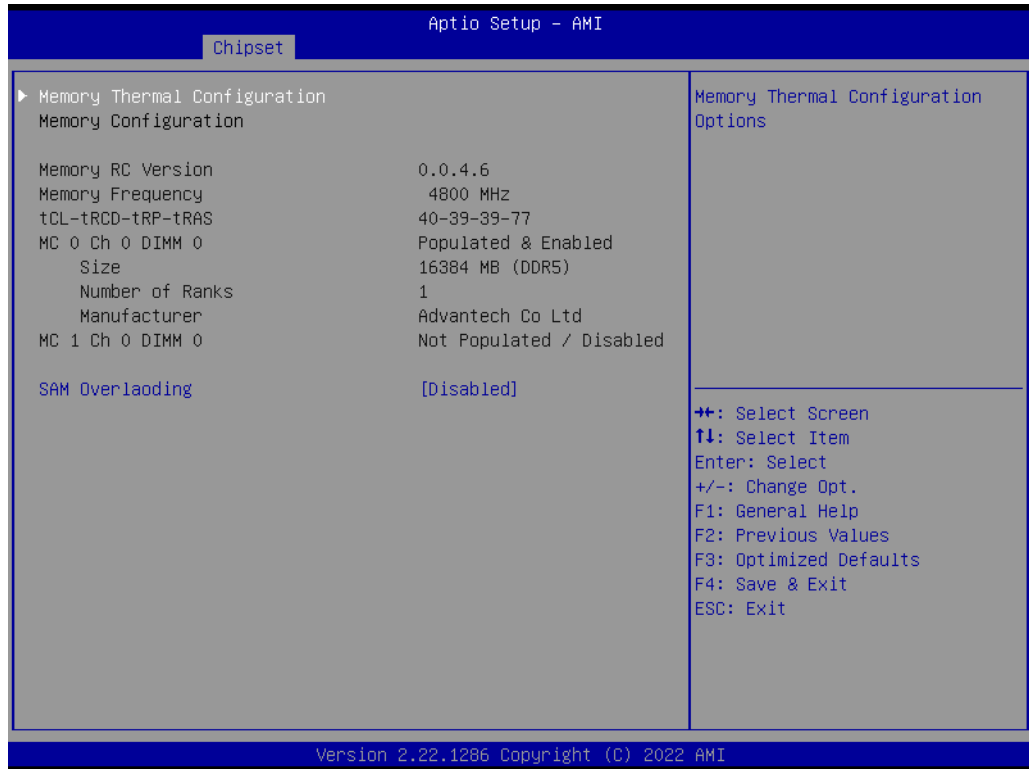

- SAM Overloading
Enable/Disable SAM Overloading.

■ Memory Thermal Configuration

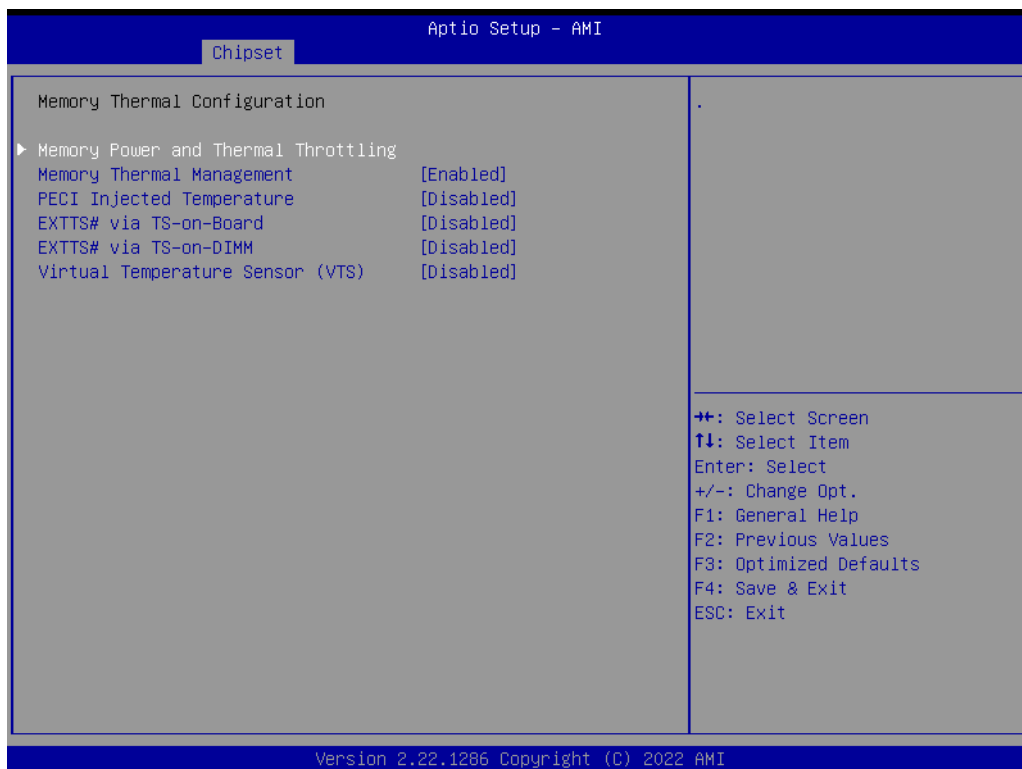

- Memory Thermal Management
Enable/Disable Memory Thermal Management.
- PECI Injected Temperature
Enable/Disable memory temperatures to be injected to the processor via PECI.
- EXTTS# via TS-on-Board
Enable/Disable routing TS-on-Board's ALERT# and THERM# to EXTTS# pins on the PCH.
- EXTTS# via TS-on-DIMM
Enable/Disable routing TS-on-DIMM's ALERT# to EXTTS# pin on the PCH.
- Virtual Temperature Sensor (VTS)
Enable/Disable Virtual Temperature Sensor (VTS).

■ Memory Power and Thermal Throttling

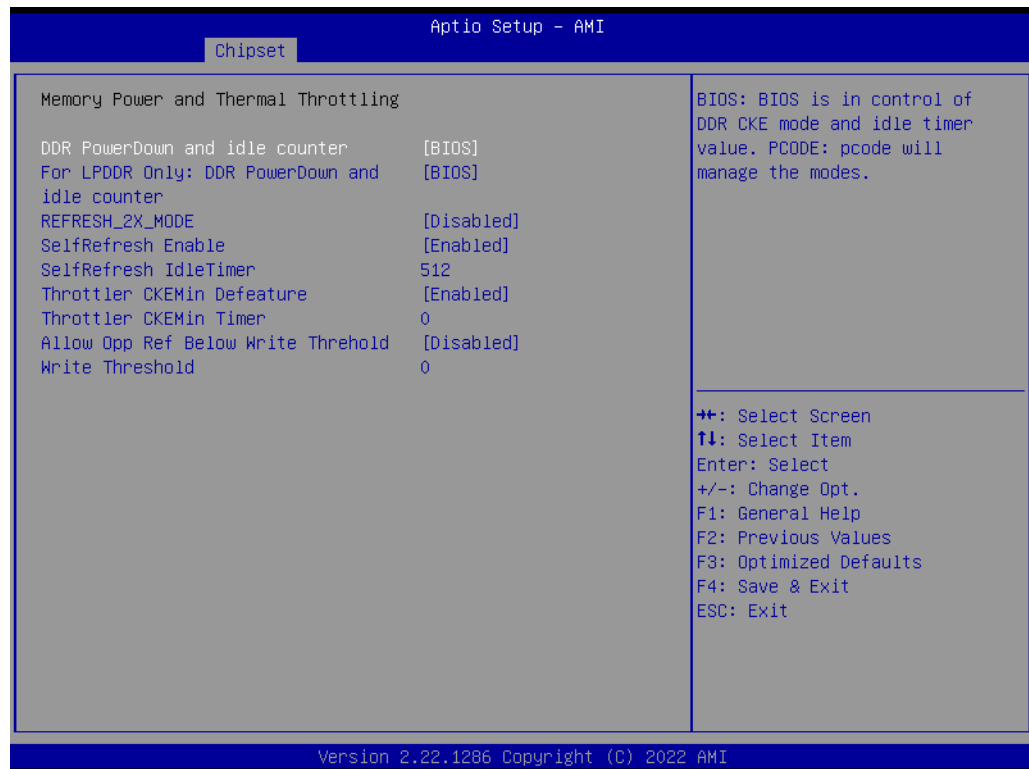

- DDR PowerDown and idle counter
BIOS: BIOS is in control of DDR CKE mode and idle timer value. PCODE: pcode will manage the modes.
- For LPDDR only: DDR PowerDown and idle counter
For LPDDR Only: BIOS: BIOS is in control of DDR CKE mode and idle timer value. PCODE: pcode will manage the modes.
- REFRESH_2X_MODE
0- Disabled 1-iMC enables 2xRef when Warm and Hot 2- iMC enables 2xRef when Hot.
- SelfRefresh Enable
Enable, Disable(Enable= Def)
- SelfRefresh IdleTimer
Range [64K-1;512]in DLCK800s, (512= Def)
- Throttler CKEMin Defeature
On, Off
- Throttler CKEMin Timer
Timer value for CKEMin, range[255;0]. Req'd min of SC_ROUND_T + BYTE_LENGTH (4)
- Allow Opp Ref Below Write Threshold
Allow opportunistic refreshes without exiting power down.
- Write Threshold
Number of writes that can be accumulated while CKE is low before CKE is asserted.

■ Graphics Configuration

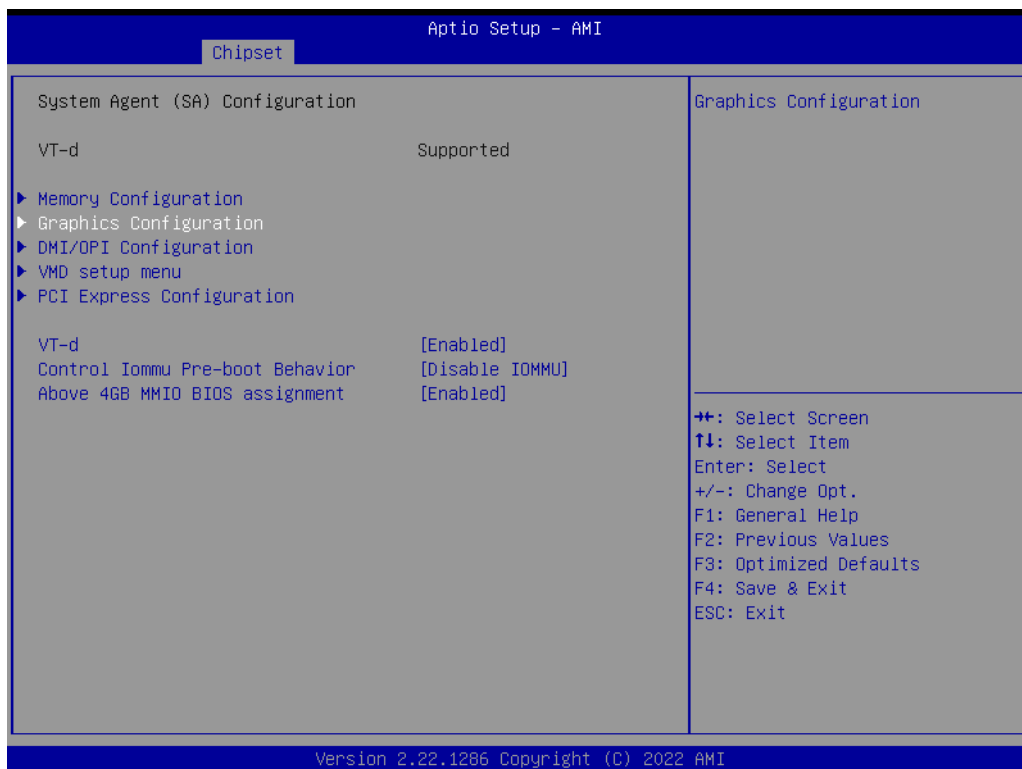

- Graphics Turbo IMON current
Graphics turbo IMON current values supported (14-31).
- Skip Scanning of External Gfx Card
If Enabled, it will not scan for External Gfx Card on PEG and PCH PCIE Ports.

-
- Primary Display
Select which (of IGFX/PEG/PCI) Graphics device should be the Primary Display or select SG for Switchable Gfx.
 - External Gfx Card Primary Display Configuration
Select the card used on the platform.
 - Internal Graphics
Keep IGFX enabled based on the setup options.
 - GTT Size
Select the GTT Size.
 - Aperture Size
Select the Aperture Size.
 - PSMI SUPPORT
PSMI Enable/Disable.
 - DVMT Pre-Allocated
Select DVMT 5.0 Pre-Allocated (Fixed) Graphics Memory size used by the Internal Graphics Device.
 - Intel Graphics PeI Display Peim
Enable/Disable Pei (Early) Display.
 - VDD Enable
Enable/Disable forcing of VDD in the BIOS.
 - Configure GT for use
Enable/Disable GT configuration in BIOS.
 - RC1p Support
Enable/Disable RC1p support. If RC1p is enabled, send a RC1p frequency request to PMA based other conditions being met.
 - PAVP Enable
Enable/Disable PAVP
 - Cdynmax Clamping Enable
Enable/Disable Cdynmax Clamping
 - Cd Clock Frequency
Select the highest Cd Clock frequency supported by the platform.

■ DMI/OPI Configuration

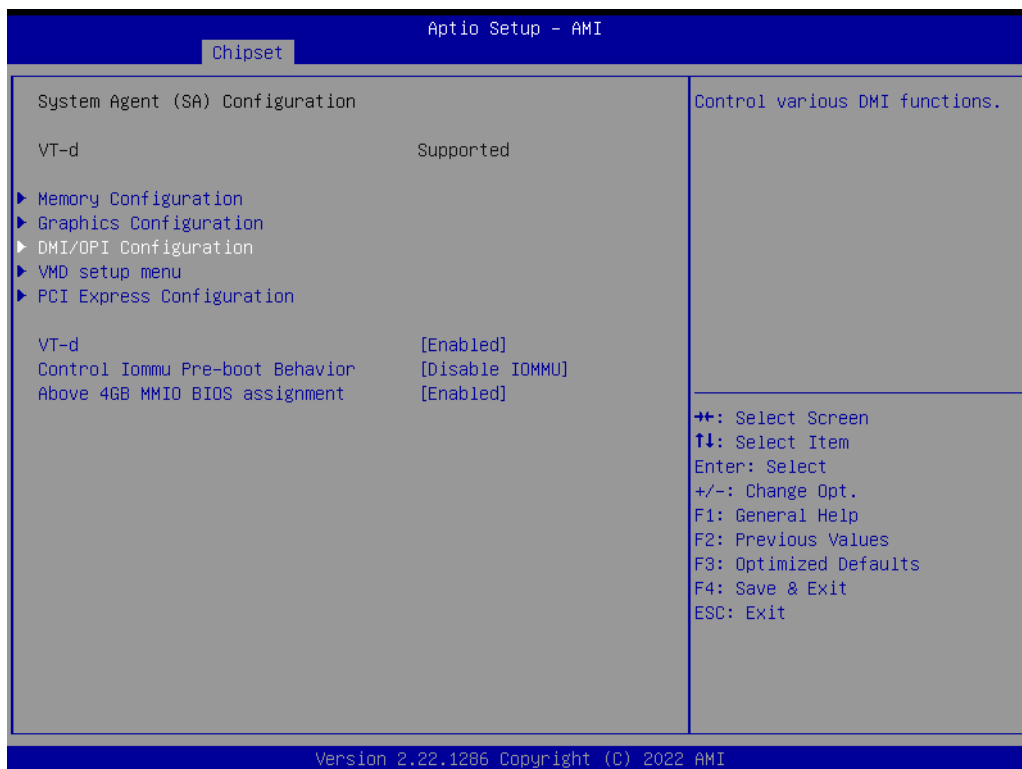

- DMI Max Link Speed
Set DMI Speed Gen1/Gen2/Gen3.
- CDR Relock for CPU DMI
Enable/Disable CDR Relock.

- DMI ASPM
 - DMI ASPM Support
- DMI Gen3 L1 Latency
 - DMI Gen3 L1 Exit Latency.
- New FOM for CPU DMI
 - Enable/Disable New FOM.

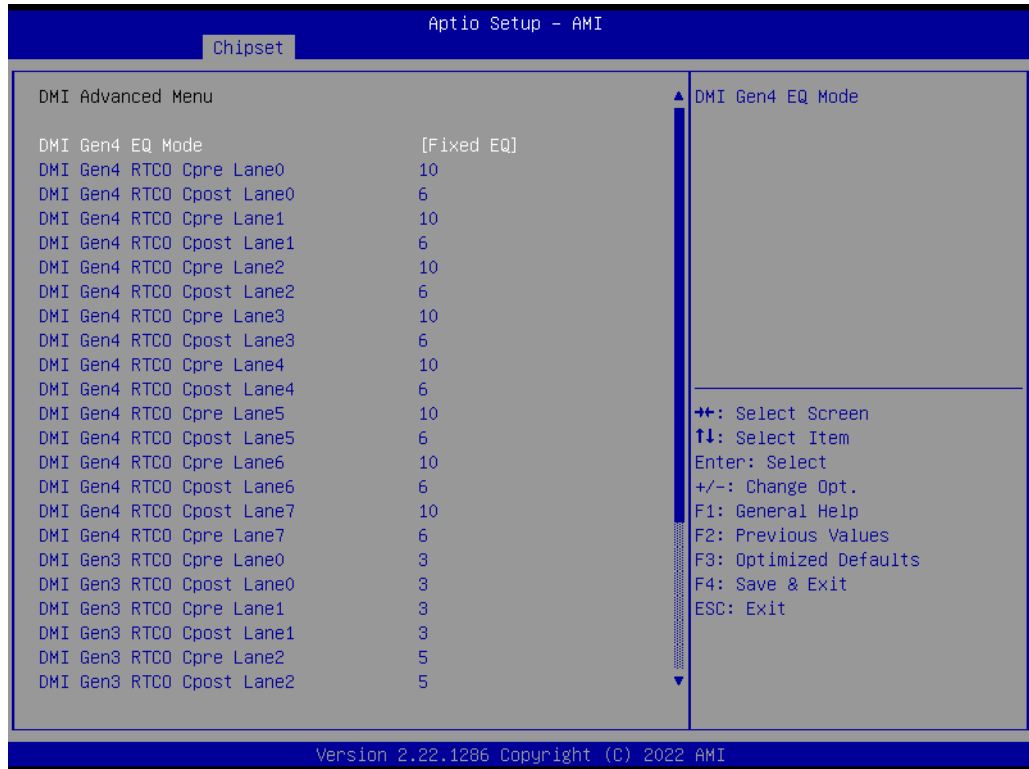

■ VMD Setup Menu

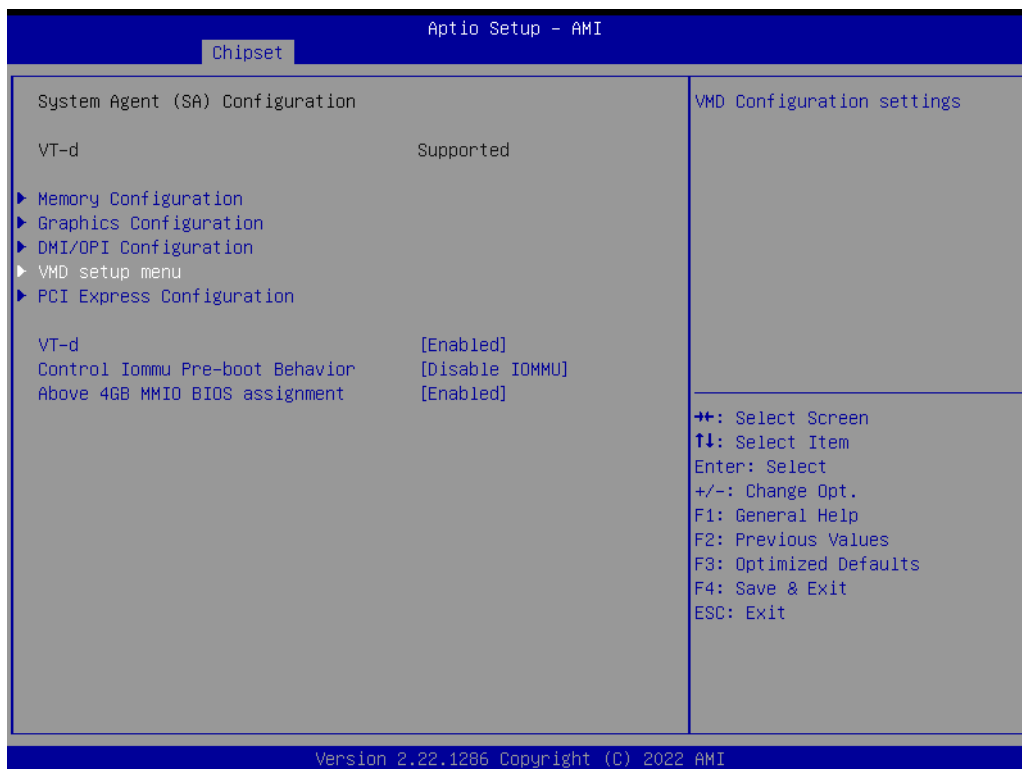

- Enable VMD Controller
Enable/Disable to VMD controller.

■ **MXM 3.1 (3D) Controller**

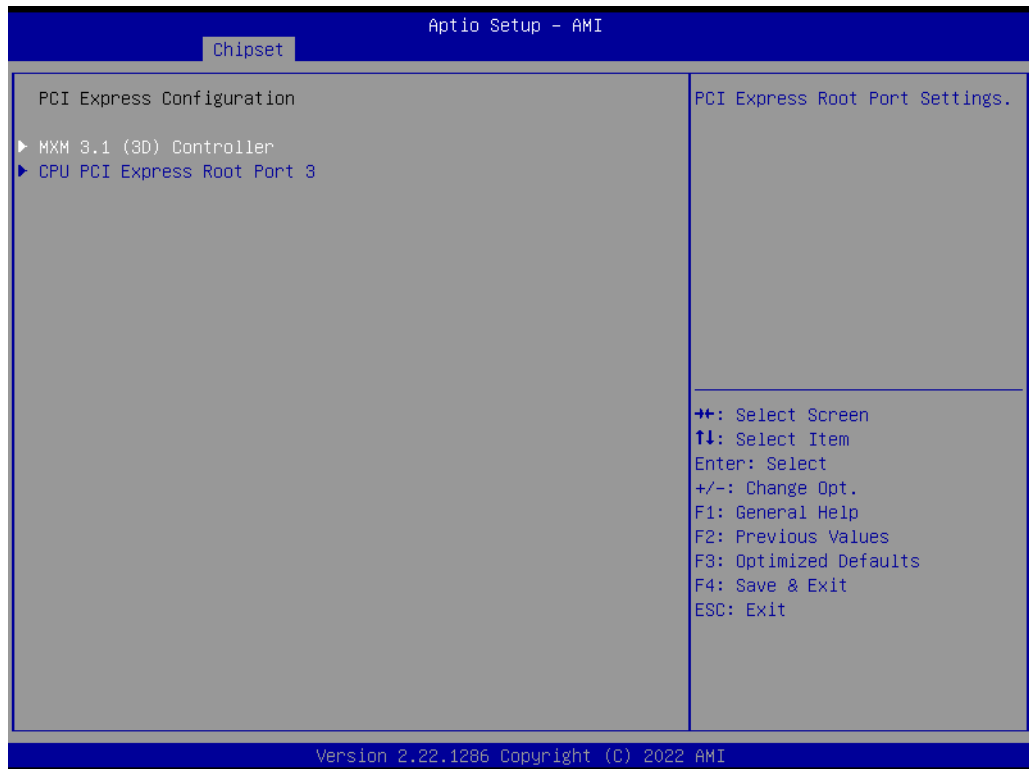
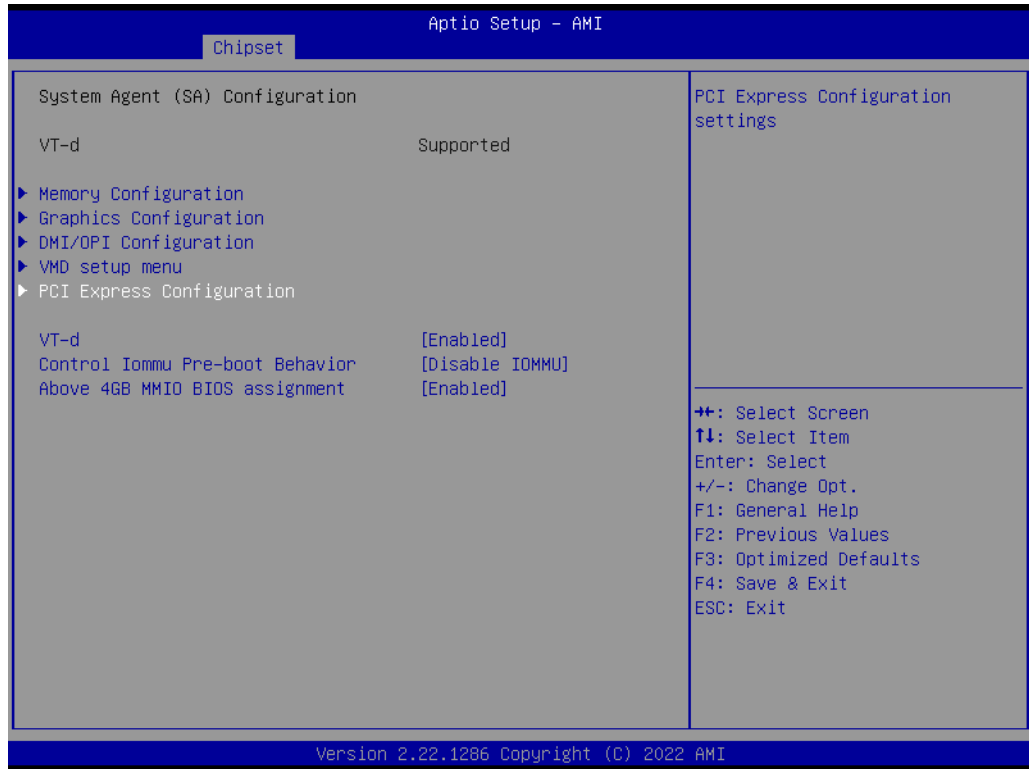



- PCI Express Clock Gating
PCI Express Clock Gating Enable/Disable for each root port.
- PCI Express Power Gating
PCI Express Power Gating Enable/Disable for each root port.
- ASPM
PCI Express Active State Power Management settings.
- L1 Substates
PCI Express L1 Substates settings.L1SS cannot be enabled when CLKREQMSG is disabled.
- Gen3 EQ Phase3 Method
PCIe Gen3 Equalization Phase 3 Method.
- Gen4 EQ Phase3 Method
PCIe Gen4 Equalization Phase 3 Method.
- ACS
Enable/Disable Access Control Services Extended Capability.
- PTM
Enable/Disable Precision Time Measurement.
- DPC
Enable/Disable Downstream Port Containment.
- FOM Scoreboard Control Policy
Select the FOM Scoreboard Control Policy, when set to Auto, speed is based on TLS.
- Multi-VC
Enable/Disable Multi Virtual Channel.
- EDPC
Enable/Disable Rootport extensions for Downstream Port Containment.
- URR
PCI Express Unsupported Request Reporting Enable/Disable.

- FER
PCI Express Device Fatal Error Reporting Enable/Disable.
- NFER
PCI Express Device Non-Fatal Error Reporting Enable/Disable.
- CER
PCI Express Device Correctable Error Reporting Enable/Disable.
- CTO
PCI Express Device Correctable Error Reporting Enable/Disable.
- SEFE
Root PCI Express System Error on Fatal Error Enable/Disable.
- SENFE
Root PCI Express System Error on Non-Fatal Error Enable/Disable.
- SECE
Root PCI Express System Error on Correctable Error Enable/Disable.
- PME SCI
PCI Express PME SCI Enable/Disable.
- Advanced Error Reporting
Advanced Error Reporting Enable/Disable.
- Cle Speed
Configure PCIe Speed
- Enable ClockReq Messaging
Enable or Disable ClockReq Messaging.



- Transmitter Half Swing
Transmitter Half Swing Enable/Disable.
- P2P Support
Program P2P Support Registers according to setup option.
- CPU PCIe Func0 Link Disable
CPU PCIe Func0 Link Disable while Device attached into Port having Func0 and FuncN.

- LTR
SA PCIE Latency Reporting Enable/Disable.
- Snoop Latency Override
Snoop Latency Override for SA PCIE.
- Non Snoop Latency Override
Non Snoop Latency Override for SA PCIE.
- Force LTR Override
Force LTR Override for SA PCIE.
- LTR Lock
PCIE LTR Configuration Lock.
- UPTP
Upstream Port Transmitter Preset.
- DPTP
Downstream Port Transmitter Preset.

■ CPU PCI Express Root Port 3



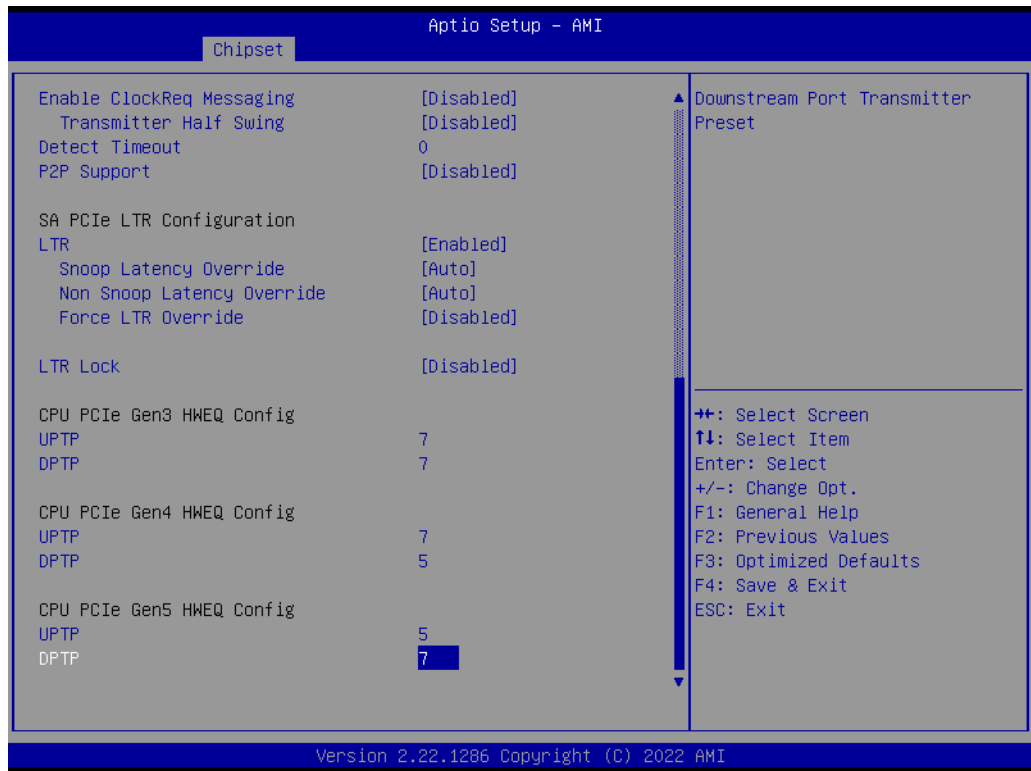
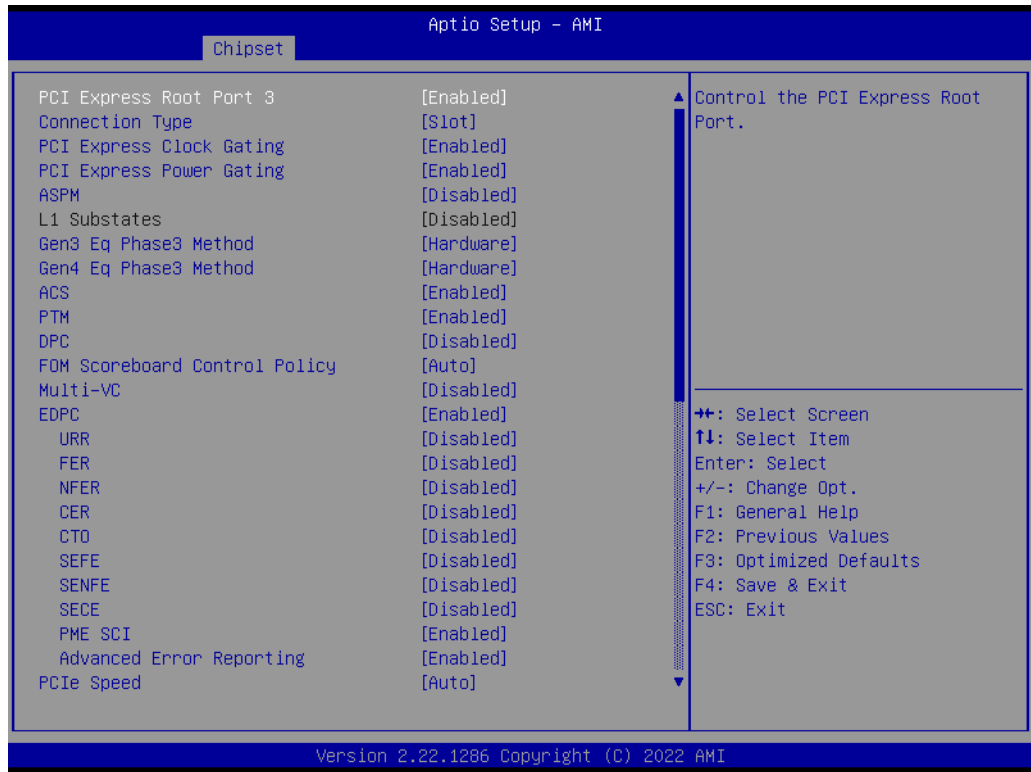

- PCH-PCI Express Root Port 3
Control the PCI Express Root Port.

3.2.3.2 PCH-IO Configuration

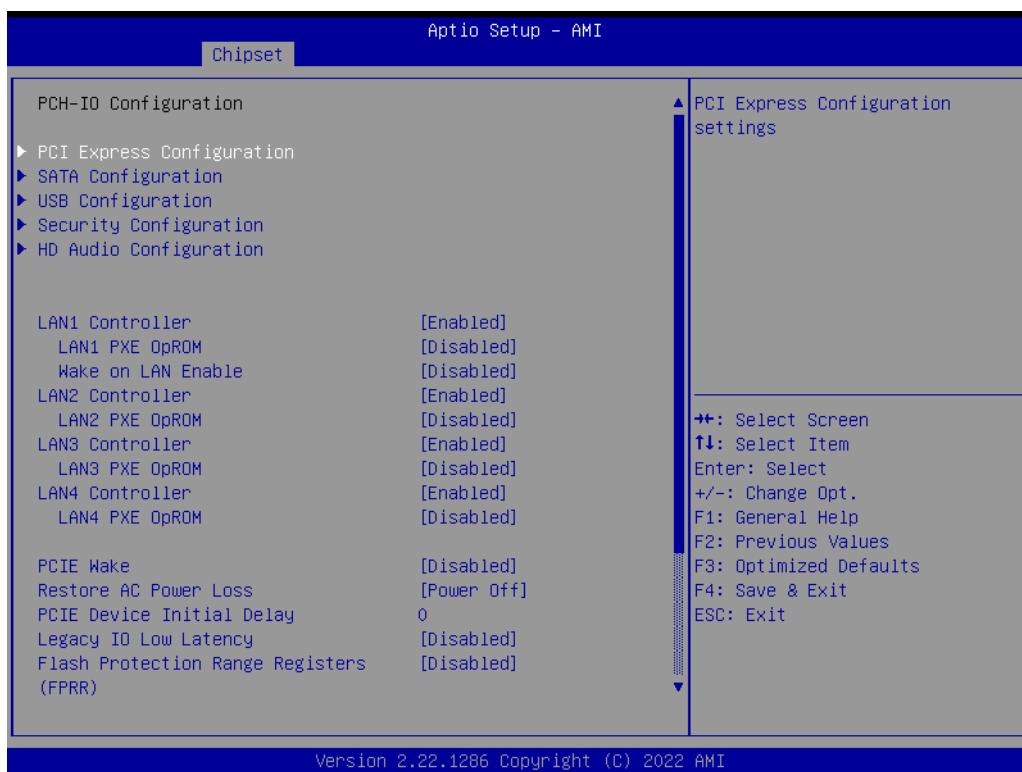

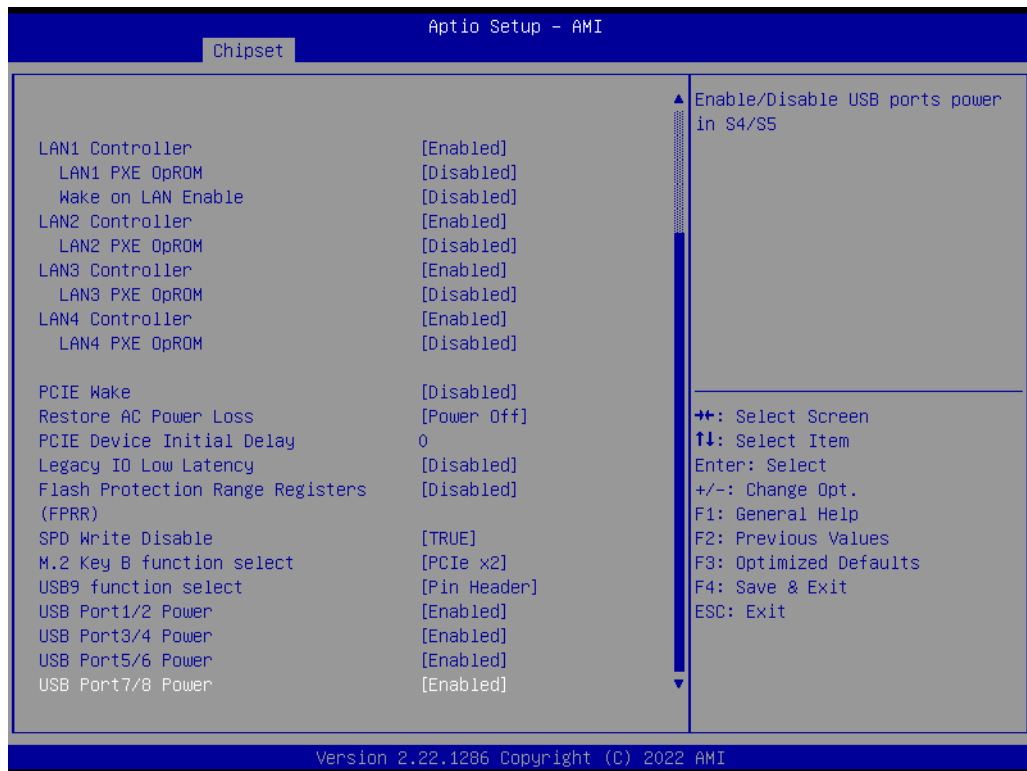

- **LAN1~4 Controller**
Enable/Disable onboard NIC.
- **LAN1~4 PXE OpROM**
Enable or disable boot option for LAN1 Controller.
- **Wake on LAN Enable**
Enable/Disable integrated LAN to wake the system.
- **PCIE Wake**
Enable or disable PCIE to wake the system from S5.
- **Restore AC Power Loss**
Specify what state to go to when power is re-applied after a power failure (G3 state).
- **PCIE Device Initial Delay**
The PCIE device initial delay 0~30 seconds.
- **Legacy IO Low Latency**
Set to enable low latency of legacy IO. Some systems require lower IO latency irrespective of power. This is a tradeoff between power and IO latency.
- **Flash Protection Range Registers (FPRR)**
Enable Flash Protection Range Registers.
- **SPD Write Disable**
Enable/Disable setting SPD Write Disable. For security recommendations, SPD write disable bit must be set.
- **M.2 Key B Function Select**
M.2 B-Key function select.
- **USB Port Power**
Enable/Disable USB port power in S4/S5.

■ PCI Express Configuration

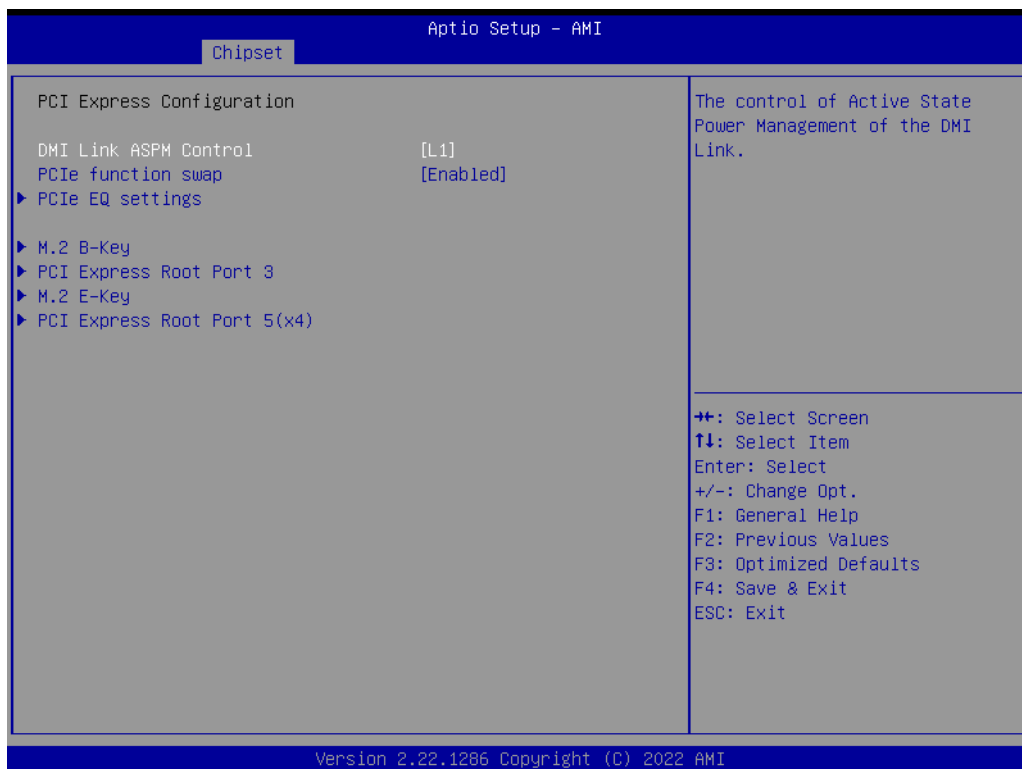

- DMI Link ASPM Control
The control of Active State Power Management of the DMI Link.
- PCIe function swap
Enable/Disable PCIe function swap.



- PCIe EQ override
Choose your own PCIe EQ settings, only for users who have a thorough understanding of equalization process.

■ **M.2 B-Key**

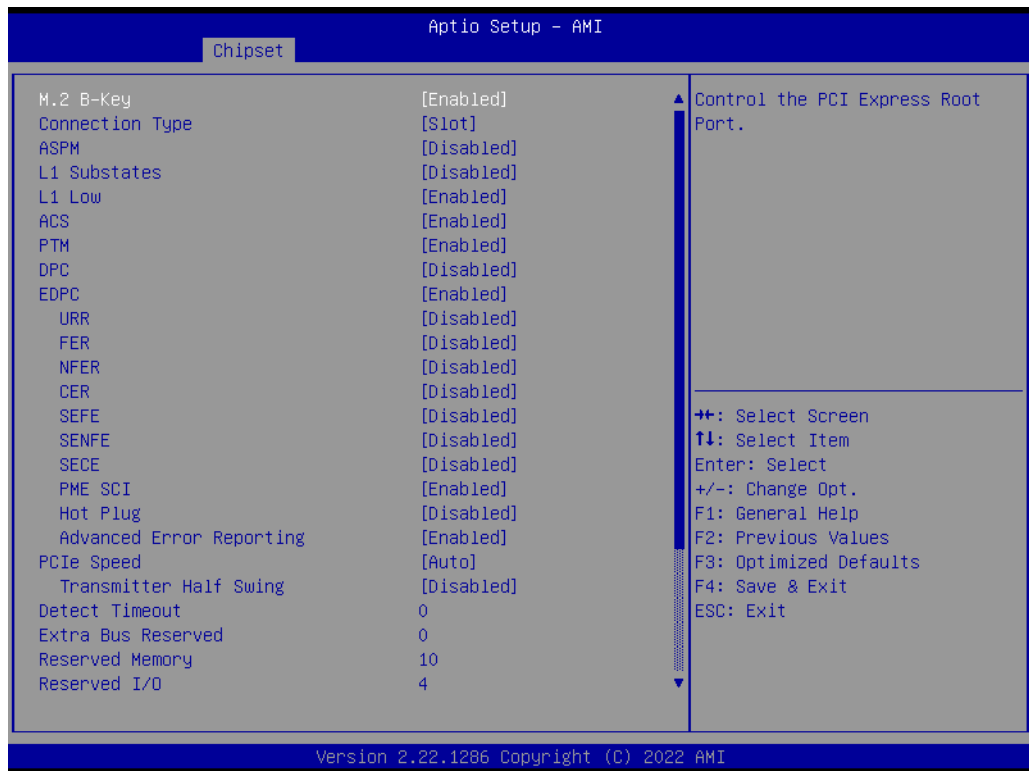
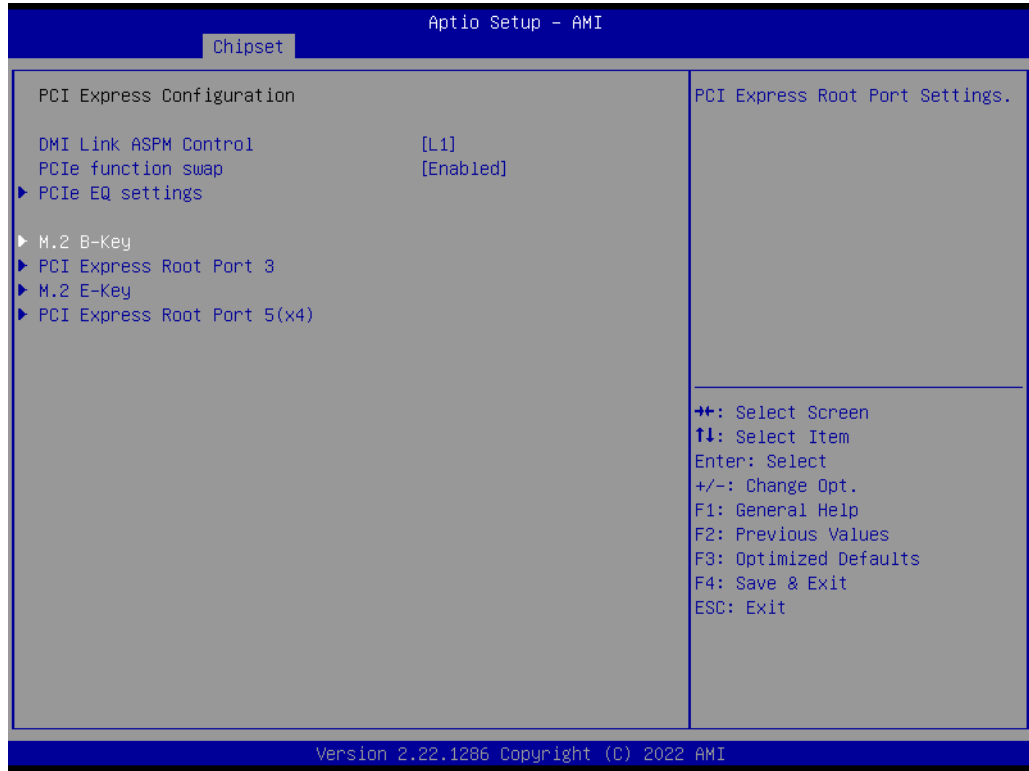

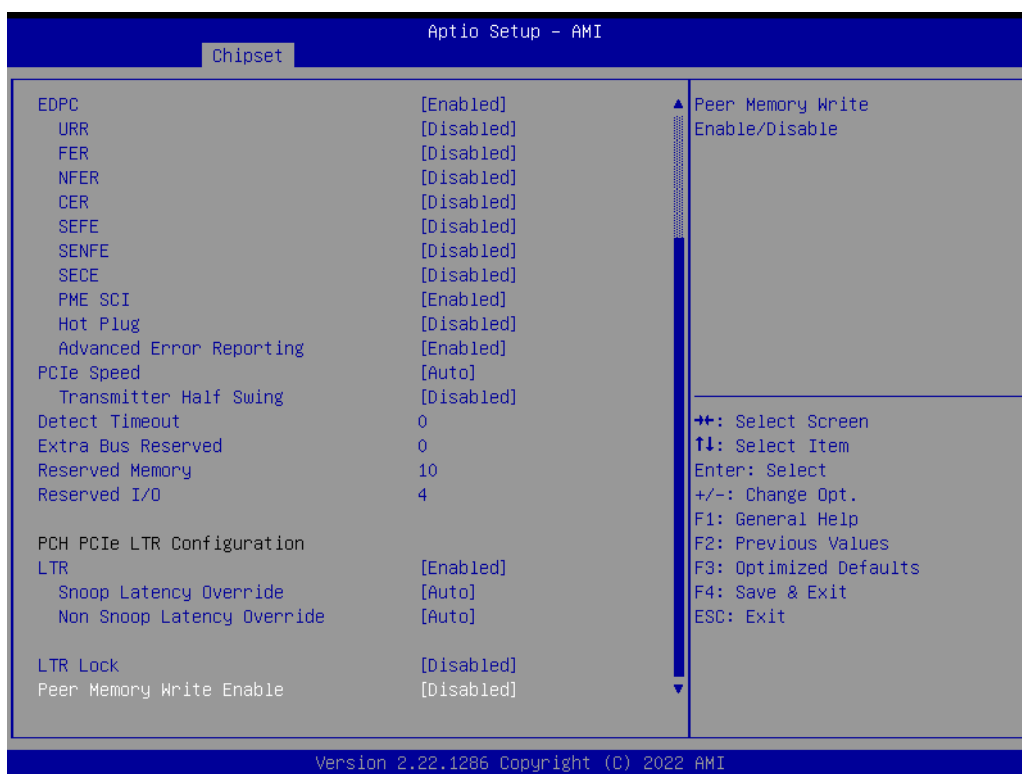

- ASPM
PCI Express Active State Power Management settings.
- L1 Substates
PCI Express L1 Substates settings.L1SS cannot be enabled when CLKREQMSG is disabled.
- L1 Low
PCI Express L1 Low Substate Enable/Disable.
- ACS
Enable/Disable Access Control Services Extended Capability.
- PTM
Enable/Disable Precision Time Measurement.
- DPC
Enable/Disable Downstream Port Containment.
- EDPC
Enable/Disable Rootport extensions for Downstream Port Containment.
- URR
PCI Express Unsupported Request Reporting Enable/Disable.
- FER
PCI Express Device Fatal Error Reporting Enable/Disable.
- NFER
PCI Express Device Non-Fatal Error Reporting Enable/Disable.
- CER
PCI Express Device Correctable Error Reporting Enable/Disable.
- SEFE
Root PCI Express System Error on Fatal Error Enable/Disable.
- SENFE
Root PCI Express System Error on Non-Fatal Error Enable/Disable.
- SECE
Root PCI Express System Error on Correctable Error Enable/Disable.

- PME SCI
PCI Express PME SCI Enable/Disable.
- Hot Plug
PCI Express Hot Plug Enable/Disable.
- Advanced Error Reporting
Advanced Error Reporting Enable/Disable.
- PCIe Speed
Configure PCIe Speed
- Transmitter Half Swing
Transmitter Half Swing Enable/Disable.
- LTR
SA PCIE Latency Reporting Enable/Disable.
- Snoop Latency Override
Snoop Latency Override for SA PCIE.
- Non Snoop Latency Override
Non Snoop Latency Override for SA PCIE.
- LTR Lock
PCIE LTR Configuration Lock
- Peer Memory Write Enable.
Peer Memory Write Enable/Disable.

■ **PCI Express Root Port 3**

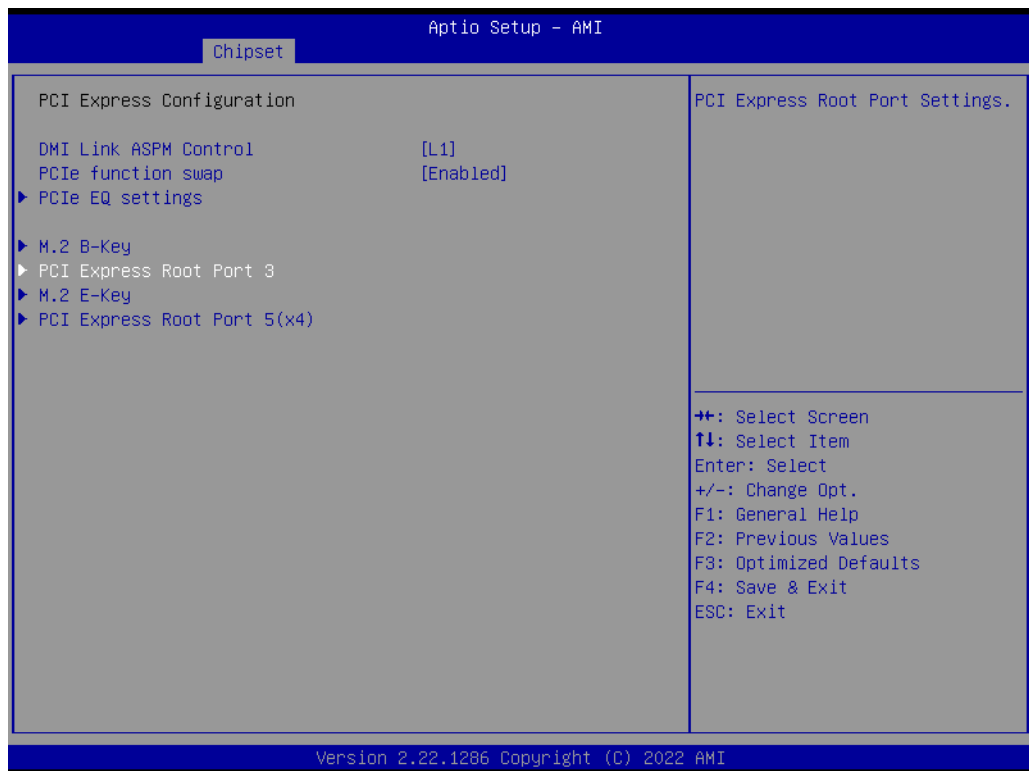

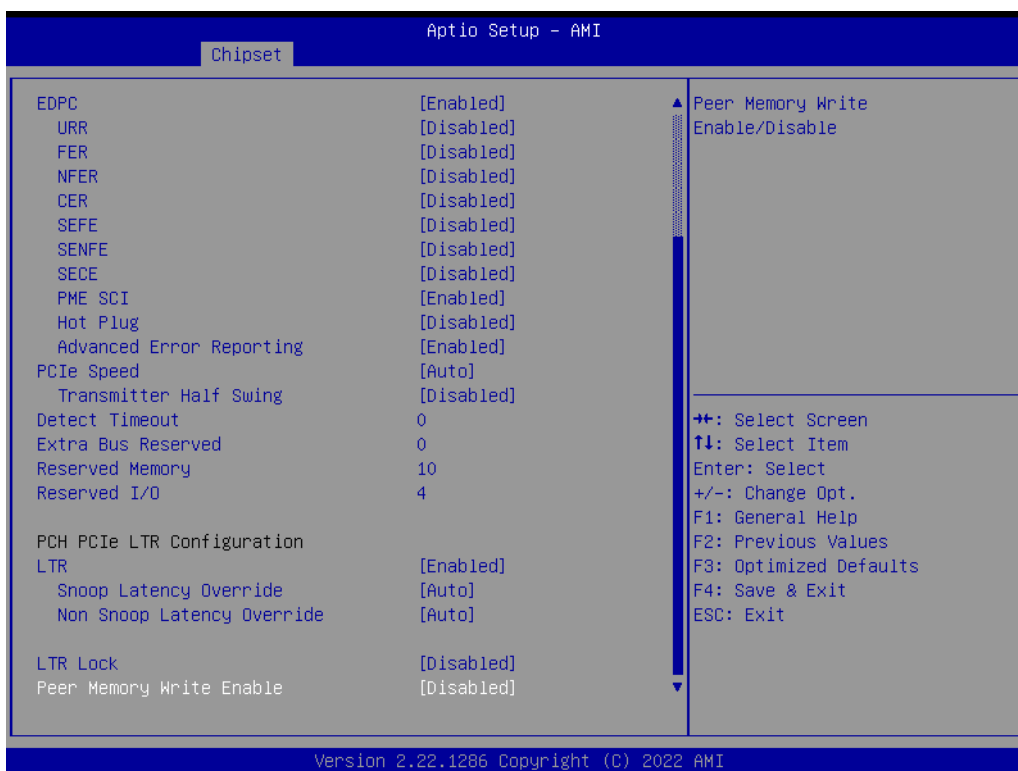
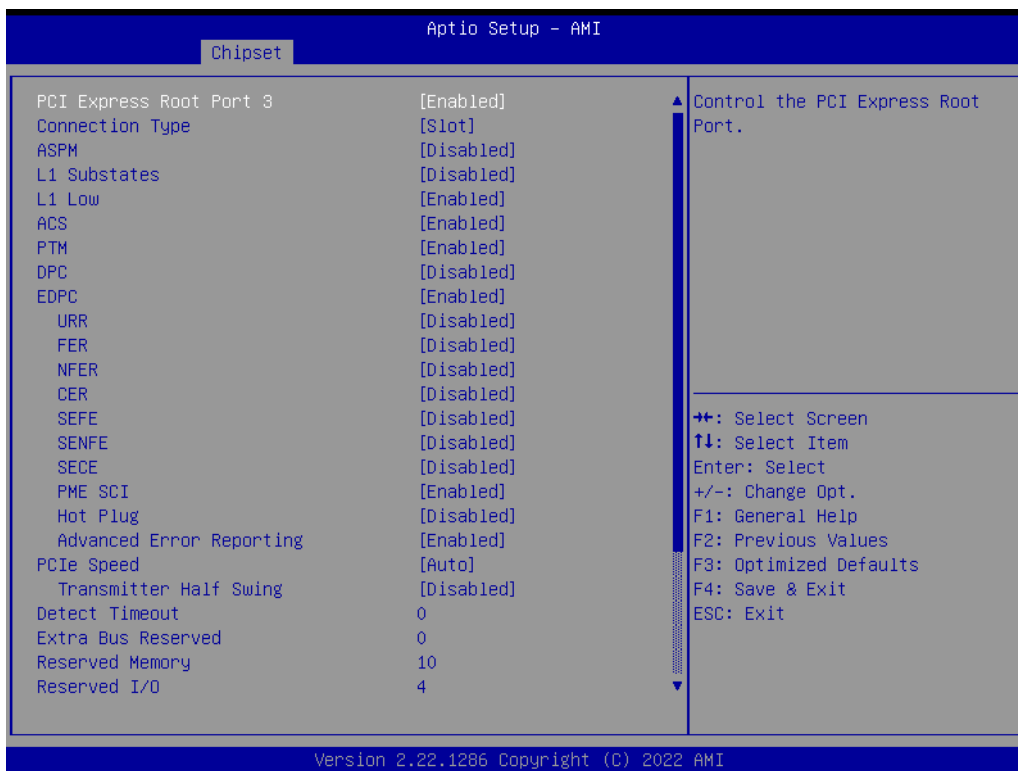

■ **M.2 E-Key**

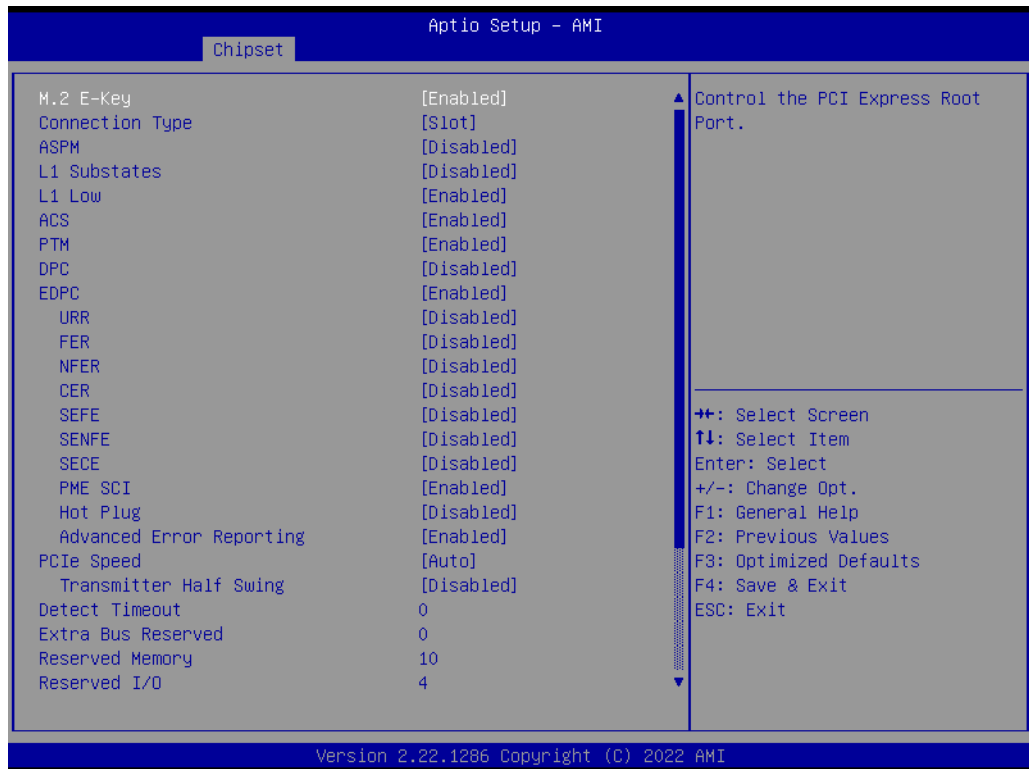
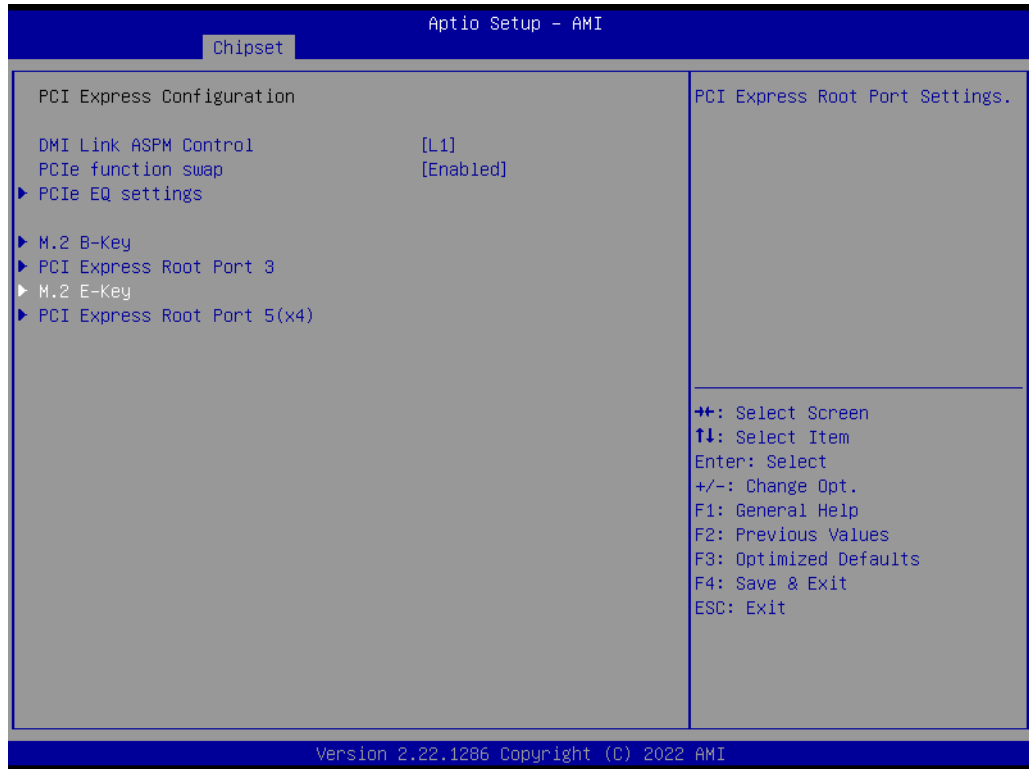

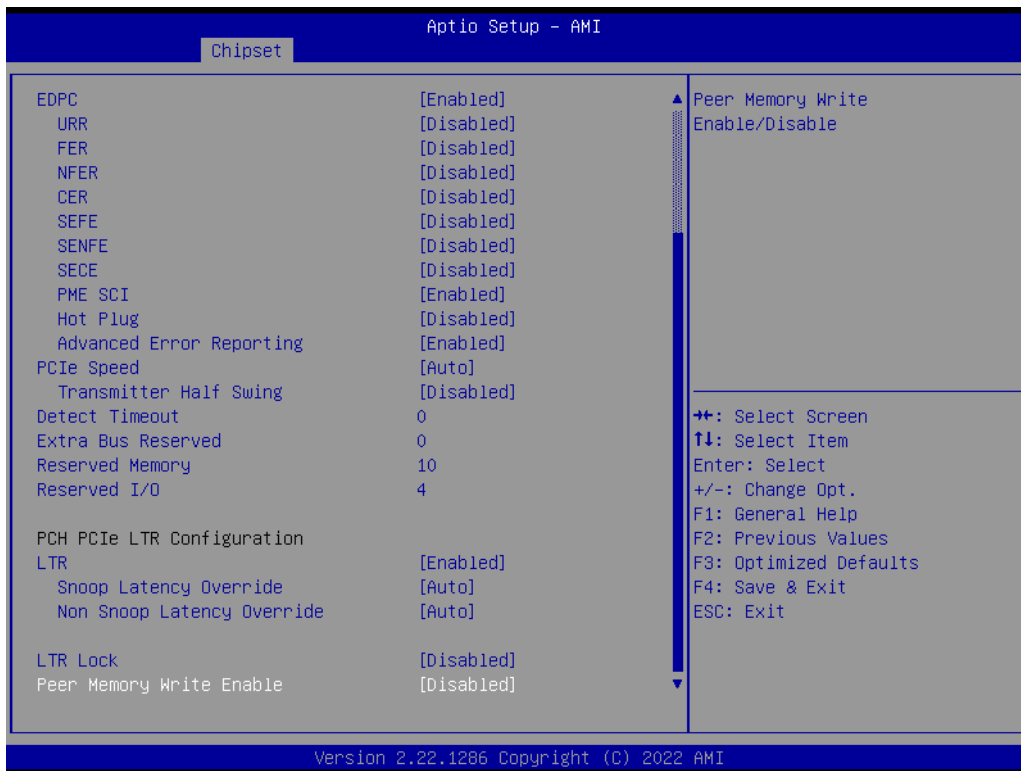

■ **PCI Express Root Port 5(x4)**

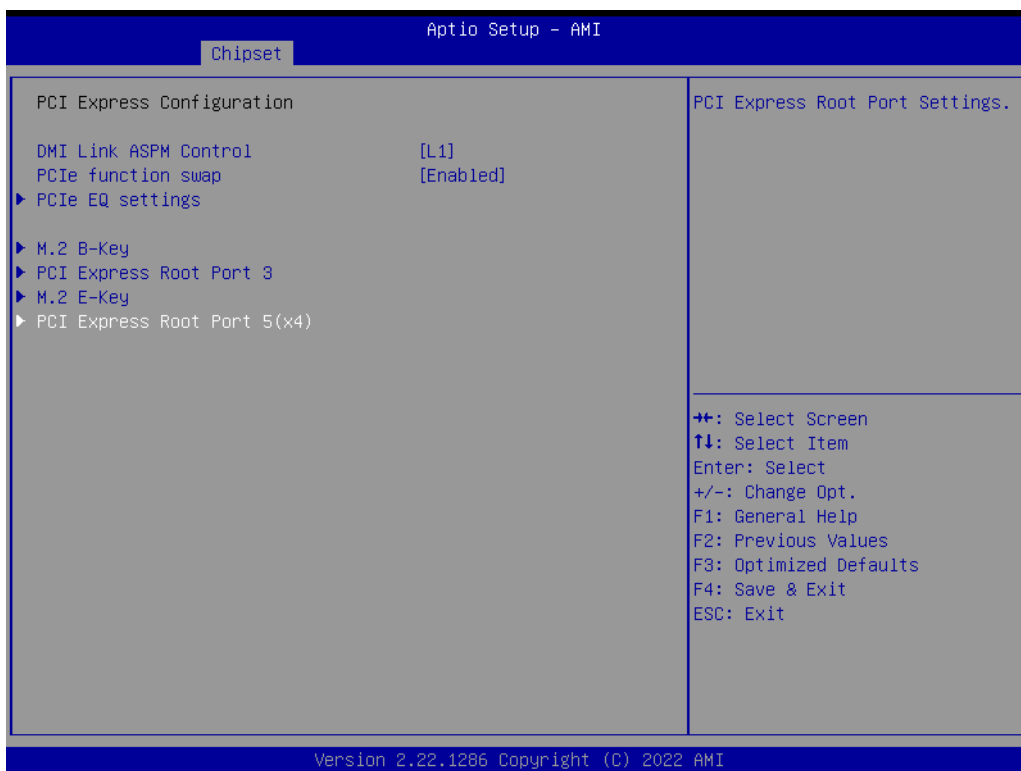

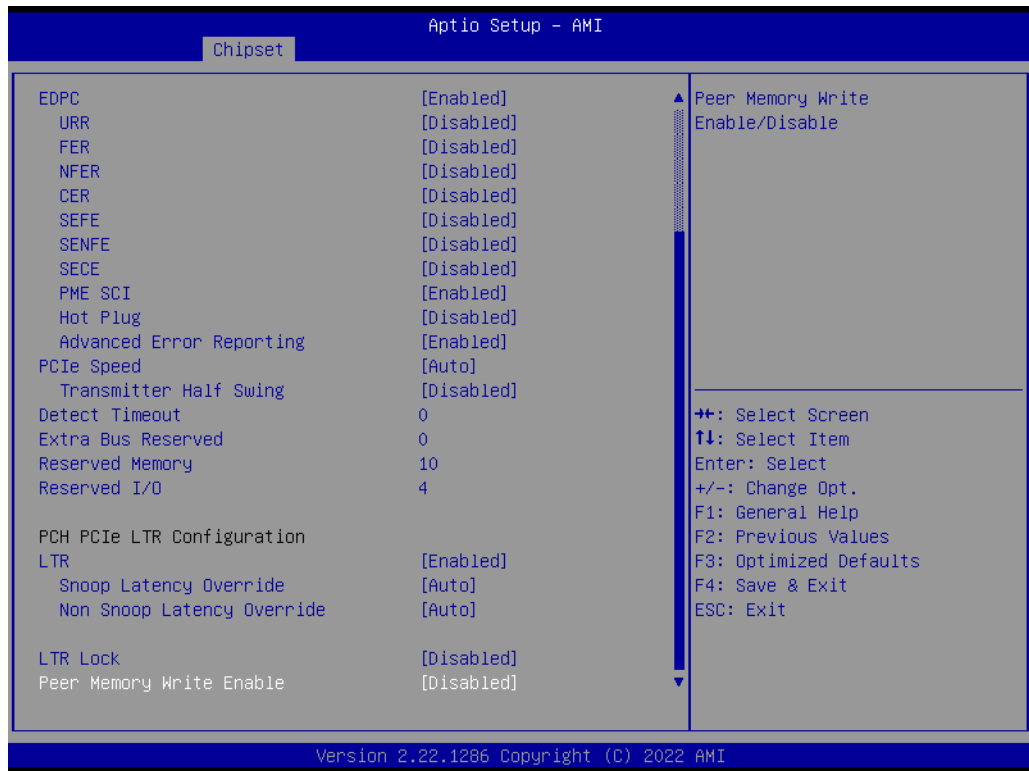
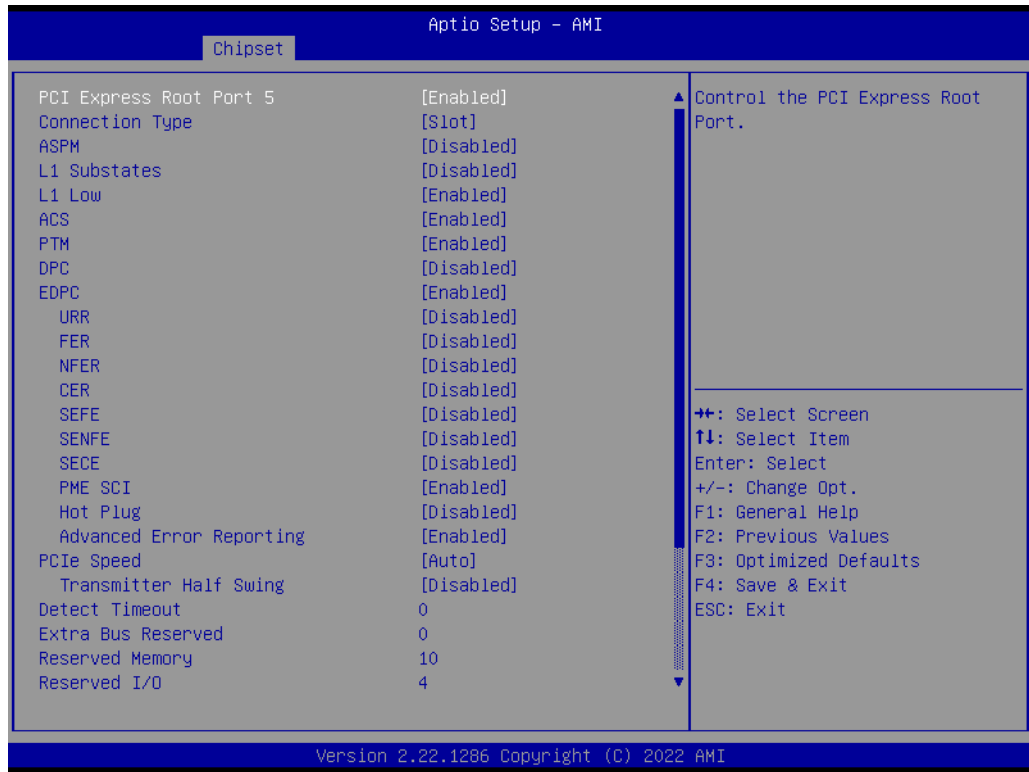

■ **SATA Configuration**

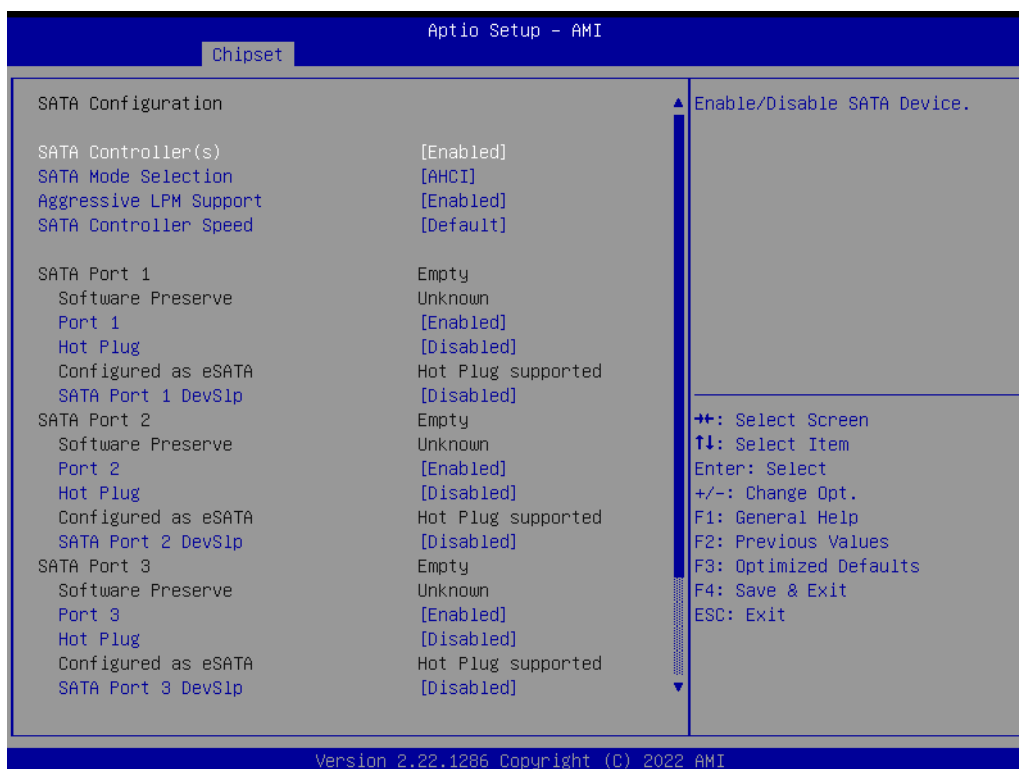
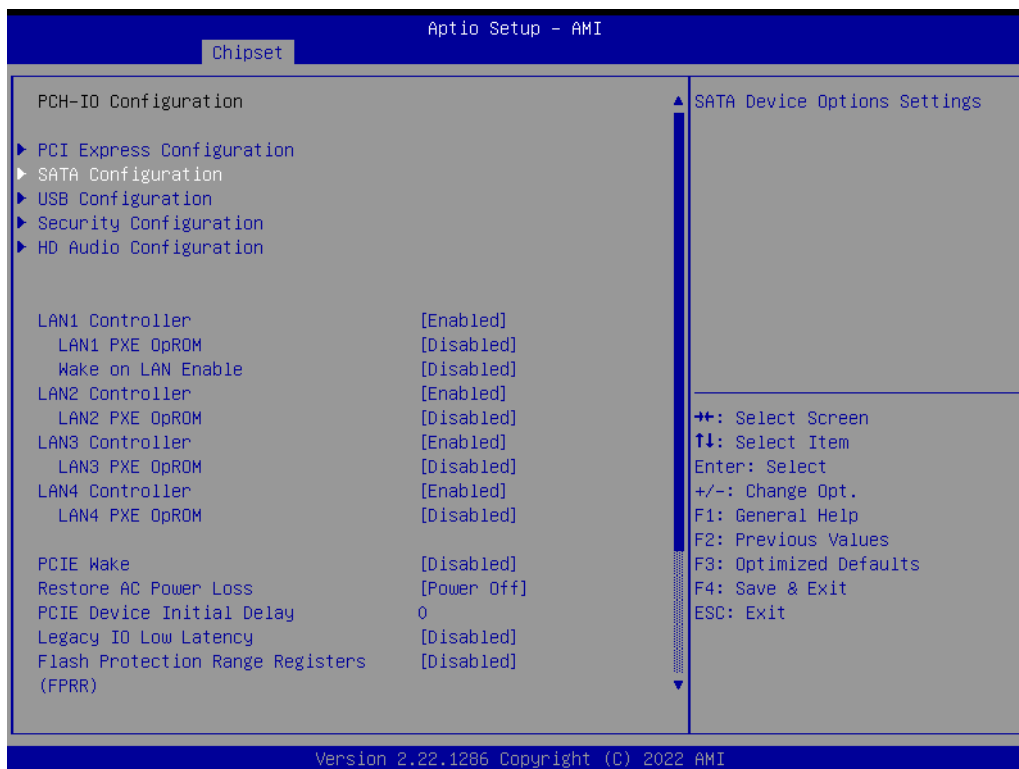



- SATA Controller(s)
Enable/Disable SATA Device.
- SATA Mode Selection
Determines how SATA controller(s) operate.
- Aggressive LPM Support
Enable PCH to aggressively enter link power state.
- SATA Controller Speed-
Indicates the maximum speed the SATA controller can support.
- Port 1~4/mSATA
Enable or Disable SATA/mSATA Port.
- Hot Plug
SATA Hot Plug Enable/Disable.
- SATA Port 1 DevSlp
Enable/Disable SATA Port 1 DevSlp. For DevSlp to work, both hard drive and SATA ports need to support the DevSlp function, otherwise an unexpected behavior might occur. Please check the board design before enabling it.

■ USB Configuration

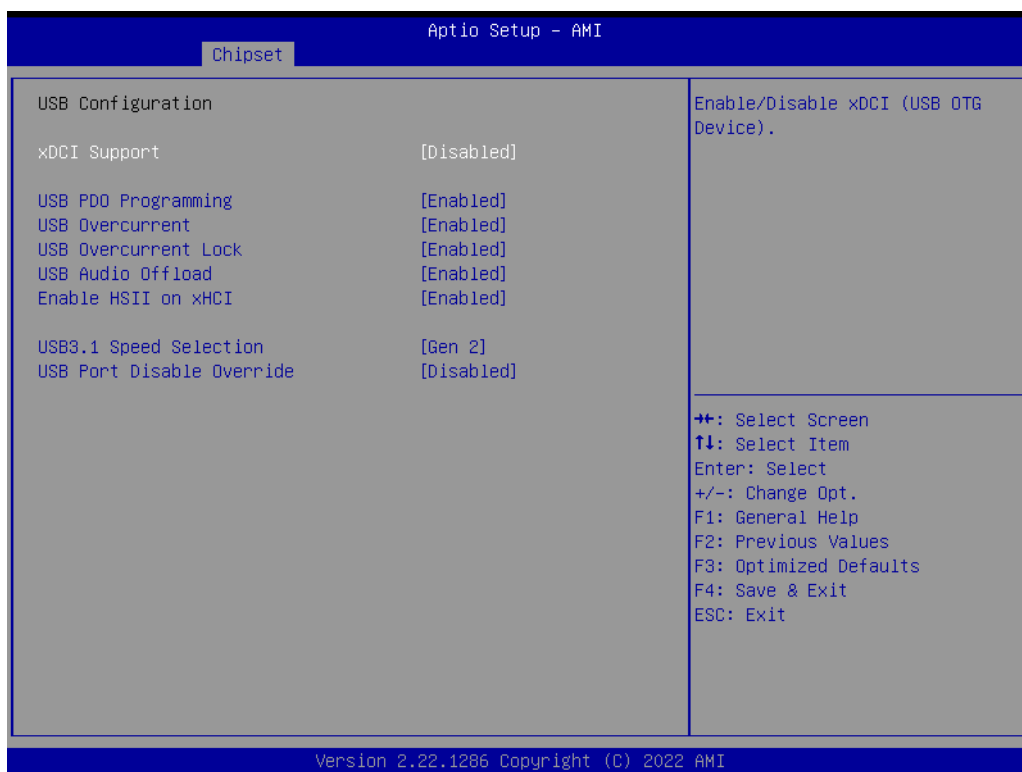
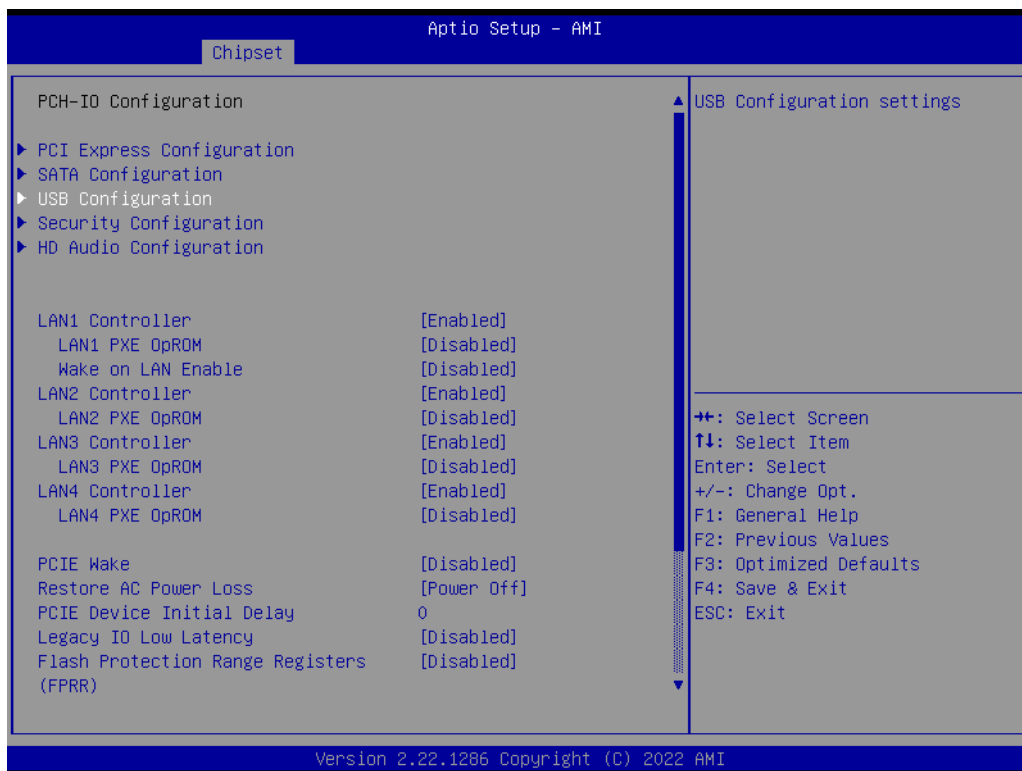

- xDCI Support
Enable/Disable xDCI (USB OTG Device).
- USB PDO Programming
Select 'Enabled' if Port Disable Override functionality is used.

- USB Overcurrent
Select 'Disabled' for pin-based debug. If pin-based debug is enabled but USB overcurrent is not disabled, USB DbC will not work.
- USB Overcurrent Lock
Select 'Enabled' if Overcurrent functionality is used. Enabling this will make xHCI controller consume the Overcurrent mapping data.
- USB Audio Offload
Enable/Disable USB Audio Offload functionality.
- Enable HSII on xHCI
Enable/Disable HSII feature. It may lead to increased power consumption.
- USB3.1 Speed Selection
USB3.1 Speed selection; Gen1 or Gen2.
- USB Port Disable Override
Selectively Enable/Disable the corresponding USB port from reporting a Device Connection to the controller.

■ Security Configuration

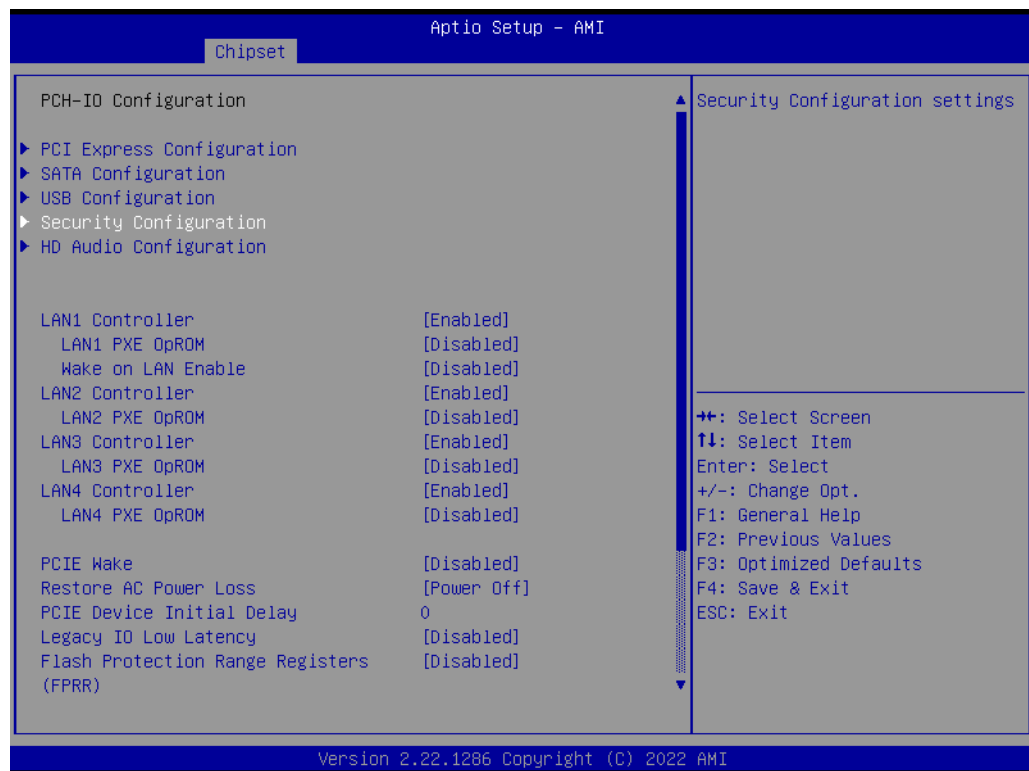



- RTC Memory Lock
Enable will lock bytes 38h-3Fh in the lower/upper 128-byte bank of RTC RAM.
- BIOS Lock
Enable/Disable the PCH BIOS Lock Enable feature. Required to be enabled to ensure SMM protection of flash.
- Force unlock on all GPIO pads
If Enabled, BIOS will force all GPIO pads to be in unlocked state.

■ HD Audio Configuration

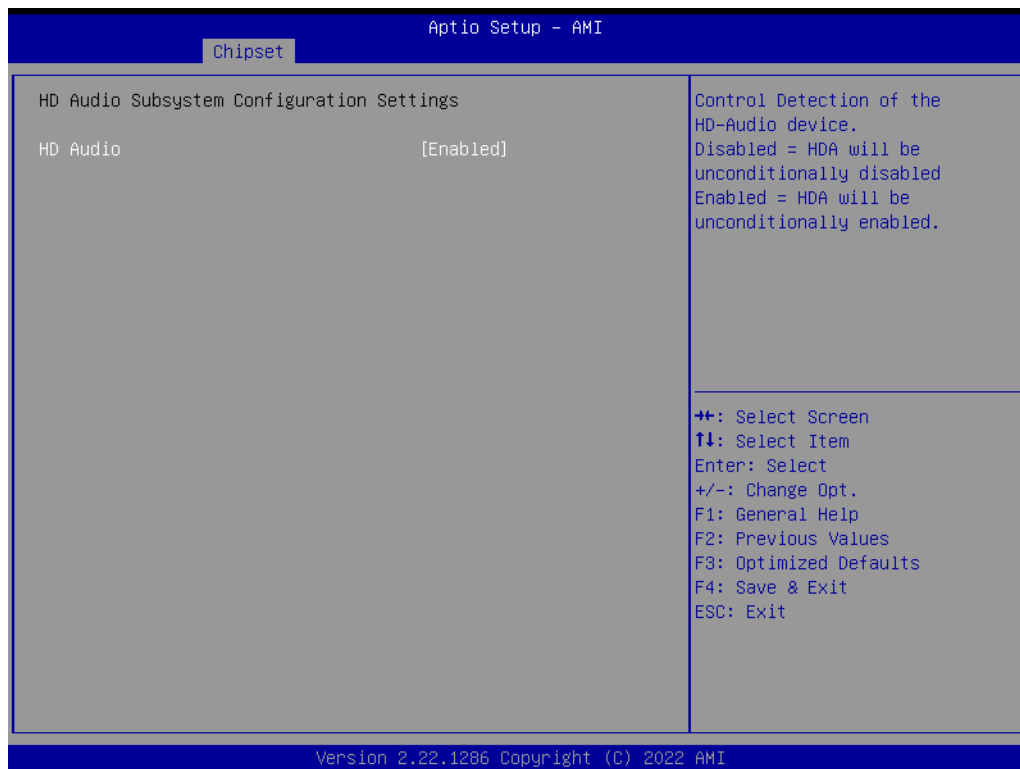
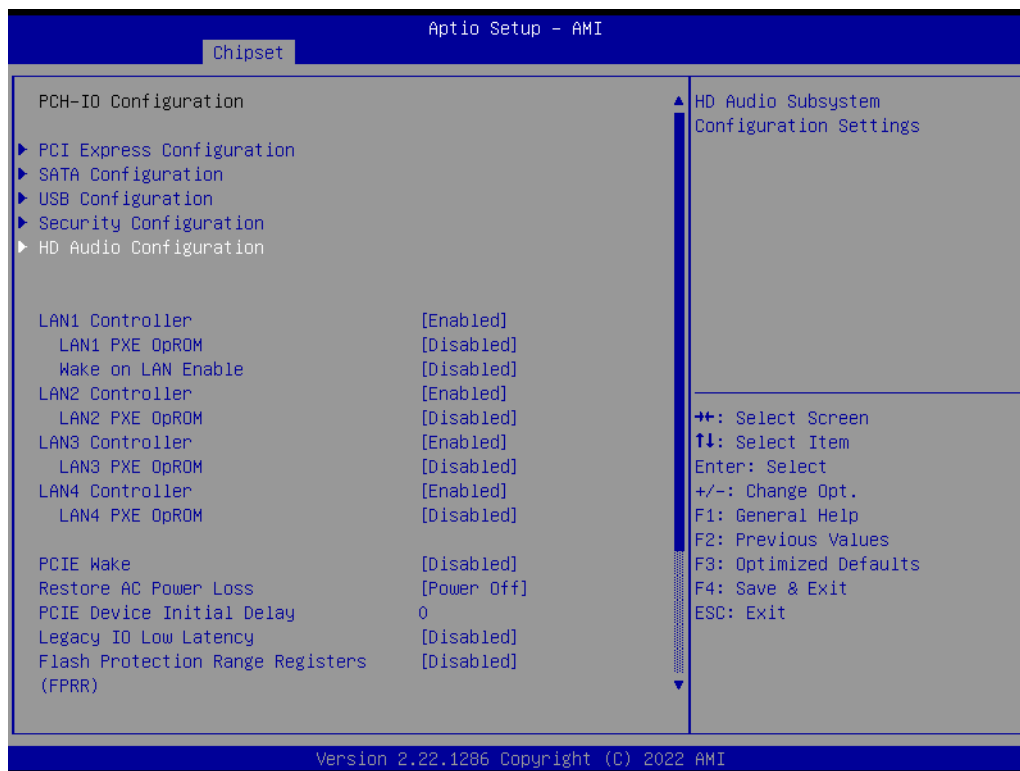

- HD Audio
 Control Detection of the HD-Audio device.

3.2.4 Security



- **Administrator Password**
Set Administrator Password.
- **User Password**
Set User Password.

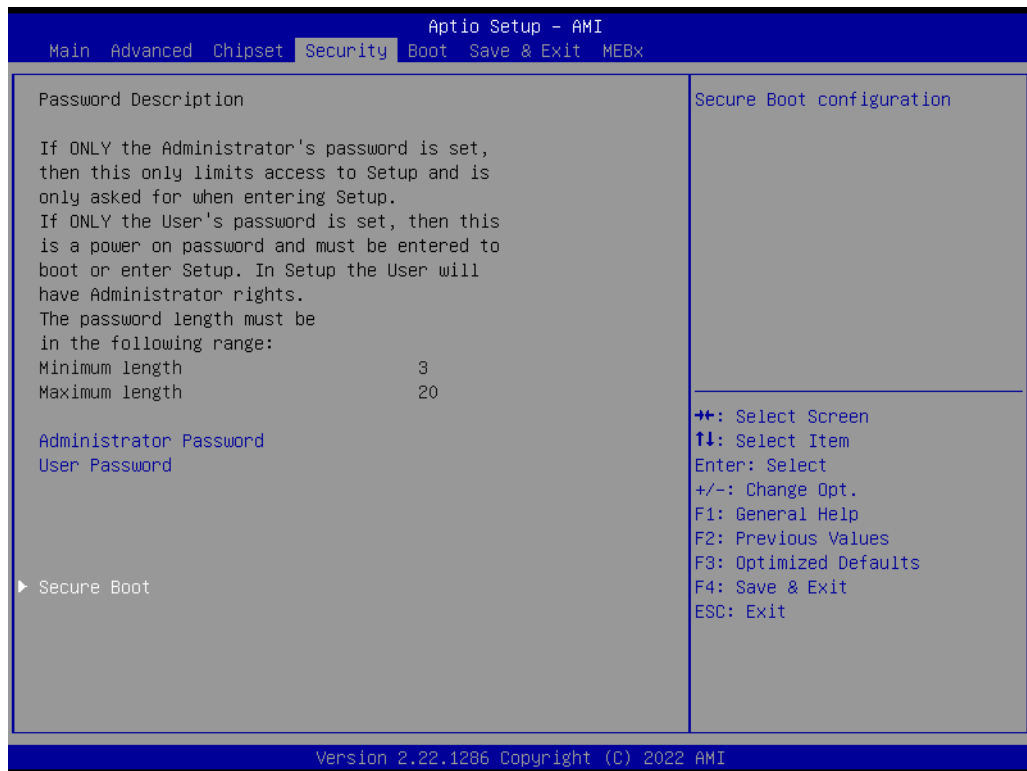

- Secure Boot
Secure Boot feature is Active if Secure Boot is Enabled, Platform Key (PK) is enrolled and the System is in User mode. The mode change requires platform reset.
- Secure Boot Mode
Secure Boot mode options: Standard or Custom.

3.2.5 Boot



- **Setup Prompt Timeout**
Number of seconds to wait for setup activation key. 65535 (0xFFFF) means indefinite waiting.
- **Bootup NumLock State**
Select the keyboard NumLock state.
- **Quiet Boot**
Enables or Disables the Quiet Boot option.

3.2.6 Save & Exit

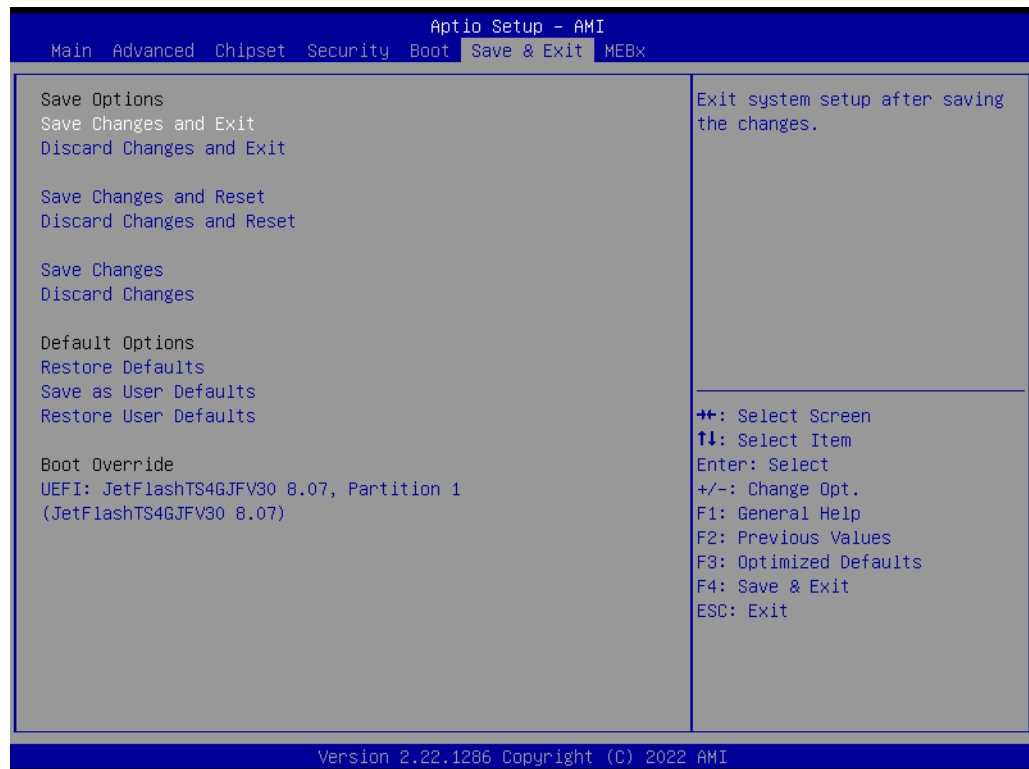

- **Save Changes and Exit**
Exit system setup after saving the changes.
- **Discard Changes and Exit**
Exit system setup without saving any changes.
- **Save Changes and Reset**
Reset the system after saving the changes.
- **Discard Changes and Reset**
Reset system setup without saving any changes.
- **Save Changes**
Save changes done so far to any of the setup options.
- **Discard Changes**
Discard changes done so far to any of the setup options.
- **Restore Defaults**
Restore/Load default values for all the setup options.
- **Save as User Defaults**
Save the changes done so far as User Defaults.
- **Restore User Defaults**
Restore the User Defaults to all the setup options.

3.2.7 MEBx



- **MEBx**
Set ME configuration.

ADVANTECH

Enabling an Intelligent Planet

www.advantech.com

Please verify specifications before quoting. This guide is intended for reference purposes only.

All product specifications are subject to change without notice.

No part of this publication may be reproduced in any form or by any means, electronic, photocopying, recording or otherwise, without prior written permission from the publisher.

All brand and product names are trademarks or registered trademarks of their respective companies.

© Advantech Co., Ltd. 2024