



**User Manual**

# **ARK-3532**

## **Fanless Embedded Box PC**

**ADVANTECH**

*Enabling an Intelligent Planet*

---

## **Attention!**

Please note:

This package contains a hard-copy user manual in Chinese for China CCC certification purposes. There is an English user manual included as a PDF file on the CD. Please disregard the Chinese hard copy user manual if the product is not to be sold and/or installed in China.

## Copyright

The documentation and the software included with this product are copyrighted 2021 by Advantech Co., Ltd. All rights are reserved. Advantech Co., Ltd. reserves the right to make improvements in the products described in this manual at any time without notice.

No part of this manual may be reproduced, copied, translated, or transmitted in any form or by any means without the prior written permission of Advantech Co., Ltd. Information provided in this manual is intended to be accurate and reliable. However, Advantech Co., Ltd. assumes no responsibility for its use, nor for any infringements of the rights of third parties, which may result from its use.

## Acknowledgments

Award is a trademark of Award Software International, Inc.

VIA is a trademark of VIA Technologies, Inc.

IBM, PC/AT, PS/2 and VGA are trademarks of International Business Machines Corporation.

Intel® and Pentium® are trademarks of Intel Corporation.

Microsoft Windows® is a registered trademark of Microsoft Corp.

RTL is a trademark of Realtek Semi-Conductor Co., Ltd.

ESS is a trademark of ESS Technology, Inc.

UMC is a trademark of United Microelectronics Corporation.

SMI is a trademark of Silicon Motion, Inc.

Creative is a trademark of Creative Technology LTD.

CHRONTEL is a trademark of Chrontel Inc.

All other product names or trademarks are properties of their respective owners.

For more information about this and other Advantech products, please visit our website at:

<http://www.advantech.com/>

<http://www.advantech.com/ePlatform/>

For technical support and service, please visit our support website at:

<http://support.advantech.com.tw/support/>

---

## Product Warranty (2 years)

Advantech warrants to you, the original purchaser, that each of its products will be free from defects in materials and workmanship for two years from the date of purchase.

This warranty does not apply to any products which have been repaired or altered by persons other than repair personnel authorized by Advantech, or which have been subject to misuse, abuse, accident, or improper installation. Advantech assumes no liability under the terms of this warranty as a consequence of such events.

Because of Advantech's high quality-control standards and rigorous testing, most of our customers never need to use our repair service. If an Advantech product is defective, it will be repaired or replaced at no charge during the warranty period. For out-of-warranty repairs, you will be billed according to the cost of replacement materials, service time and freight. Please consult your dealer for more details.

If you think you have a defective product, follow these steps:

1. Collect all the information about the problem encountered. (For example, CPU speed, Advantech products used, other hardware and software used, etc.) Note anything abnormal and list any onscreen messages you get when the problem occurs.
2. Call your dealer and describe the problem. Please have your manual, product, and any helpful information readily available.
3. If your product is diagnosed as defective, obtain an return merchandise authorization (RMA) number from your dealer. This allows us to process your return more quickly.
4. Carefully pack the defective product, a fully-completed Repair and Replacement Order Card and a photocopy proof of purchase date (such as your sales receipt) in a shippable container. A product returned without proof of the purchase date is not eligible for warranty service.
5. Write the RMA number visibly on the outside of the package and ship it prepaid to your dealer.

## Declaration of Conformity

### FCC Class B

Note: This equipment has been tested and found to comply with the limits for a Class B digital device, pursuant to part 15 of the FCC Rules. These limits are designed to provide reasonable protection against harmful interference in a residential installation.

This equipment generates, uses, and can radiate radio frequency energy and, if not installed and used in accordance with the instructions, may cause harmful interference to radio communications. However, there is no guarantee that interference will not occur in a particular installation. If this equipment does cause harmful interference to radio or television reception, which can be determined by turning the equipment off and on, the user is encouraged to try to correct the interference by one or more of the following measures:

- Reorient or relocate the receiving antenna.
- Increase the separation between the equipment and receiver.
- Connect the equipment into an outlet on a circuit different from that to which the receiver is connected.
- Consult the dealer or an experienced radio/TV technician for help.



## Technical Support and Assistance

1. Visit the Advantech website at [www.advantech.com/support](http://www.advantech.com/support) where you can find the latest information about the product.
2. Contact your distributor, sales representative, or Advantech's customer service center for technical support if you need additional assistance. Please have the following information ready before you call:
  - Product name and serial number
  - Description of your peripheral attachments
  - Description of your software (operating system, version, application software, etc.)
  - A complete description of the problem
  - The exact wording of any error messages

## Warnings, Cautions, and Notes

**Warning!** *Warnings indicate conditions, which if not observed, can cause personal injury!*



**Caution!** *Cautions are included to help you avoid damaging hardware or losing data. e.g.*



*There is a danger of a new battery exploding if it is incorrectly installed. Do not attempt to recharge, force open, or heat the battery. Replace the battery only with the same or equivalent type recommended by the manufacturer. Discard used batteries according to the manufacturer's instructions.*

**Note!** *Notes provide optional additional information.*



## Packing List

Before installation, please ensure the following items have been shipped:

- 1 x ARK-3532B Unit
- 1 x User Manual (Simplified Chinese)
- 1 x China RoHS
- 1 x Desk mounting kit
- 1 x WISE-DeviceOn
- 1 x McAfee Application Control Lite/Acronis Backup 11.7for Windows PC

## Ordering Information

Part No.	CPU	DDR4	Gbe	VGA	HDMI	Option 3rd display module	RS-232	RS-232/422/485	LAN	USB 3.2+3.0	MiniPCI e*	SI M	M.2	DC Inout	Expansion
ARK-3532B-00A1	LGA1200 Socket Type	Up to 64GB	4	1	1	1	2	4	2	8	1	1	1	9-36V DC	PCIex4+PCIex16
ARK-3532C-00A1	LGA1200 Socket Type	Up to 64GB	4	1	1	1	2	4	2	8	1	1	1	9-36V DC	PCIex4+2PCI
ARK-3532D-00A1	LGA1200 Socket Type	Up to 64GB	4	1	1	1	2	4	2	8	1	1	1	9-36V DC	PCIex4+2PCIex16

**Note!** CPU/Memory/Storage and operating system included by request.



## Default Packing List

Part Number	Description
36WSWPDOBUND11	WISE-DeviceOn
36WSWPDOBD0211	McAfee Application Control Lite/Acronis Backup 11.7
-	Simplified Chinese manual
-	China RoHS

## Optional Item for Default SKU

Part Number	Description
96PSA-A230W24P4-3	AC to DC adapter, DC 24V 230W, -20 ~ 60 °C (-4 ~ 140 °F)
1702002600	Power cable 3-pin 183 cm (6 ft), USA type
1702002605	Power cable 3-pin 183 cm (6 ft), EU type
1702031801	Power cable 3-pin 183 cm (6 ft), UK type
1700000237	Power cable 3-Pin 183 cm (6 ft), PSE type

# Safety Instructions

1. Read these safety instructions carefully.
2. Retain this user manual for future reference.
3. Disconnect the equipment from all AC outlets before cleaning. Use only a damp cloth for cleaning. Do not use liquid or spray detergent.
4. For pluggable equipment, the power outlet should be near the equipment and easily accessible.
5. Protect the equipment from humidity.
6. Place the equipment on a reliable surface during installation. Dropping or letting the equipment fall may cause damage.
7. The openings on the enclosure are for air convection and protect the equipment from overheating. Do not cover the openings.
8. The power outlet sockets should have grounded connections.
9. Position the power cord away from high-traffic areas. Do not place anything over the power cord.
10. All cautions and warnings on the equipment should be noted.
11. If the equipment is not used for a long time, disconnect the equipment from the power source to avoid damage from transient over-voltage.
12. Never pour liquid into an opening as this can cause fire or electrical shock.
13. Never open the equipment. For safety reasons, only qualified service personnel should open the equipment.
14. If one of the following occurs, have the equipment checked by service personnel:
  - The power cord or plug is damaged.
  - Liquid has penetrated into the equipment.
  - The equipment has been exposed to moisture.
  - The equipment is malfunctioning or does not operate according to the user manual.
  - The equipment has been dropped and damaged.
  - The equipment shows obvious signs of breakage.
15. Do not leave the equipment in an environment with a storage temperature of below  $-40\text{ }^{\circ}\text{C}$  ( $-40\text{ }^{\circ}\text{F}$ ) or above  $85\text{ }^{\circ}\text{C}$  ( $185\text{ }^{\circ}\text{F}$ ) as this may cause damage. The equipment should be stored in a controlled environment.
16. Any unverified component may cause unexpected damage. To ensure correct installation, always use the components (e.g., screws) provided in the accessory box.
17. **CAUTION:** The equipment is equipped with a battery-powered real-time clock circuit. There is a risk of explosion if a battery is incorrectly replaced. Replace only with same or equivalent type as recommended by the manufacturer. Discard all used batteries according to the manufacturer's instructions.
18. Always disconnect the power cord from the chassis before manually handling the hardware. Do not implement connections or configuration changes while the device is powered on. Sudden power surges may damage sensitive electronic components.
19. In accordance with IEC 704-1:1982 specifications, the sound pressure level at the operator's position should not exceed 70 dB (A).
20. The equipment should only be installed in -restricted access areas.
21. **DISCLAIMER:** These instructions are provided according to IEC 704-1 specifications.  
Advantech disclaims all responsibility for the accuracy of any statements contained herein.

22. Use a power cord connected to a socket-outlet with a grounded connection.
23. This product is intended to be supplied by a UL Listed power supply suitable for use at minimum Tma 50 °C (122 °F) whose output meets PS2 (or LPS), ES1 (or SELV) and output is rated: 9-36Vdc, 16.65-4.16A. Please contact Advantech for further information.
24. Never open the equipment. For safety reasons, the equipment should be opened by qualified service personnel only).
25. RESTRICTED ACCESS AREA: The equipment should only be installed in a Restricted Access Area.

## Consignes de Sécurité

1. Veuillez lire attentivement ces instructions de sécurité.
2. Veuillez conserver ce manuel de l'utilisateur pour référence ultérieure.
3. Veuillez débrancher cet équipement de la prise secteur avant le nettoyage. Utilisez un chiffon humide. Ne pas utiliser de détergent liquide ou pulvérisé pour le nettoyage. Utilisez une feuille ou un chiffon humide pour le nettoyage.
4. Pour les équipements enfichables, la prise de courant doit être à proximité de l'équipement et doit être facilement accessible.
5. S'il vous plaît garder cet équipement de l'humidité.
6. Posez cet équipement sur une surface fiable lors de l'installation. Une chute ou une chute pourrait causer des blessures.
7. Les ouvertures sur le boîtier sont destinées à la convection d'air, protégeant ainsi l'équipement de la surchauffe. **NE COUVREZ PAS LES OUVERTURES.**
8. La prise de courant doit avoir une connexion mise à la terre.
9. Placez le cordon d'alimentation de sorte que personne ne puisse marcher dessus.  
Ne placez rien sur le cordon d'alimentation.
10. Tous les avertissements et mises en garde sur l'équipement doivent être notés.
11. Si l'appareil n'est pas utilisé pendant une longue période, débranchez-le du secteur pour ne pas être endommagé par une surtension transitoire.
12. Ne jamais verser de liquide dans les ouvertures de ventilation; Cela pourrait provoquer un incendie ou un choc électrique.
13. N'ouvrez jamais l'équipement. Pour des raisons de sécurité, seul le personnel de maintenance qualifié doit ouvrir l'équipement.
14. Si l'une des situations suivantes se présente, faites vérifier le matériel par le personnel de service:
  - Le cordon d'alimentation ou la fiche est endommagé.
  - Un liquide a pénétré dans l'appareil.
  - L'équipement a été exposé à l'humidité.
  - L'équipement ne fonctionne pas bien ou vous ne pouvez pas le faire fonctionner conformément au manuel d'utilisation.
  - Equipment L'équipement est tombé et a été endommagé.
  - Equipment L'équipement présente des signes évidents de rupture.
15. Ne laissez pas cet équipement dans un environnement où la température de stockage peut être inférieure à -40 °C (-40 °F) ou supérieure à 85 °C (185 °F). Cela pourrait endommager l'équipement. L'équipement doit être dans un environnement contrôlé.
16. Tout composant non vérifié peut causer des dommages inattendus. Pour garantir une installation correcte, veuillez toujours utiliser les composants (ex. Vis) fournis avec la boîte d'accessoires.

17. **ATTENTION:** L'ordinateur est équipé d'un circuit d'horloge temps réel alimenté par batterie. Il y a un risque d'explosion si la batterie est remplacée de manière incorrecte. Remplacez uniquement avec le même type ou un type équivalent recommandé par le fabricant. Jetez les piles usagées conformément aux instructions du fabricant.
18. Débranchez toujours complètement le cordon d'alimentation de votre châssis lorsque vous utilisez du matériel. Ne faites pas de connexion quand l'appareil est sous tension. Les composants électroniques sensibles peuvent être endommagés par des surtensions soudaines.
19. Niveau de pression acoustique au poste de l'opérateur selon la norme CEI 704-1: 1982 n'est pas supérieur à 70 dB (A).
20. L'équipement ne doit être installé que dans une zone d'accès restreint.
21. **AVERTISSEMENT:** Cet ensemble d'instructions est donné conformément à la norme CEI 704-1. Advantech décline toute responsabilité quant à l'exactitude des déclarations contenues dans ce.
22. Au moyen d'un cordon d'alimentation connecté à une prise de courant avec mise à la terre.
23. Ce produit est destiné à être alimenté par un bloc d'alimentation homologué UL adapté à une utilisation à T<sub>ma</sub> 50 degrés C min. dont la sortie est conforme à PS2 (ou LPS), ES1 (ou SELV) et dont la sortie est nominale: 9-36Vdc, 16.65-4.16A, si besoin d'aide supplémentaire, veuillez contacter Advantech pour plus d'informations.
24. N'ouvrez jamais l'équipement. Pour des raisons de sécurité, l'équipement ne doit être ouvert que par du personnel de service qualifié (Par personne qualifiée).



# Contents

<b>Chapter 1</b>	<b>General Introduction .....</b>	<b>1</b>
1.1	Introduction .....	2
1.2	Product Features.....	3
1.2.1	General .....	3
1.2.2	Display .....	3
1.2.3	Ethernet .....	3
1.3	Chipset.....	4
1.3.1	Functional specifications.....	4
1.3.2	SUSI 4.0.....	5
1.4	Mechanical Specifications.....	6
1.4.1	Dimensions .....	6
1.4.2	Weight.....	7
1.5	Power Requirements.....	7
1.5.1	System power .....	7
1.6	Operating Environment Specifications .....	8
1.6.1	Operating temperature.....	8
1.6.2	Relative humidity.....	8
1.6.3	Storage temperature .....	8
1.6.4	Safety.....	8
1.6.5	EMC .....	8
<b>Chapter 2</b>	<b>Hardware Configuration.....</b>	<b>9</b>
2.1	Introduction .....	10
2.2	Jumpers .....	10
2.2.1	Jumper Description .....	10
2.2.2	Jumper List .....	10
	Table 2.1: Jumper List.....	10
2.2.3	Jumper Locations.....	11
	Figure 2.1 Jumper Layout.....	11
2.2.4	Jumper Settings.....	12
2.3	Connectors.....	14
2.3.1	ARK-3532 External I/O Locations .....	14
	Figure 2.2 ARK-3532 Front and Rear I/O Connector Diagram..	14
	Figure 2.3 COM Connector.....	14
	Table 2.2: COM Connector Pin Assignments.....	14
	Table 2.3: COM Connector Pin Assignments .....	15
	Figure 2.4 Ethernet Connector .....	15
	Table 2.4: Ethernet Connector Pin Assignments.....	16
	Figure 2.5 HDMI Receptacle Connector.....	16
	Table 2.5: HDMI Connector Pin Assignments .....	16
	Figure 2.6 VGA Connector .....	16
	Table 2.6: VGA Connector Pin Assignments.....	17
	Figure 2.7 DIO Connector.....	17
	Table 2.7: DIO Connector Pin Assignment.....	17
	Figure 2.8 Power ON/OFF Button .....	18
	Figure 2.9 LED Indicators .....	18
	Figure 2.10 USB 3.2 Gen 1/2 Connector.....	18
	Table 2.8: USB3.2 Gen1/2 Connector Pin Assignments .....	18
2.4	Installation .....	19
2.4.1	CPU/Memory Installation .....	19
2.4.2	External HDD/SSD Installation .....	21
2.4.3	Mounting Kit Installation.....	21
2.4.4	M.2 Module/MiniPCIe Module/Internal SIM Card Slot Installation ..	

2.4.5	Paste the Thermal pad .....	23
-------	-----------------------------	----

## **Chapter 3 BIOS Settings ..... 25**

3.1	Introduction .....	26
3.2	Entering the Setup .....	27
3.2.1	Main Setup.....	27
3.2.2	Advanced BIOS Features Setup.....	28
3.2.3	Chipset Configuration .....	63
3.2.4	Security.....	82
3.2.5	Boot .....	84
3.2.6	Save & Exit .....	85

## **Appendix A Watchdog Timer Sample Code ..... 87**

A.1	EC Watchdog Timer Sample Code.....	88
-----	------------------------------------	----

## **Appendix B Fixing the LAN order ..... 89**

B.1	Problem Statement .....	90
B.2	Addressing the LAN Order.....	91



# Chapter 1

## General Introduction

This chapter details background information on the ARK-3532 series.

---

## 1.1 Introduction

Advantech's ARK-3532 is an intelligent, high-performance, fanless desktop system powered by 10th Gen. Intel® Core™ LGA1200 and Core i3/i5/i7 65W CPU processors. ARK-3532 supports a maximum 65W processor and broad temperature ranges (-20 ~ 60 °C / -4 ~ 140 °F). It also provides multiple I/O — including 6 x COM, 4 x GbE, 4 x USB 3.2, 4 x USB 3.0, 1 x miniPCIe (share with mSATA), 1 x M.2 (E key), 1 x SIM holder, 1 x Line out, TPM 2.0 (optional) and 2 x 2.5" SATA III hard drive bays. (Up to 4 x 2.5" SATAIII HDD bays by optional AMK-A0035).

### **Rugged Multi-Functional Design**

ARK-3532 adopts an advanced thermal design for its desktop processor solution. All models are fanless, and deliver several unique features. These include wide operating temperatures (-20 ~ 60 °C / -4 ~ 140 °F), diverse expandability options, and structural strengthening. It supports diverse I/O interfaces — including 4 x Intel® GbE, 4 x USB 3.2, 4 x USB 3.0, 2 x 2.5" HDD, 1 x miniPCIe, 1 x M.2 (E key) 4 x RS-232/422/485 and 2 x RS-232 COM ports.

### **Built-in Intelligent Management Tools — Advantech SUSI API and WISE-DeviceOn**

Advantech SUSI API provides a valuable suite of programmable APIs such as multi-level watchdog, hardware monitoring, system restoration, and other user-friendly interfaces.

SUSI API is an intelligent self-management cross platform tool that monitors the system's status for problems and takes action in the event of abnormalities. SUSI API offers a boot up guarantee in critical, low-temperature environments so systems can automatically recover when voltages dip. SUSI API makes the entire system more reliable and intelligent. ARK-3532 also supports Advantech's own WISE-DeviceOn software which provides easy remote management so users can monitor, configure, and control a large number of terminals to make maintenance and system recovery simpler.

## 1.2 Product Features

### 1.2.1 General

- **CPU:** Intel® 10th Gen. Xeon® W and Core™ i3/i5/i7/i9 processor LGA1200 desktop processor (up to 65W)
- **System Chipset:** Intel® W480E
- **BIOS:** AMI EFI 256Mbit
- **System Memory:** DDR4 2933Mhz up to 64GB
- **Watchdog Timer:** Single chip Watchdog 255-level interval timer, setup by software
- **I/O Interface:** 4 x RS232/422/485, 2 x RS232
- **USB:** 4 x USB 3.2, 2 x USB 3.0, and 2 x independent USB 3.0
- **Audio:** High Definition Audio (HD), and Line-out/Mic-in
- **Storage:** 2 x 2.5" HDD drive bays (15mm/0.59 in height) and 1 x mSATA (Up to 4 x 2.5" SATA III HDD bays by optional AMK-A0035)
- **Expansion Interface:**
  - 1 x Full size MiniPCle (support mSATA and 1 with SIM)
  - 1 x M.2 (E key for Wi-Fi, suggested installation at Advantech manufacturing)
  - Add-on Card Slot:3532B for 1 Slot PCIe4+ 1 Slot PCIe16, 3532C for 1 Slot PCIe4 + 2 Slot PCI,3532D for 1 Slot PCIe4 + 2 Slot PCI + 1 Slot PCIe16
- **TPM:** TPM 2.0 (Optional)

### 1.2.2 Display

- **Controller:** According to customer-specified CPU selection
- **Resolution:**
  - VGA: supports 1920x1200 @ 60 Hz
  - HDMI: supports HDMI 1.4, 4096 x 2160 @ 30 Hz
- **Triple Display:**
  - VGA+HDMI (Default)
  - HDMI+HDMI (Support by TPN)
  - DP+VGA (Support by TPN)
  - DP+HDMI (Support by TPN)

### 1.2.3 Ethernet

- **Chipset:**
  - LAN1 Intel® i219LM
  - LAN2/3/4 Intel® i210AT
- **Speed:** 10/100/1000 Mbps

---

## 1.3 Chipset

### 1.3.1 Functional specifications

#### 1.3.1.1 Processor

- Processor Supports 10th Gen. Intel® LGA1200 processor (up to 65W)
- Memory Supports DDR4 2933 MHz up to 64GB
- 2 x 260-pin SODIMM socket type

#### 1.3.1.2 Chipset

##### Internal Graphics Features

- Direct x 12, OpenGL 4.5
- VGA + HDMI
- Intel® Display Power saving technology 6.0

##### Video Accelerator

- HW accelerated Media Decode: H.265/HEVC, H.264/MPEG-4 AVC, MPEG-2, VC-1/WMV9, JPEG/MJPEG, VP8 and VP9
- HW accelerated Media Encode: H. H.265/HEVC, H.264/MPEG-4 AVC, MPEG-2, JPEG/MJPEG and VP8

##### SATA Interface

###### Intel® W480E:

- Supports several optional selections of Serial ATA III
- Supports SATA data transfer rates of up to 6 Gb/s
- Integrated AHCI controller
- Supports mSATA socket

##### USB Interface

###### Intel® W480E chip supports:

- 1 x XHCI Host Controller, supporting SuperSpeed USB 3.2 Gen1/Gen2
- 1 x EHCI Host Controllers, supporting HighSpeed USB 2.0 ports
- Supports wake-up from sleep states S3
- Maximum 500mA for each USB port

##### Power Management

###### Intel® W480E chip supports:

- Supports ACPI
- ACPI-defined power states (processor driven C states)
- ACPI Power Management Timer
- SMI# generation

###### BIOS Intel® W480E chip supports:

### 1.3.1.3 Others

#### Serial Ports

- 6 x serial ports
- Supports IRQ Sharing among serial ports under Microsoft

#### Windows OS

- COM3, COM4, COM5, COM6: RS-232/422/485
- COM1, COM2: RS-232

#### Ethernet

##### LAN1 Intel i219LM, LAN2/3/4 Intel i210IT

- Supports 10/100/1000 Mbps
- LAN Connectors: Phone Jack RJ45 8P 90D (F)

#### Audio

##### Audio Codec: ALC888S-VD2-GR

- Compliant with HD Audio specifications
- Supports 16/20/24-bit DAC and 16/20/24-bit ADC resolution
- Supports: Speaker-out, Mic-in
- Audio Connectors: 1 x headphone jack \*

**Battery Backup** Battery 3V/210 mAh with WIRE x 1

**TPM** TPM 2.0

### 1.3.2 SUSI 4.0

- SUSI API
- Sequence Control Supported
- DIO 16-bit programmable DIO
- Watchdog Timer Multi-level WDT (set by Advantech iManager)
- Programmable 1-255 sec / min
- Hardware Monitor CPU Temperature / input Current / input Voltage
- System Information Running HR / Boot record

## 1.4 Mechanical Specifications

### 1.4.1 Dimensions

#### ARK-3532B/ARK-3532C

(W x H x D) 156 x 204 x 230 mm/6.14 x 8.03 x 9.05 in

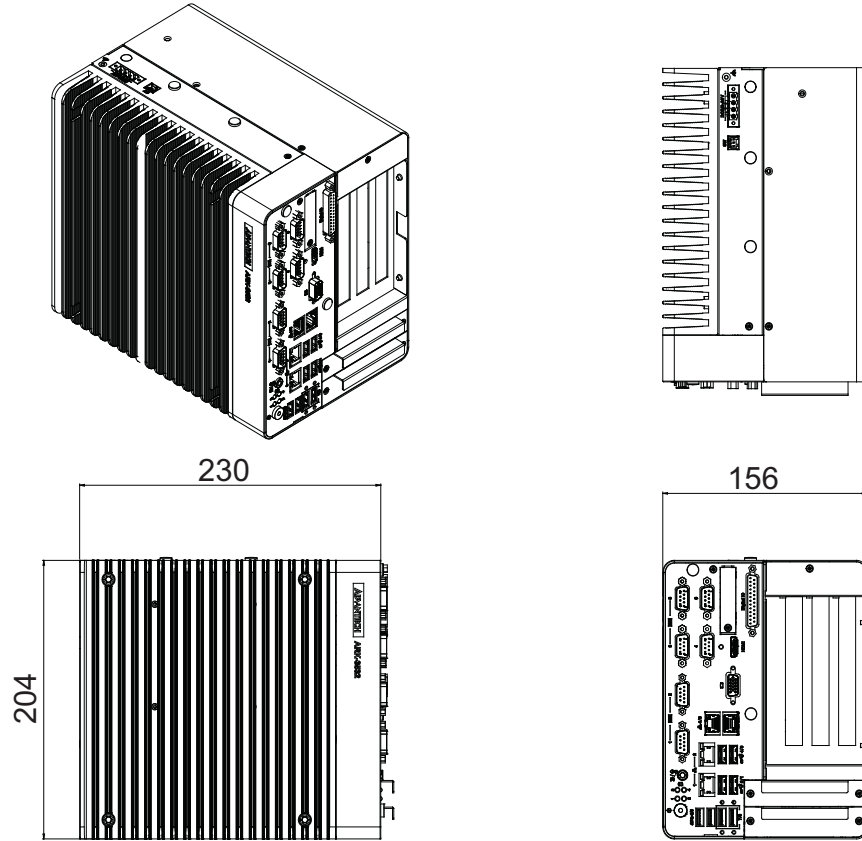

**ARK-3532D**

(W x H x D) 197.2 x 204 x 230 mm/7.7 x 8.03 x 9.05 in

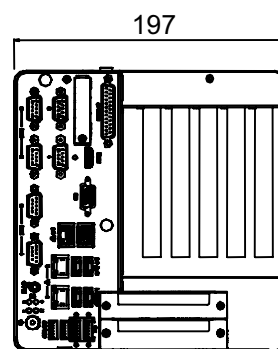
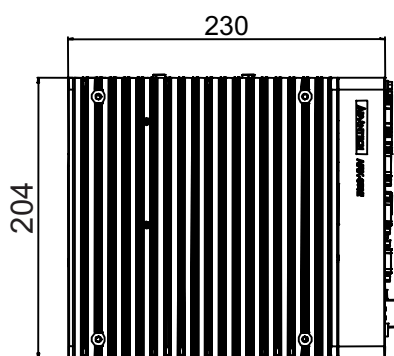
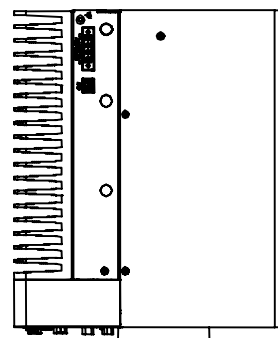
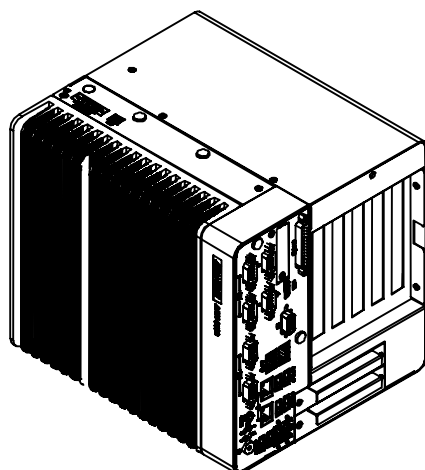
**1.4.2 Weight**

ARK3532B/ARK3532C: 5.7 kg (12.5 lb)

ARK3532D: 6.41 kg (14.1 lb)

**1.5 Power Requirements****1.5.1 System power**

- **Minimum Power Input:** 9 ~ 36VDC
- **Optional Adapter:**
  - 150W @ 19V/7.89A power adapter (optional)
  - 230W @ 24V/9.58A power adapter (optional)

---

## 1.6 Operating Environment Specifications

### 1.6.1 Operating temperature

- With extended peripherals: -20 ~ 60 °C (-4 ~ 140 °F) with 0.7m/s air flow

### 1.6.2 Relative humidity

- 95% @ 40 °C (104 °F) (non-condensing)

### 1.6.3 Storage temperature

- -40 ~ 85 °C (-40 ~ 185 °F)

### 1.6.4 Safety

- UL, CB, CCC, BSMI

### 1.6.5 EMC

- CE/FCC Class B, CCC, BSMI



# Chapter 2

Hardware  
Configuration

## 2.1 Introduction

The following sections show the internal jumper settings and the external connector pin assignments for different applications.

## 2.2 Jumpers

### 2.2.1 Jumper Description

You may configure ARK-3532 to match the needs of your application by setting jumpers. A jumper is a metal bridge used to close an electric circuit. It consists of two metal pins and a small metal clip (often protected by a plastic cover) that slides over the pins to connect them. To close a jumper, you connect the pins with the clip. To open a jumper, remove the clip. Sometimes a jumper will have three pins, labeled 1, 2, and 3. In this case you would connect either pins 1 and 2, or 2 and 3.

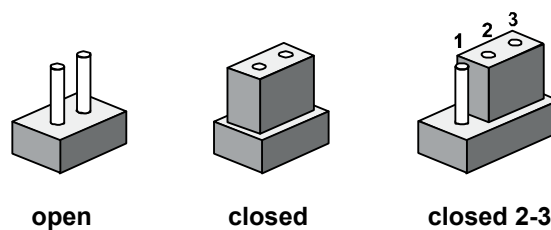

The jumper settings are schematically depicted in this manual as follows.

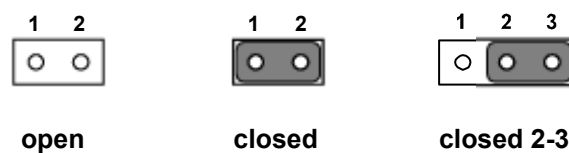

A pair of needle-nose pliers may be helpful when working with jumpers. If you have any doubts about the best hardware configuration for your application, contact your local distributor or sales representative before you make any changes. Generally, you simply need a standard cable to make most connections.

### 2.2.2 Jumper List

**Table 2.1: Jumper List**

J1	Auto Power On Setting (MB)
JCMOS1	Clear CMOS (MB)
MPWR_SEL1	MINI PCIE Power Setting (MB)
J_CFG2	PCIE X16 Lane reversal Setting (MB)
J_CFG5	PCIE X16 Bifurcation Setting (MB)
J_CFG6	PCIE X16 Bifurcation Setting (MB)
J1(AMO-I028)	COM3 RI power setting (on AMO-I028)

### 2.2.3 Jumper Locations

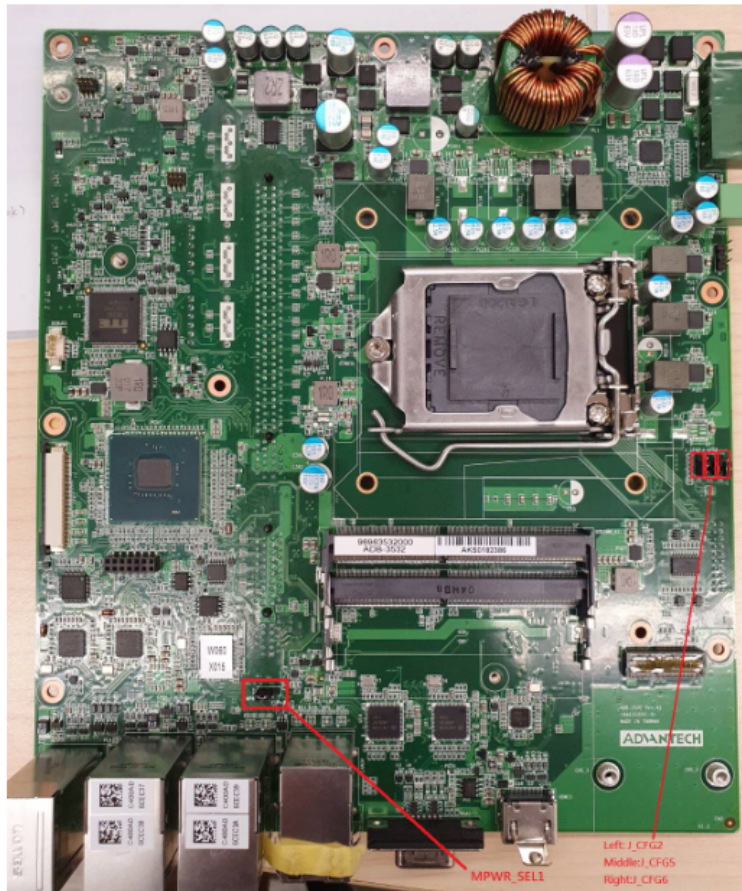
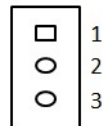

Figure 2.1 Jumper Layout

## 2.2.4 Jumper Settings

### 2.2.4.1 Auto Power On Setting for J1

<b>J1 Auto Power On Setting</b>	
Part Number	1655303020
Footprint	WHL3V-2M
Description	WAFER BOX 3P 2.0 mm 180D(M) DIP 2001-WS-3
Setting	Function
(1-2)	Auto Power On
(2-3)	Power Button for Power On (Default)



### 2.2.4.2 Clear CMOS Setting for JCMOS1

<b>JCMOS1 Clear CMOS Setting</b>	
Part Number	1653003101
Footprint	HD_3x1P_79_D
Description	PIN HEADER 3x1P 2.0 mm 180D(M) DIP 2000-13 WS
Setting	Function
(1-2)	Normal Operation (Default)
(2-3)	Clear CMOS

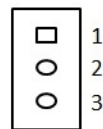

### 2.2.4.3 MINI PCIE Power setting for MPWR\_SEL1

<b>MPWR_SEL1 Power Setting</b>	
Part Number	1653003101
Footprint	HD_3x1P_79_D
Description	PIN HEADER 3x1P 2.0 mm 180D(M) DIP 2000-13 WS
Setting	Function
(1-2)	3.3V (Default)
(2-3)	3.8V for 5G module

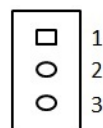

#### 2.2.4.4 PCIE X16 Lane reversal setting for J\_CFG2

J_CFG2 PCIE X16 Lane reversal Setting	
Part Number	1653003101
Footprint	HD_3x1P_79_D
Description	PIN HEADER 3x1P 2.0 mm 180D(M) DIP 2000-13 WS
Setting	Function
(1-2)	0: Lane numbers reversed (Default)
(2-3)	1: Normal operations

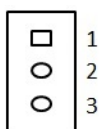

#### 2.2.4.5 PCIE X16 Bifurcation setting for J\_CFG5 and J\_CFG6

J_CFG5 and J_CFG6 PCIE X16 Bifurcation Setting	
Part Number	1653003101
Footprint	HD_3x1P_79_D
Description	PIN HEADER 3x1P 2.0mm 180D(M) DIP 2000-13 WS
Setting	Function
(1-2)	1 (Default)
(2-3)	0

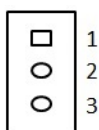

CFG[6:5]: PCI Express\* Bifurcation

00 = 1 x8, 2 x4 PCI Express\*

01 = reserved

10 = 2 x8 PCI Express\*

11 = 1 x16 PCI Express\* (Default)

#### 2.2.4.6 COM3 RI power setting J1 (AMO-I028) on AMO-I028 card

J1 (AMO-I028) RI power setting	
Part Number	1653003201
Footprint	HD_3x2P_79_D
Description	PIN HEADER 3x2P 2.0mm 180D(M) DIP 21N22050
Setting	Function
(1-2)	Normal (default)
(3-4)	+5V
(5-6)	+12V

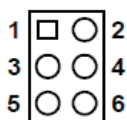

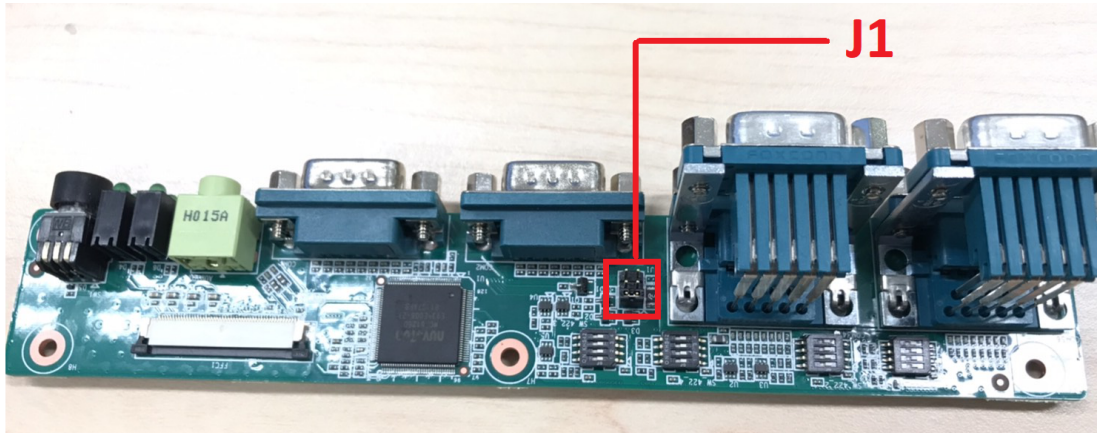

## 2.3 Connectors

### 2.3.1 ARK-3532 External I/O Locations

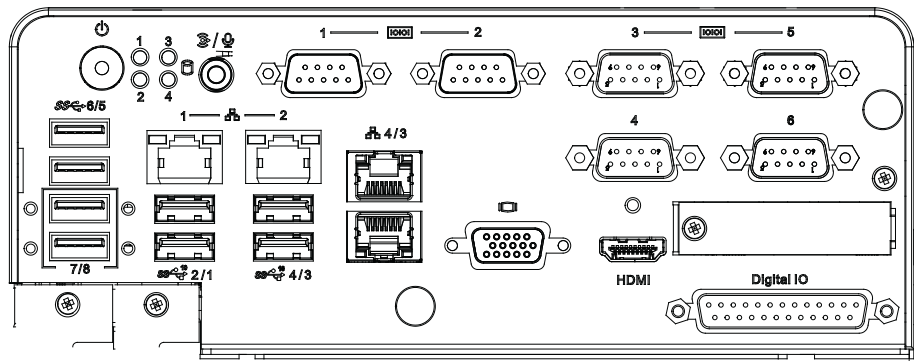

Figure 2.2 ARK-3532 Front and Rear I/O Connector Diagram

#### 2.3.1.1 COM Connector

ARK-3532 provides up to 6 D-sub 9-pin connectors, which offers RS-232/422/485 serial communication interface ports. The default setting is RS-232, the mode RS-422/485 of ARK-3532 COM3/4/5/6 can be supported via the BIOS settings. COM1/2 supports RS-232.

##### ■ COM3~COM6

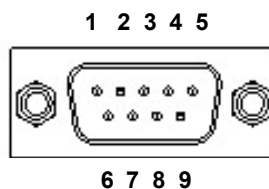

Figure 2.3 COM Connector

Table 2.2: COM Connector Pin Assignments

	RS-232	RS-422	RS-485
Pin	Signal Name	Signal Name	Signal Name
1	DCD	Tx-	DATA-
2	RxD	Tx+	DATA+



**Table 2.2: COM Connector Pin Assignments**

3	TxD	Rx+	NC
4	DTR	Rx-	NC
5	GND	GND	GND
6	DSR	NC	NC
7	RTS	NC	NC
8	CTS	NC	NC
9	RI	NC	NC

**Note!** NC represents “No Connection”.

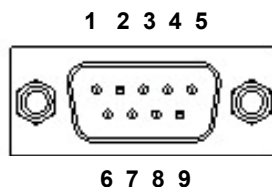

#### ■ COM1~COM2

**Table 2.3: COM Connector Pin Assignments**

RS-232	
Pin	Signal Name
1	DCD
2	RxD
3	TxD
4	DTR
5	GND
6	DSR
7	RTS
8	CTS
9	RI

#### 2.3.1.2 Ethernet Connector (LAN)

ARK-3532 is equipped with up to 4 x (LAN3/4 are optional by TPN support) Ethernet controllers that are fully compliant with IEEE 802.3u 10/100/1000 Mbps CSMA/CD standards. These Ethernet ports provide a standard RJ-45 jack connector with LED indicators on the front side that demonstrate its Active/Link status (Green LED) and Speed status (Green/Orange LED).

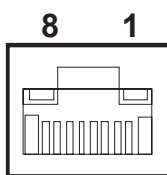
**Figure 2.4 Ethernet Connector**

**Table 2.4: Ethernet Connector Pin Assignments**

Pin	10/100/1000BaseT Signal Name
1	TX+
2	TX-
3	RX+
4	MDI2+
5	MDI2-
6	RX-
7	MDI3+
8	MDI3-

**2.3.1.3 HDMI Connector**

An integrated, 19-pin receptacle connector HDMI Type A Interface is provided. The HDMI link supports resolutions up to 3840 x 2160 @ 30 Hz.

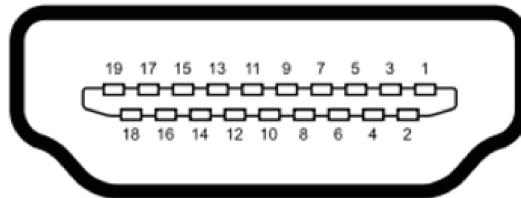
**Figure 2.5 HDMI Receptacle Connector****Table 2.5: HDMI Connector Pin Assignments**

Pin	Signal Name	Pin	Signal Name
1	TMDS Data 2+	2	TMDS Data 2 shield
3	TMDS Data 2-	4	TMDS Data 1+
5	TMDS Data 1 shield	6	TMDS Data 1-
7	TMDS Data 0+	8	TMDS Data 0 shield
9	TMDS Data 0-	10	TMDS clock+
11	TMDS clock shield	12	TMDS clock-
13	CEC	14	Reserved
15	SCL	16	SDA
17	DDC/CEC Ground	18	+5V
19	Hot Plug Detect		

**2.3.1.4 VGA Connector**

ARK-3532 provides an integrated 15-pin female VGA digital video interface, which supports up to 1920 x 1200 @ 60 Hz. Please refer to Table 2.6 for its pin assignments.

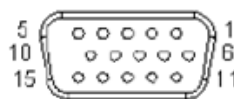
**Figure 2.6 VGA Connector**



**Table 2.6: VGA Connector Pin Assignments**

Pin	Signal Name	Pin	Signal Name
1	Red	2	Green
3	Blue	4	NC
5	GND	6	GND
7	GND	8	GND
9	NC	10	GND
11	NC	12	DDAT
13	H-SYNC	14	V-SYNC
15	DCLK		

### 2.3.1.5 DIO Connector

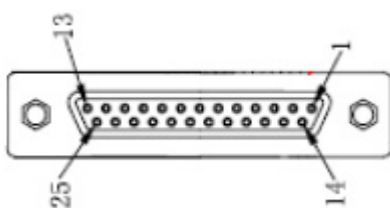
**Figure 2.7 DIO Connector****Table 2.7: DIO Connector Pin Assignment**

Pin	Signal Name	Pin	Signal Name
1	GND	14	GND
2	Port0 D0	15	Port1 D8
3	Port0 D1	16	Port1 D9
4	Port0 D2	17	Port1 D10
5	Port0 D3	18	Port1 D11
6	Port0 D4	19	Port1 D12
7	Port0 D5	20	Port1 D13
8	Port0 D6	21	Port1 D14
9	Port0 D7	22	Port1 D15
10	+5V	23	+5V
11	NC	24	NC
12	NC	25	NC
13	NC		

**Note!** NC represents “No Connection”.



### 2.3.1.6 Power On/Off Button

ARK-3532 has a Power On/Off button with LED indicators on the front side that show “On” (Green LED) and “Off/Suspend” statuses (Orange LED). The Power button supports dual functions: Soft Power - On/Off (Instant off or Delay 4 Seconds then off), and Suspend.



Figure 2.8 Power ON/OFF Button

### 2.3.1.7 Audio Connector

ARK-3532 features one phone jack connector that supports stereo Line Out or Mic In audio ports. The audio chip is controlled by ALC888 and compliant with the Azalea standards.

### 2.3.1.8 LED Indicators

There are four LEDs on the front panel that indicate the system’s status: HDD LED is for HDD status.

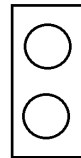

Figure 2.9 LED Indicators

### 2.3.1.9 USB3.2 Gen2 and Gen1

ARK-3532 supports 4 x USB 3.2 (Gen2, 10G), 2 x USB 3.2 (Gen1, 5G), and 2 x Independent USB 3.2 (Gen1, 5G) interfaces. The USB interfaces comply with USB UHCI, Rev. 3.0 standards. Please refer to Table 2.5 for its pin assignments. USB 3.2 Gen1/2 connectors contain legacy pins to interface with USB 2.0 devices, and a new set of pins for USB 3.2 Gen1/2 connectivity.

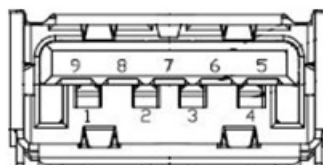

Figure 2.10 USB 3.2 Gen 1/2 Connector

Table 2.8: USB3.2 Gen1/2 Connector Pin Assignments

Pin	Signal Name	Pin	Signal Name
1	+5V	2	USB_data-
3	USB_data+	4	GND
5	SSRX-	6	SSRX+
7	GND	8	SSTX-
9	SSTX+		

### 2.3.1.10 Remote Switch Connector

ARK-3532 provides the remote switch connector for power on/off with a external cable. From the left to the right are Reset, GND, and Power Switch On.



## 2.4 Installation

### 2.4.1 CPU/Memory Installation

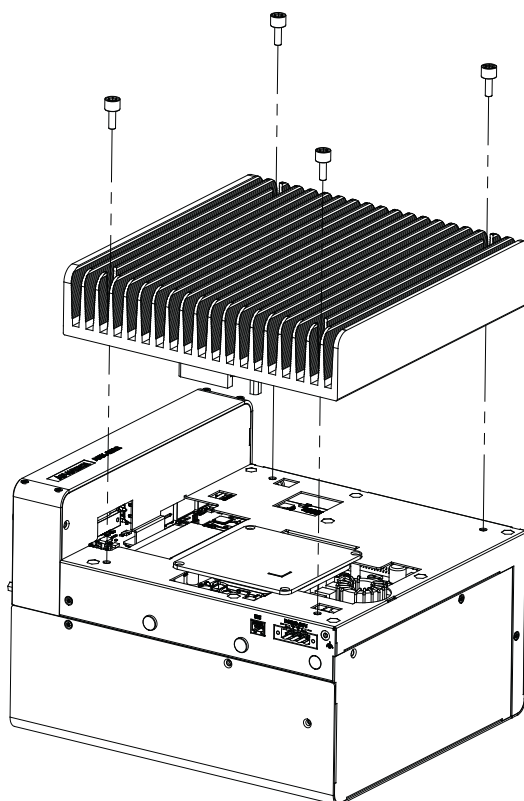

1. Unscrew the 4 screws on the top cover, and remove the top cover.

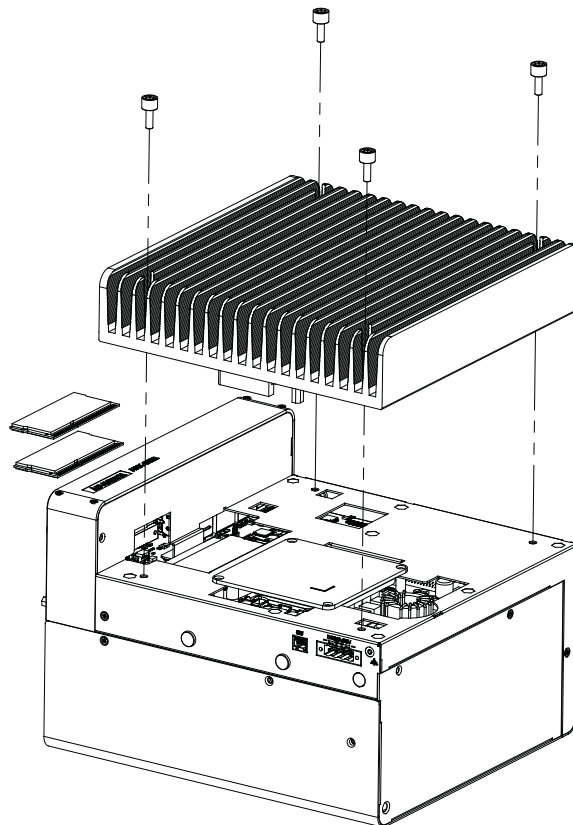
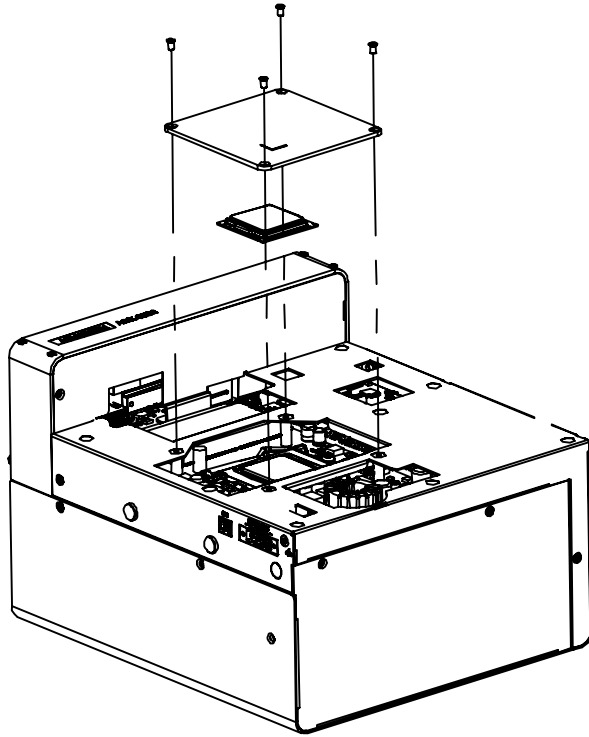

2. Install the CPU (LGA1151) and memory into the system.
3. Replace the top cover.

## 2.4.2 External HDD/SSD Installation

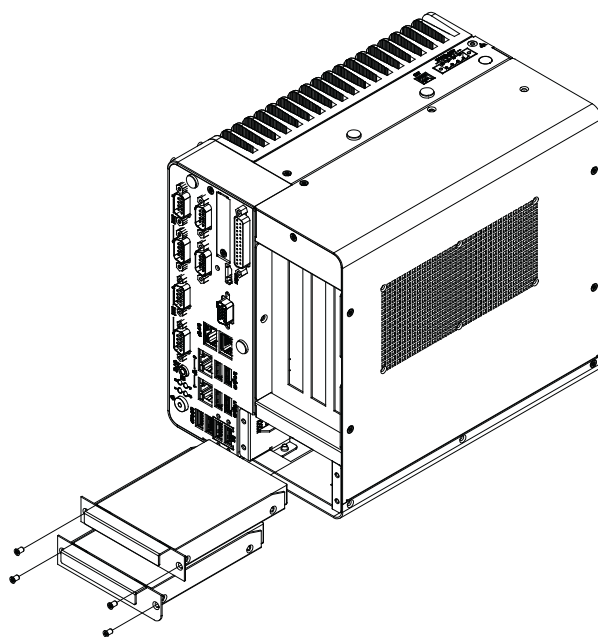

1. Unscrew the 2 x screws on the hard drive bay
2. Install HDD/SSD with 4 x screws on the HDD/SSD tray.
3. Push back the hard drive bay into the system and secure it using the same screws.

## 2.4.3 Mounting Kit Installation

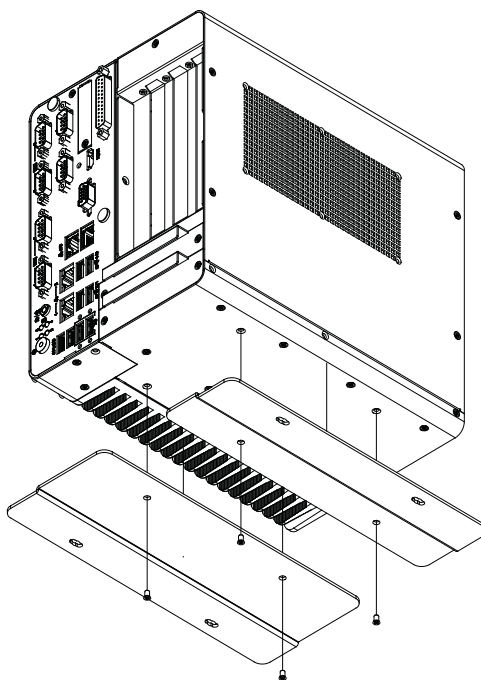

1. Take the mounting kit and 4 screws (M3x6L) out of the accessory box.

2. Screw one of the 2 screws (M3x6L) on left and right side and secure the system horizontally.

#### 2.4.4 M.2 Module/MiniPCle Module/Internal SIM Card Slot Installation

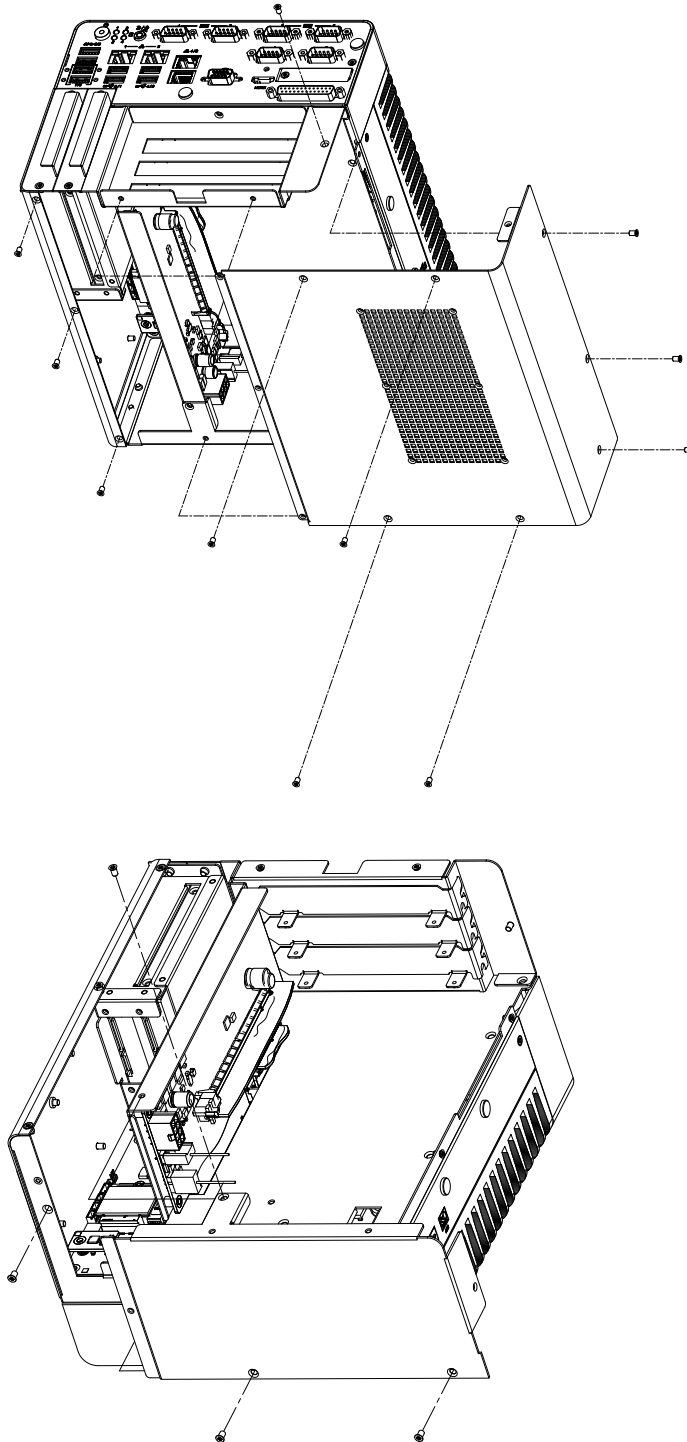

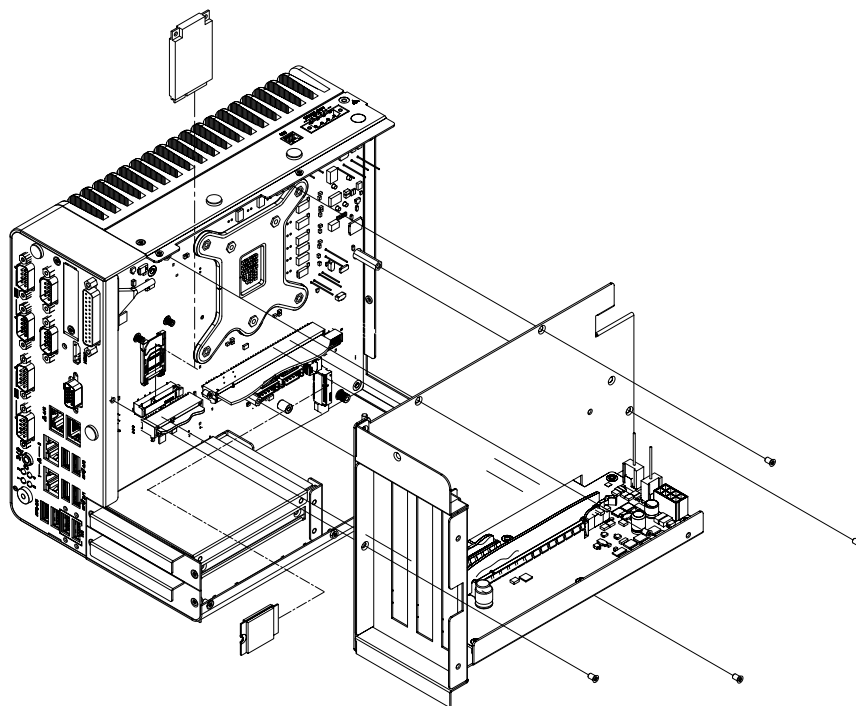

### 2.4.5 Attaching the Thermal pad

1. Take the thermal pad from the accessory box.
2. Paste the 30 x 30 x 0.2 mm (1.18 x 1.18 x .007 in) thermal pad to the CPU (as illustrated above).
3. Paste the 46 x 46 x 1 mm (1.8 x 1.8 x .03 in) piece to the Copper block (as illustrated below).

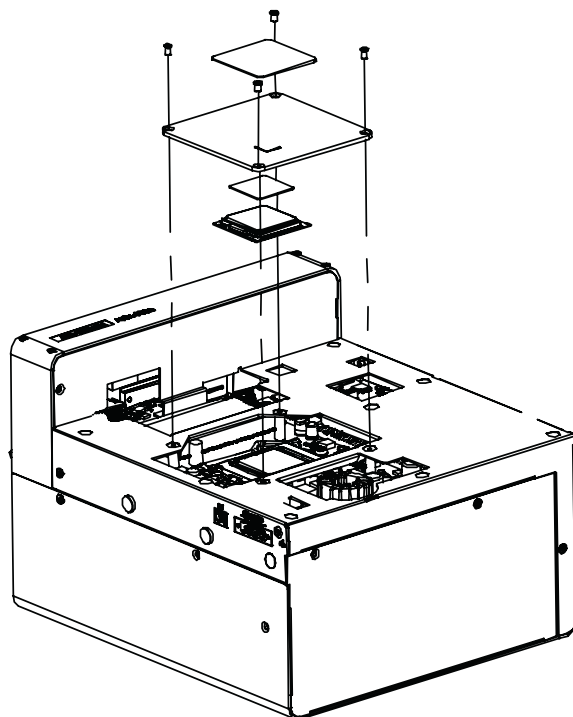





# Chapter 3

## BIOS Settings

## 3.1 Introduction

AMIBIOS has been integrated into motherboards for over two decades. With the AMIBIOS Setup program, users can modify BIOS settings and control various system features. This chapter describes the basic navigation of the ARK-3532 BIOS setup screens.

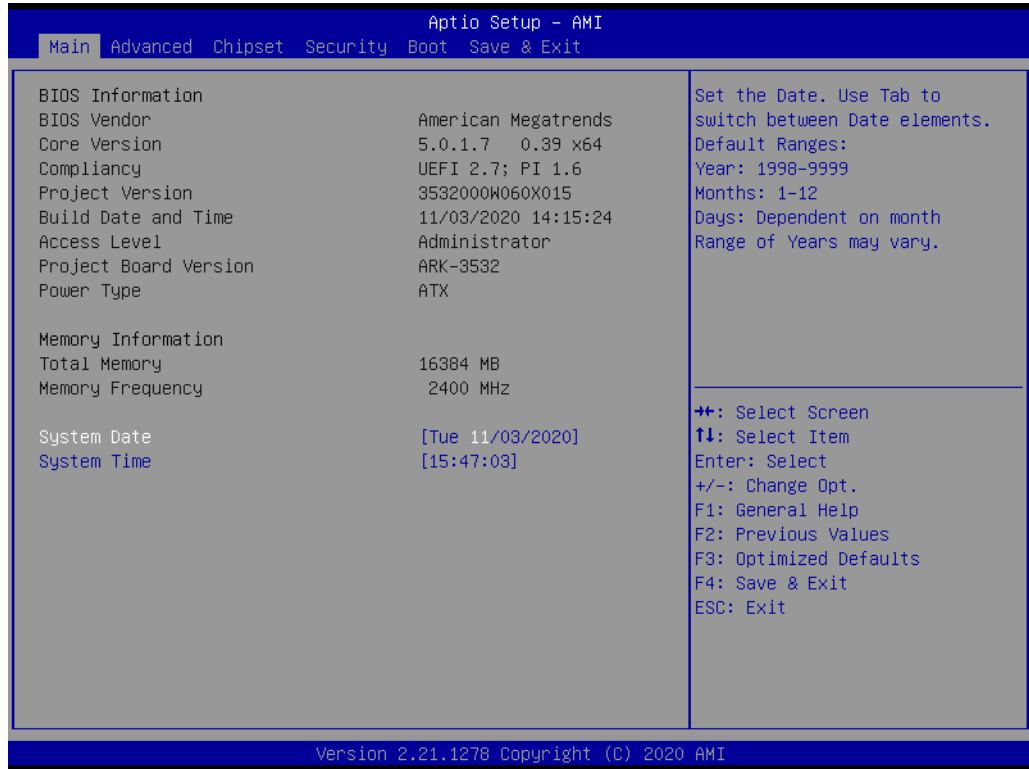

AMI's BIOS ROM has a built-in setup program that allows users to modify the basic system configuration. This information is stored in flash ROM so it retains the Setup information when the power is turned off.

## 3.2 Entering the Setup

Turn on the computer and check for the patch code. If there is a number assigned to the patch code, it means that BIOS supports your CPU. If there is no number assigned to the patch code, please contact an Advantech application engineer to obtain an up-to-date patch code file. This will ensure that your CPU's system status is valid. After ensuring that you have a number assigned to the patch code, press <DEL> and you will immediately be allowed to enter Setup.

### 3.2.1 Main Setup

When users first enter the BIOS Setup Utility, they will enter the Main setup screen. Users can always return to the Main setup screen by selecting the Main tab. There are two Main Setup options. They are described in this section. The Main BIOS Setup screen is shown below.

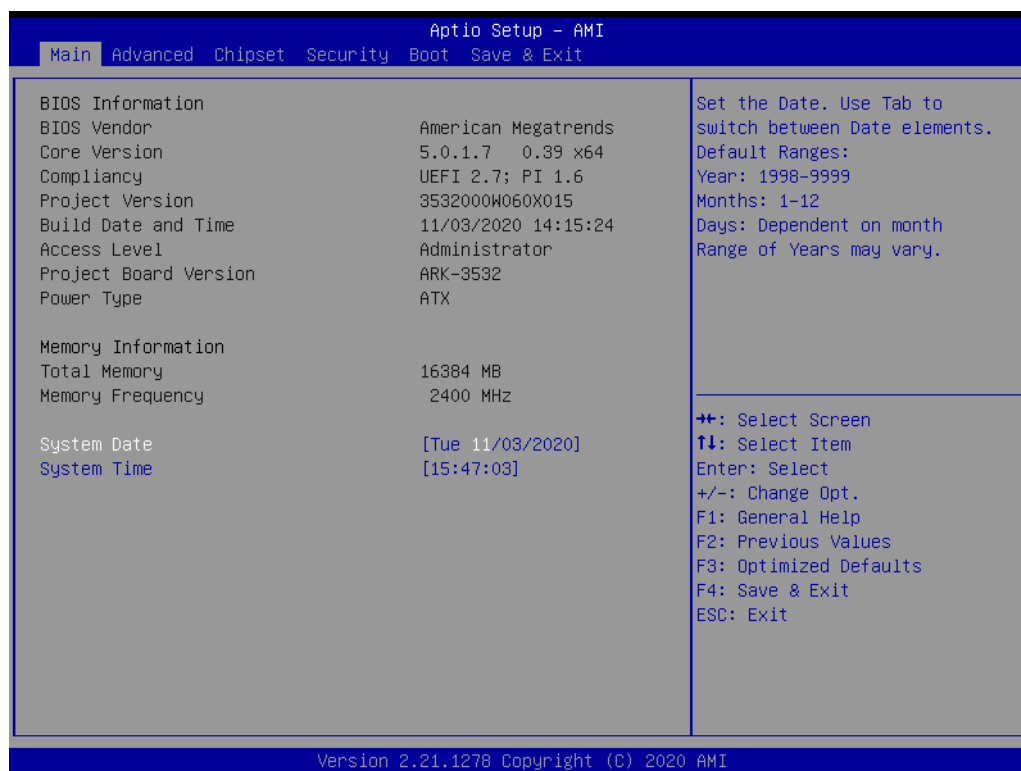

The Main BIOS setup screen has two main frames. The left frame displays all the options that can be configured. Grayed-out options cannot be configured; options in blue can. The right frame displays the key legend.

Above the key legend is an area reserved for a text message. When an option is selected in the left frame, it is highlighted in white. Often a text message will accompany it.

#### System time / System date

Use this option to change the system time and date. Highlight System Time or System Date using the <Arrow> keys. Enter new values through the keyboard. Press the <Tab> key or the <Arrow> keys to move between fields. The date must be entered in MM/DD/YY format. The time must be entered in HH:MM:SS format.

## 3.2.2 Advanced BIOS Features Setup

Select the Advanced tab from the ARK-3532 setup screen to enter the Advanced BIOS Setup screen. Users can select any item in the left frame of the screen, such as CPU Configuration, to go to the sub menu for that item. Users can display an Advanced BIOS Setup option by highlighting it using the <Arrow> keys. All Advanced BIOS Setup options are described in this section. The Advanced BIOS Setup screens are shown below. The sub menus are described on the following pages.

### 3.2.2.1 Connectivity Configuration

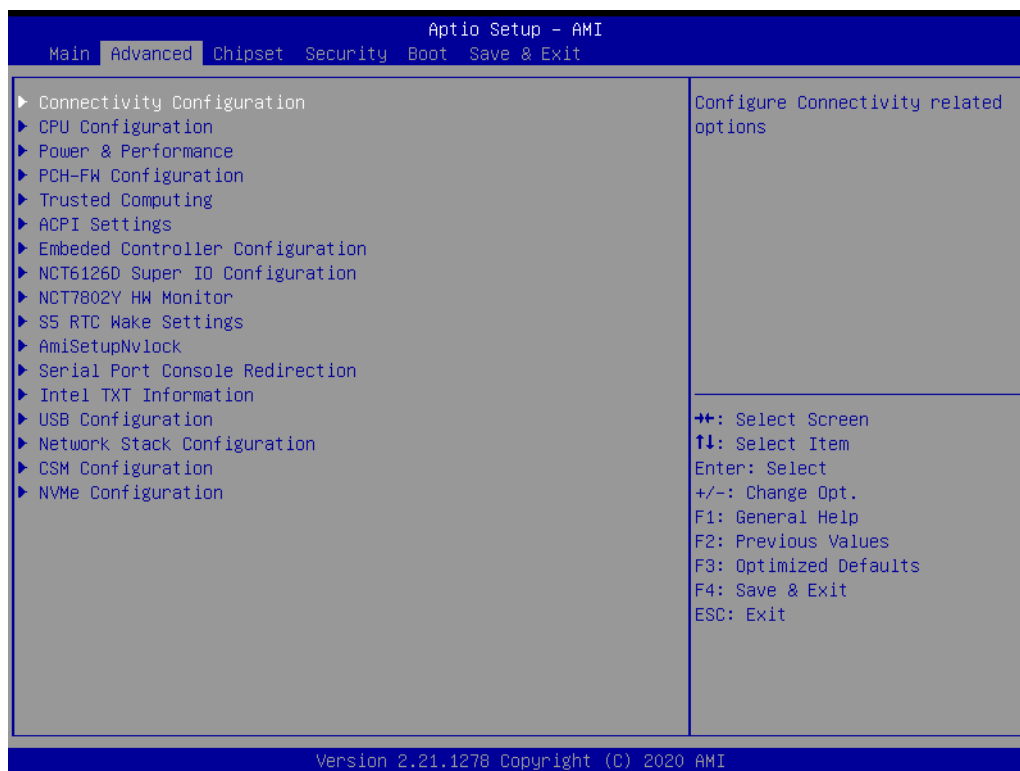

- **CNVi Mode**  
This option configures connectivity.
- **Discrete Bluetooth Module**  
Serial IO UART0 needs to be enabled to select BT Module.
- **Advanced settings**  
Configure ACPI objects for wireless devices.
- **WWAN Configuration**



- WWAN Device  
Enable or Disable M.2 WWAN Device.

### 3.2.2.2 CPU Configuration

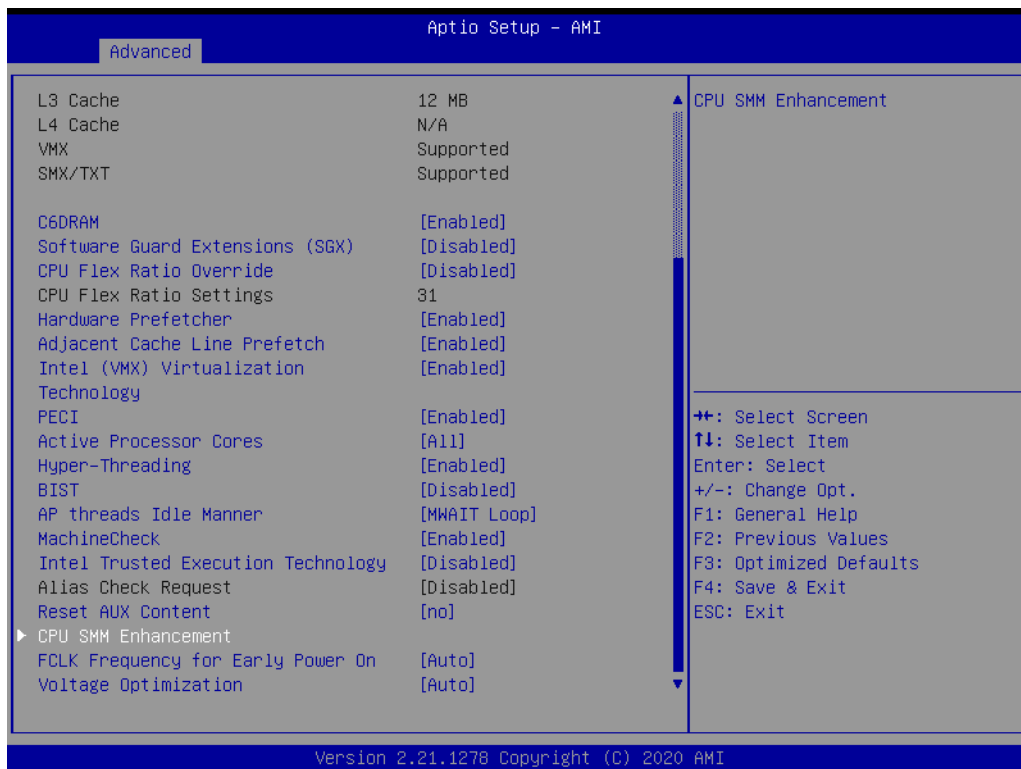
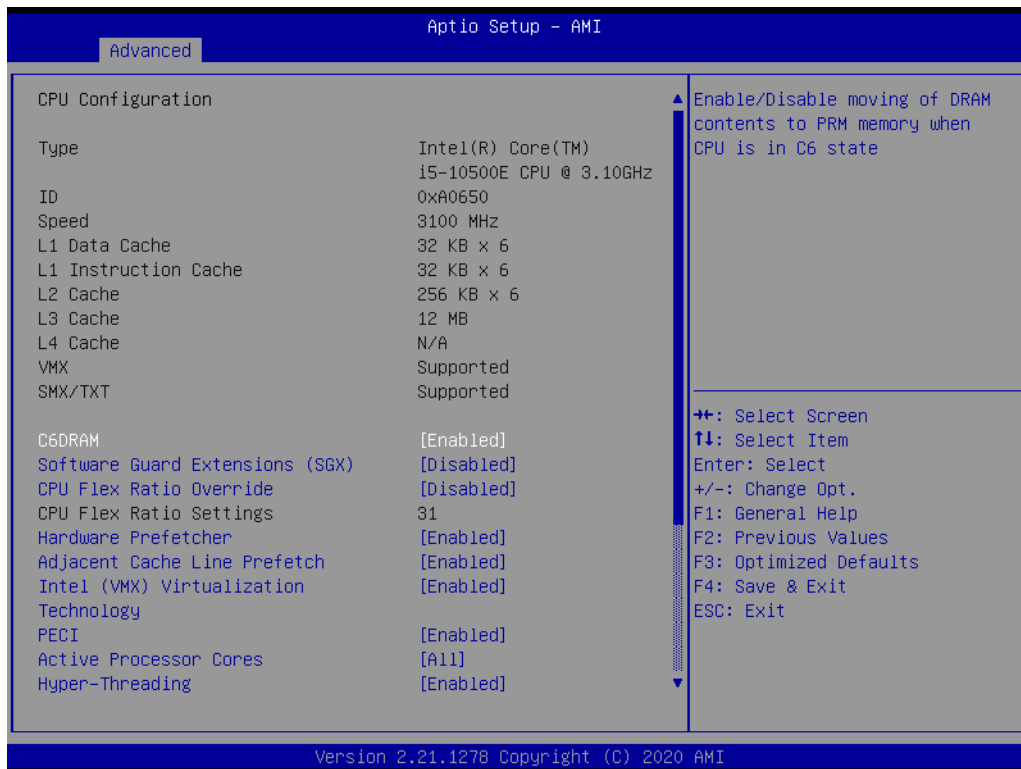

- **C6DRAM**  
Enable/Disable moving of DRAM contents to PRM memory when CPU is in C6 state.
- **Software Guard Extensions (SGX)**  
Enable/Disable Software Guard Extensions (SGX).

- **CPU Flex Ratio Override**  
Enable/Disable CPU Flex Ratio Programming.
- **CPU Flex Ratio Settings**  
This value must be between Max Efficiency Ratio (LFM) and Maximum non-turbo ratio set by Hardware (HFM).
- **Hardware Prefetcher**  
To turn on/off the MLC streamer prefetcher.
- **Adjacent Cache Line Prefetch**  
To turn on/off prefetching of adjacent cache lines.
- **Intel (VMX) Virtualization Technology**  
When enabled, a VMM can utilize the additional hardware capabilities provided by Vanderpool Technology.
- **PECI**  
Enable/Disable PECI.
- **Active Processor Cores**  
Number of cores to enable in each processor package.
- **Hyper-Threading**  
Enable or Disable Hyper-Threading Technology.
- **BIST**  
Enable/Disable BIST (Built-in Self Test) on reset
- **AP threads Idle Manner**  
AP threads Idle Manner for waiting signal to run.
- **MachineCheck**  
Enable/Disable Machine Check.
- **Intel Trusted Execution Technology**  
Enables utilization of additional hardware capabilities provided by Intel® Trusted Execution Technology.
- **Alias Check Request**  
Enables Txt Alias Checking capability.
- **Reset AUX Content**  
Reset TPM Aux content. Txt may not functional after AUX content gets reset.
- **FCLK Frequency for Early Power On**  
FCLK frequency can take values of 400MHz, 800MHz and 1GHz.(1GHz not supported for ULT/ULX SKUs)
- **Voltage Optimization**  
Auto: This Option will honor the Silicon default values;  
ENABLE - Mobile SKU's,  
DISABLE - Rest of all SKUs other than Mobile.

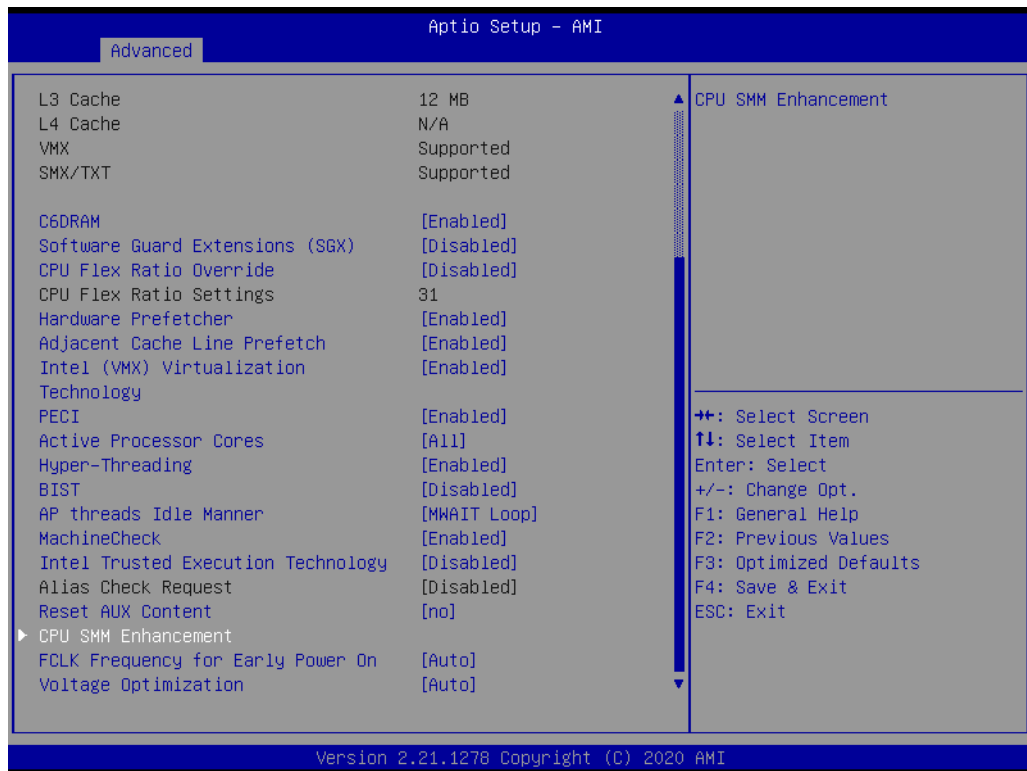

- SMM Use Delay Indication  
Enable/Disable usage of SMM\_DELAYED MSR for MP sync in SMI.
- SMM Use Block Indication  
Enable/Disable usage of SMM\_BLOCKED MSR for MP sync in SMI.
- DGR+NR11 / NR10 Support  
Select DGR with Nifty Rock11 or Nifty Rock10 Feature.



### 3.2.2.3 Power and Performance – CPU Power Management Control

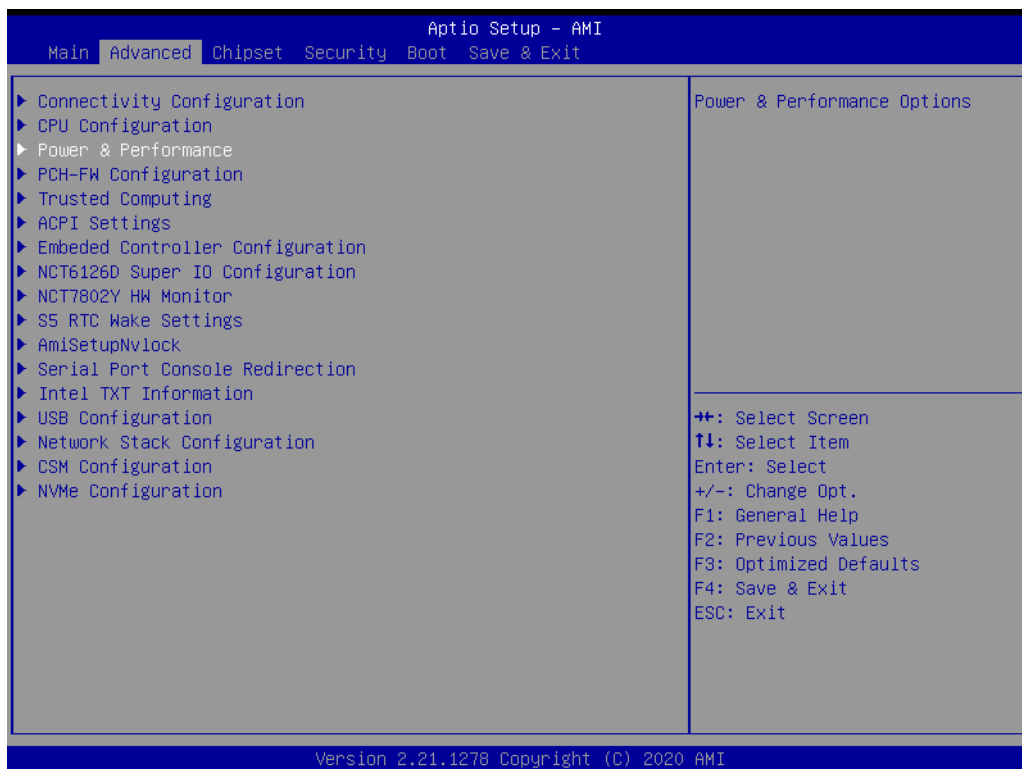

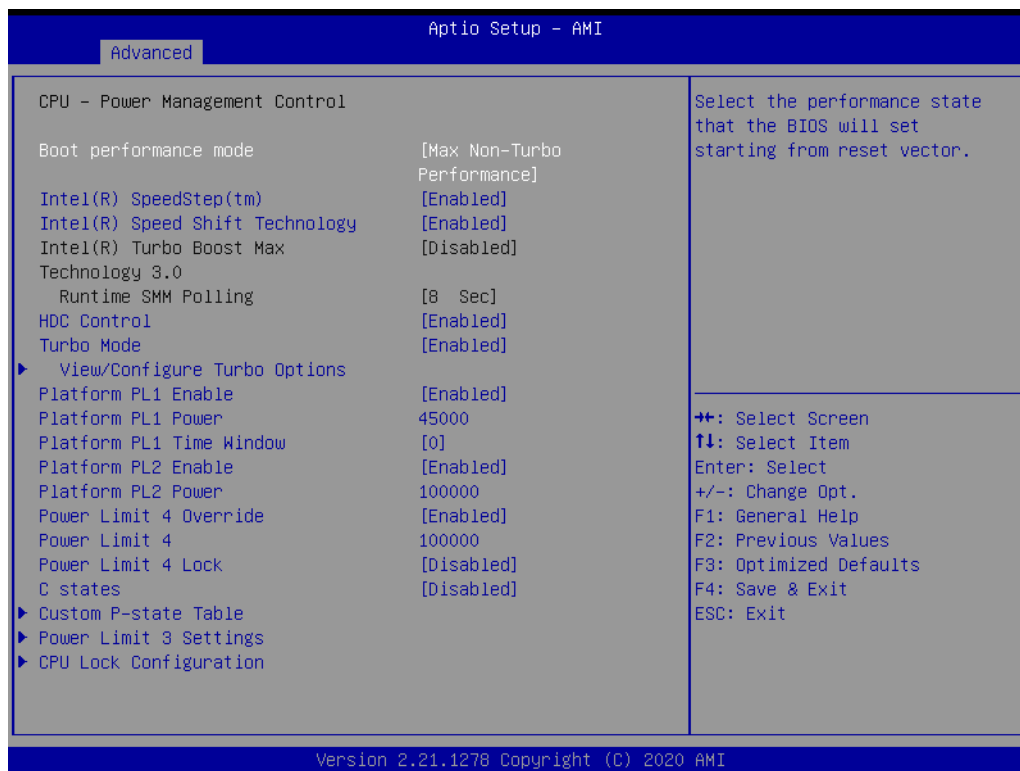

- **Boot Performance**  
Select the performance state that the BIOS will set before OS hand-off.
- **Intel® Speedstep™**  
Allows more than two frequency ranges to be supported.
- **Intel® Speed Shift Technology**  
Enable/Disable Intel® Speed Shift Technology support. Enabling will expose the CPPC v2 interface to allow for hardware controlled P-states.
- **HDC Control**  
This option allows HDC configuration.
- **Turbo Mode**  
Enable/Disable processor Turbo Mode (requires Intel Speed Step or Intel Speed Shift to be available and enabled).
- **Platform PL1 Enable**  
Enable/Disable Platform Power Limit 1 programming.
- **Platform PL1 Power**  
Platform Power Limit 1 Power in Milli Watts.
- **Platform PL1 Time Window**  
Platform Power Limit 1 Time Window value in seconds.
- **Platform PL2 Enable**  
Enable/Disable Platform Power Limit 2 programming.
- **Platform PL2 Power**  
Platform Power Limit 2 Power in Milli Watts.
- **Power Limit 4 Override**  
Enable/Disable Power Limit 4 override.
- **Power Limit 4**  
Power Limit 4 in Milli Watts.
- **Power Limit 4 Lock**

Power Limit 4 MSR 601h Lock. When enabled PL4 configurations are locked during OS. When disabled PL4 configuration can be changed during OS.

■ **C states**

Enable/Disable CPU Power Management.

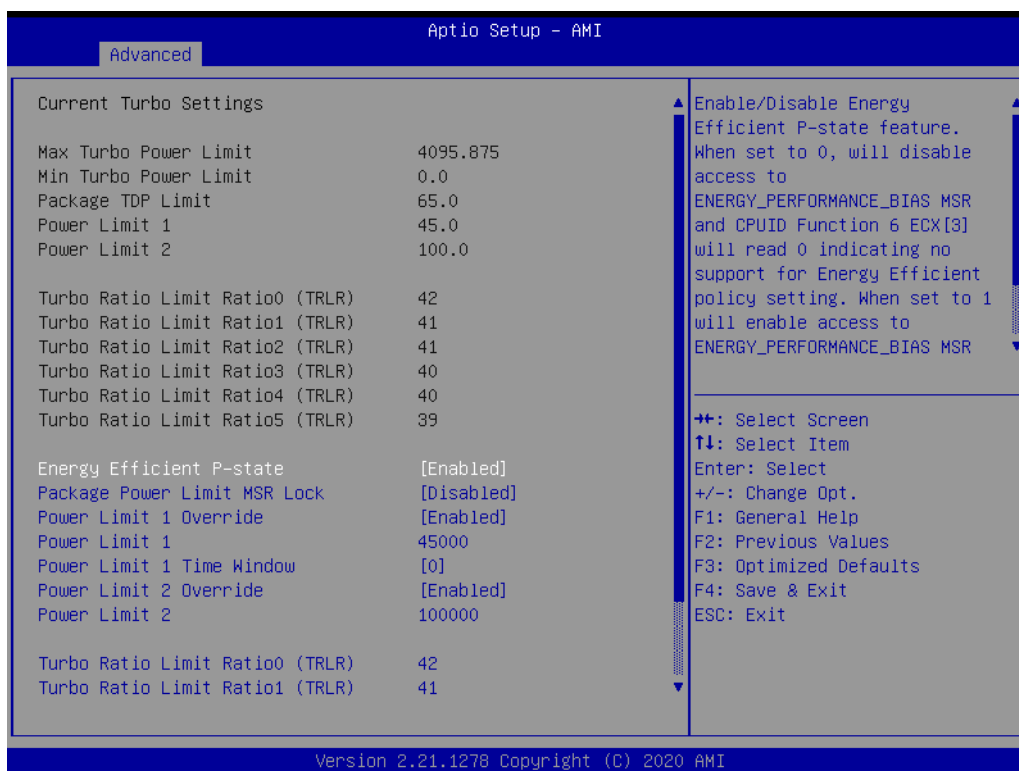
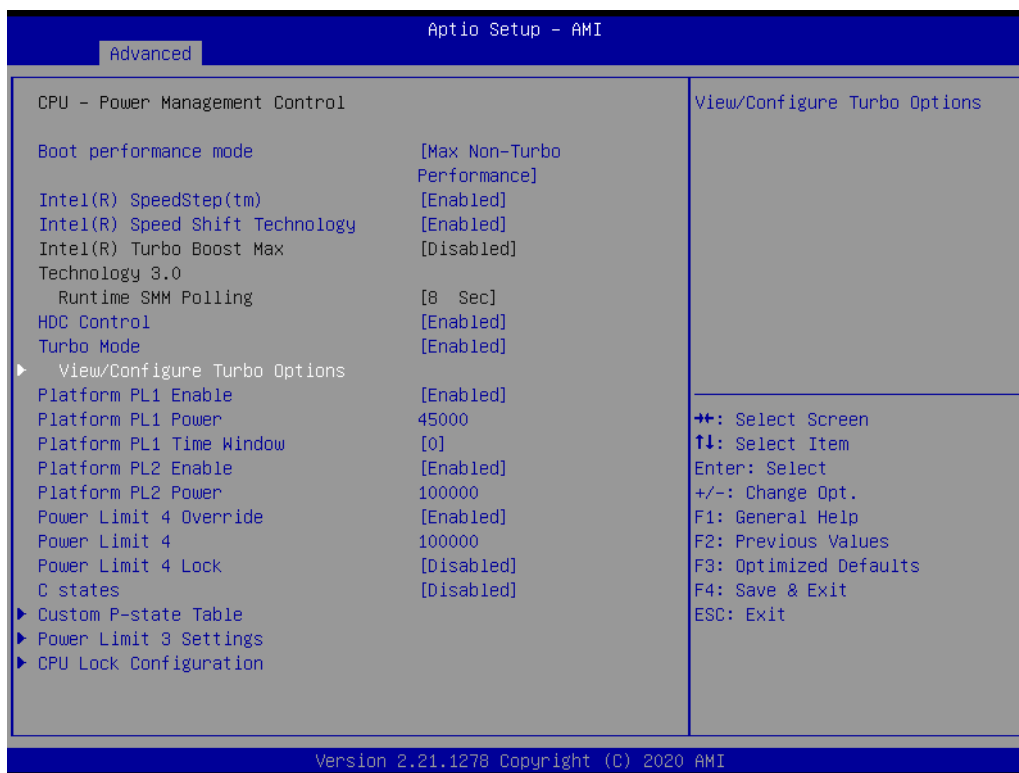

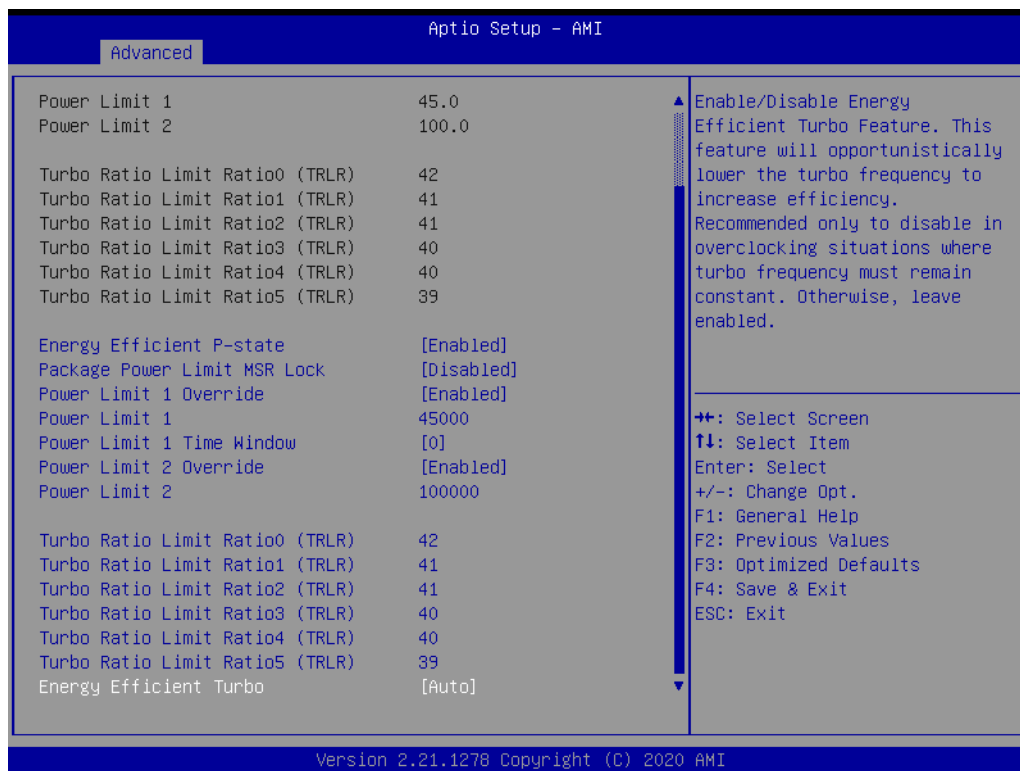

- Energy Efficient P-state  
Enable/Disable Energy Efficient P-state feature.
- Package Power Limit MSR Lock  
Enable/Disable locking of Package Power Limit settings.
- Power Limit 1 Override  
Enable/Disable Power Limit 1 override.
- Power Limit 1  
Power Limit 1 in Milli Watts.
- Power Limit 1 Time Window  
Power Limit 1 Time Window value in seconds.
- Power Limit 2 Override  
Enable/Disable Power Limit 2 override.
- Power Limit 2  
Power Limit 2 value in Milli Watts.
- Turbo Ratio Limit Ratio 0~5 (TRLR)  
Turbo Ratio Limit Ratio 0~5 (TRLR) with range of (Max Non-Turbo Ratio - 255). Min = Max Non-Turbo Ratio. Max = fused turbo ratio, or 255 if CPU is unlocked for overclocking.
- Energy Efficient Turbo  
Enable/Disable Energy Efficient Turbo Feature. This feature will opportunistically lower the turbo frequency to increase efficiency.

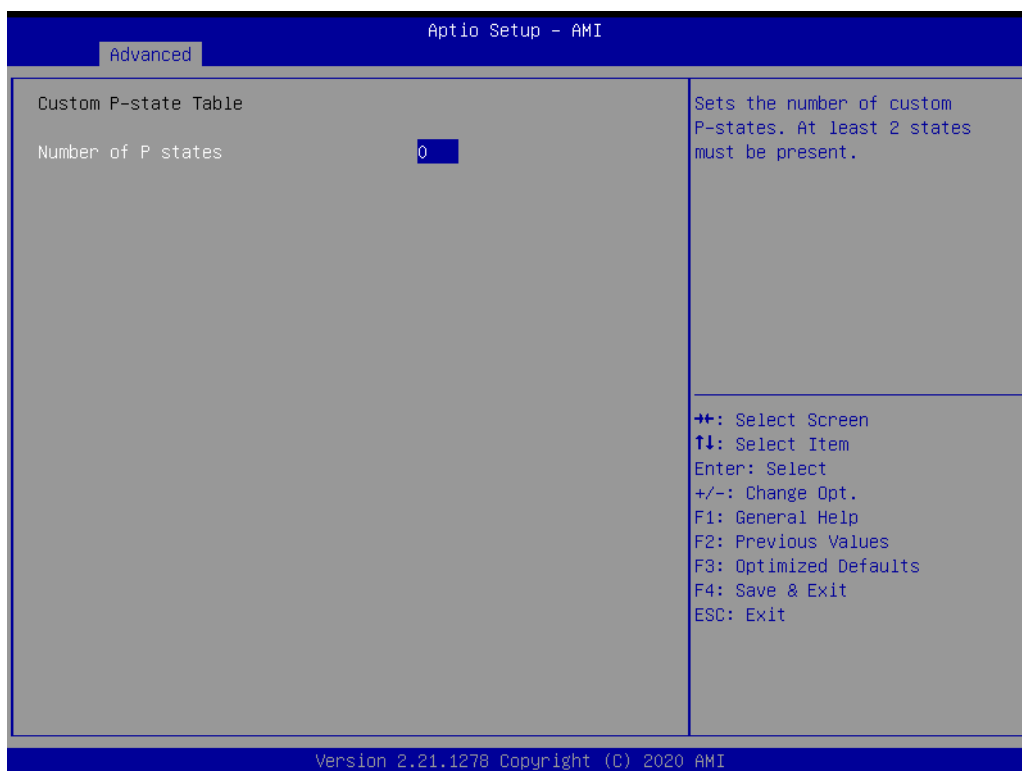
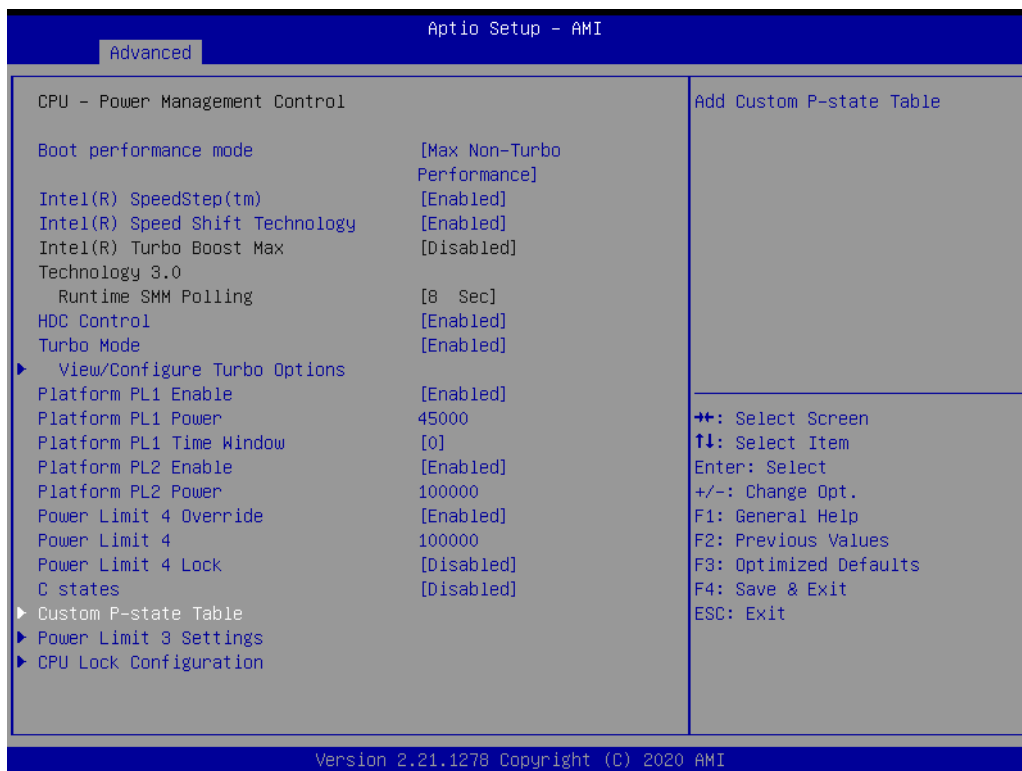

- Number of P states  
Sets the number of custom P-states. At least 2 states must be present.

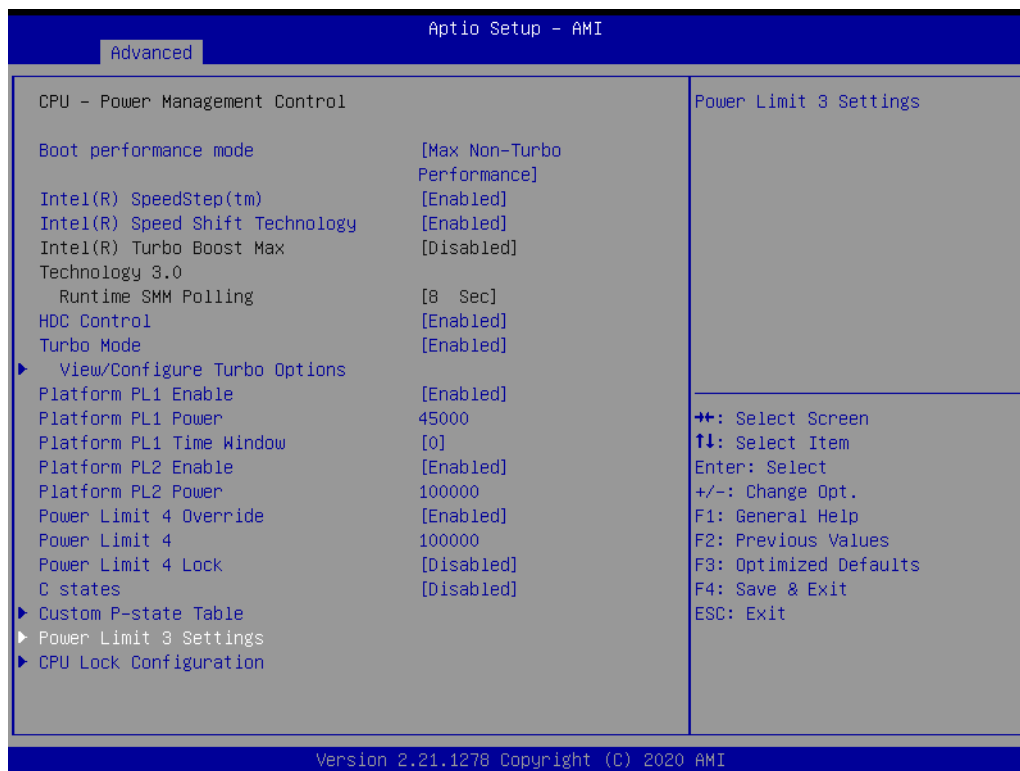

- Power Limit 3 Override  
Enable/Disable Power Limit 3 override.
- Power Limit 3  
Power Limit 3 in Milli Watts.
- Power Limit 3 Time Window  
Power Limit 3 Time Window value in Milli seconds.

- Power Limit 3 Duty Cycle  
Specify the duty cycle in percentage that the CPU is required to maintain over the configured time window. Range is 0-100.
- Power Limit 3 Lock  
Power Limit 3 MSR 615h Lock. When enabled PL3 configurations are locked during OS. When disabled PL3 configuration can be changed during OS.

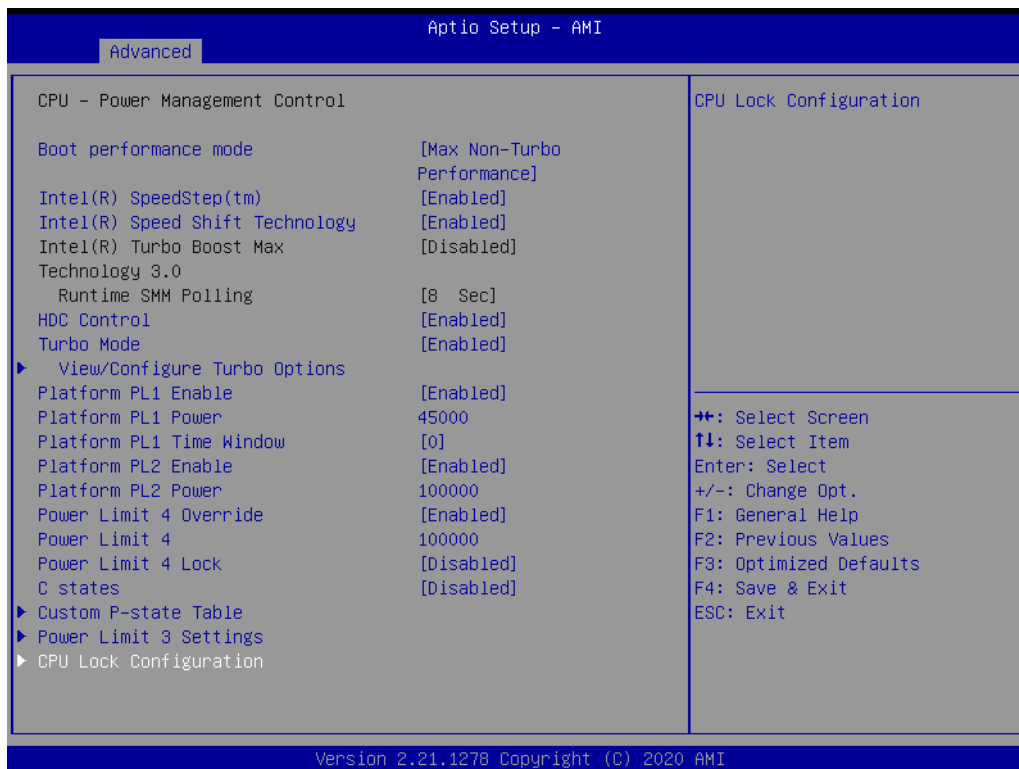

- CFG Lock  
Configure MSR 0xE2[15], CFG Lock bit.
- Overclocking Lock  
Enable/Disable Overclocking Lock (BIT 20) in FLEX\_RATIO(194) MSR.



- RC6 (Render Standby)  
Check to enable render standby support.



- Maximum GT frequency  
Maximum GT frequency limited by the user.
- Disable Turbo GT frequency  
Enabled: Disables Turbo GT frequency. Disabled: GT frequency is not limited.

### 3.2.2.4 PCH-FW Configuration

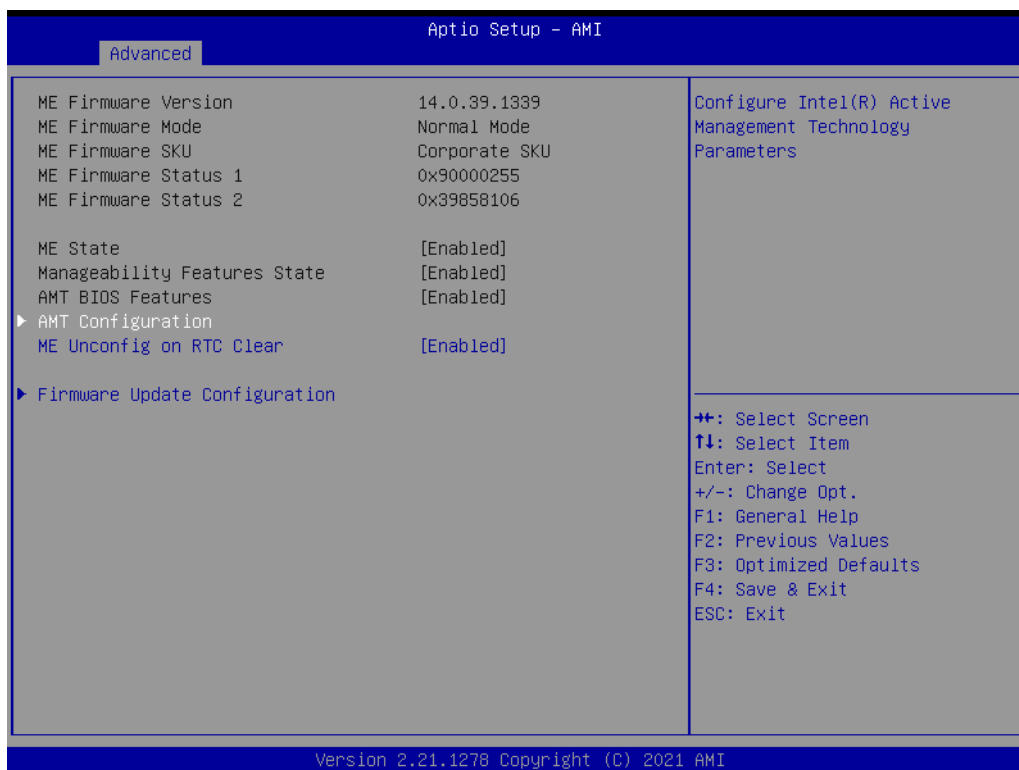
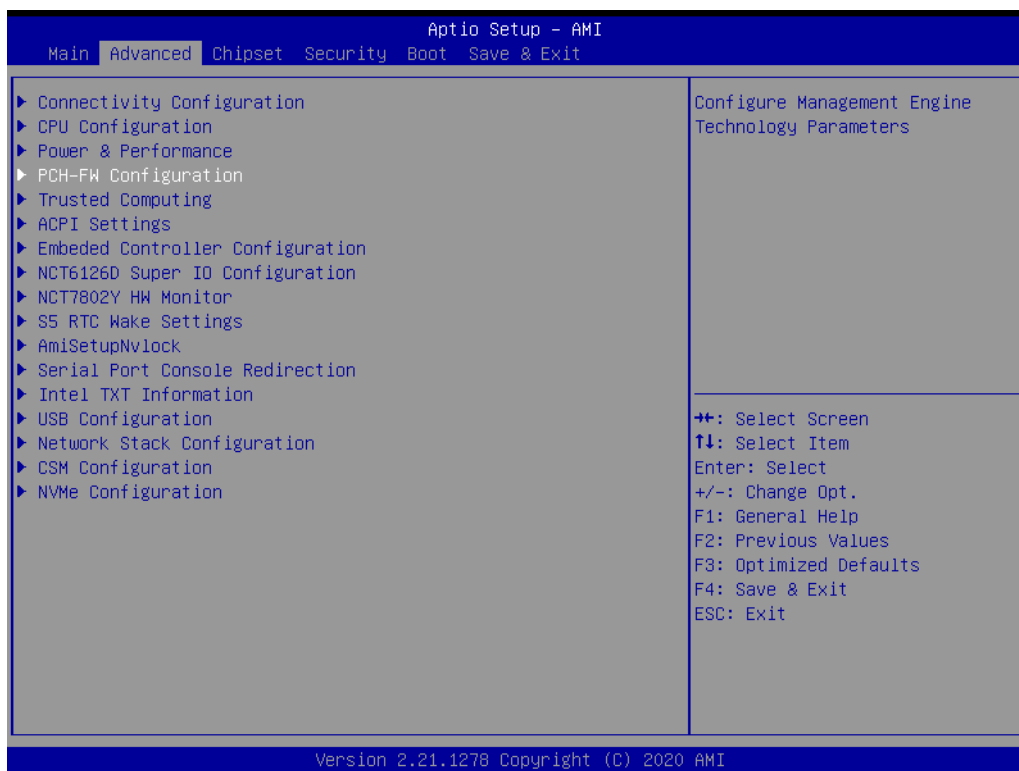

- **ME State**  
When Disabled ME will be put into ME Temporarily Disabled Mode.
- **Manageability Features State**  
Enable/Disable Intel Manageability features.
- **AMT BIOS Features**  
When disabled AMT BIOS Features are no longer supported and user is no longer able to access MEBx Setup.
- **ME Unconfig on RTC Clear**  
When Disabled ME will not be unconfigured on RTC Clear.

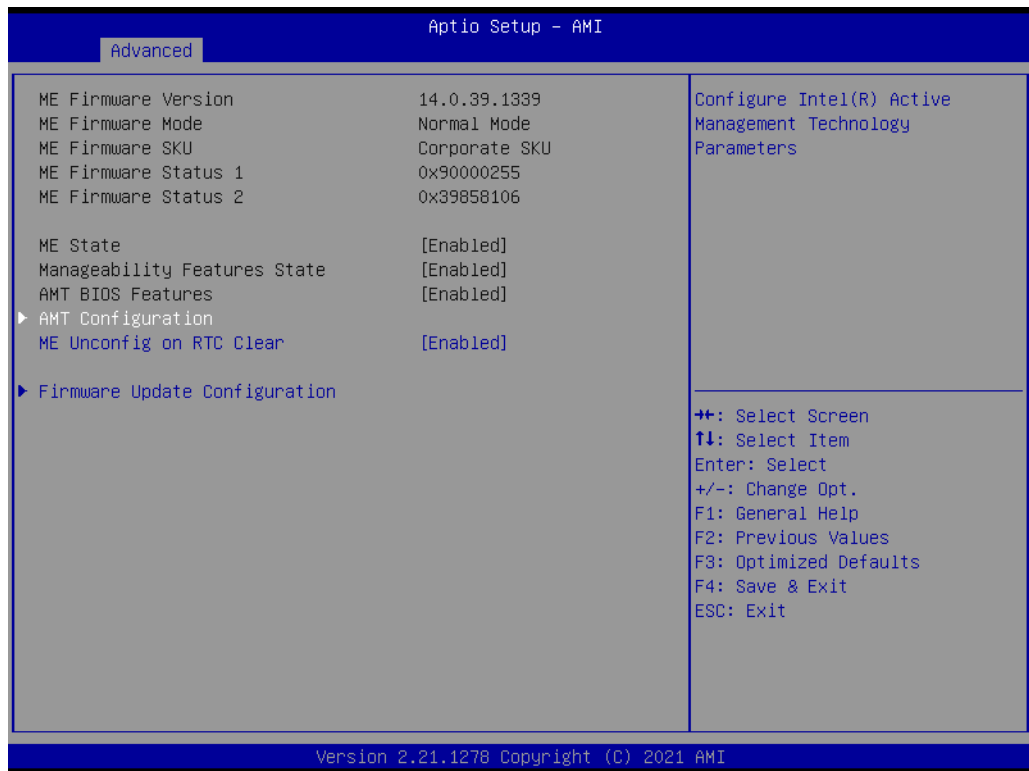

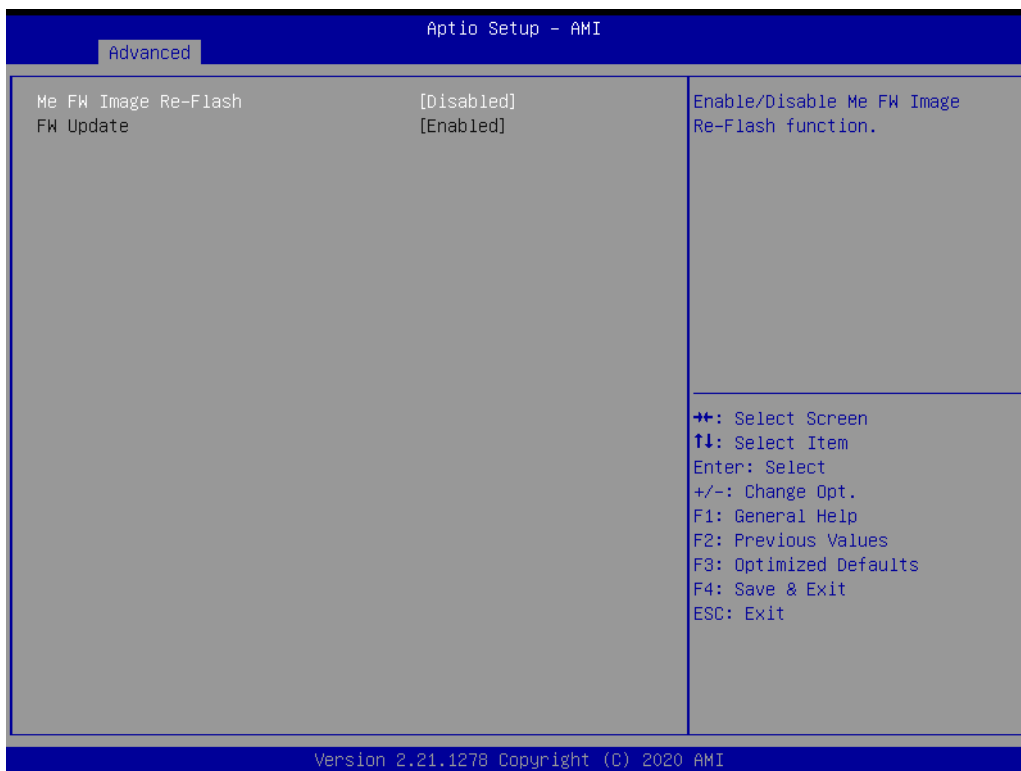

- Me FW Image Re-Flash  
Enable/Disable Me FW Image Re-Flash function.
- FW Update  
Enable/Disable ME FW Update function.

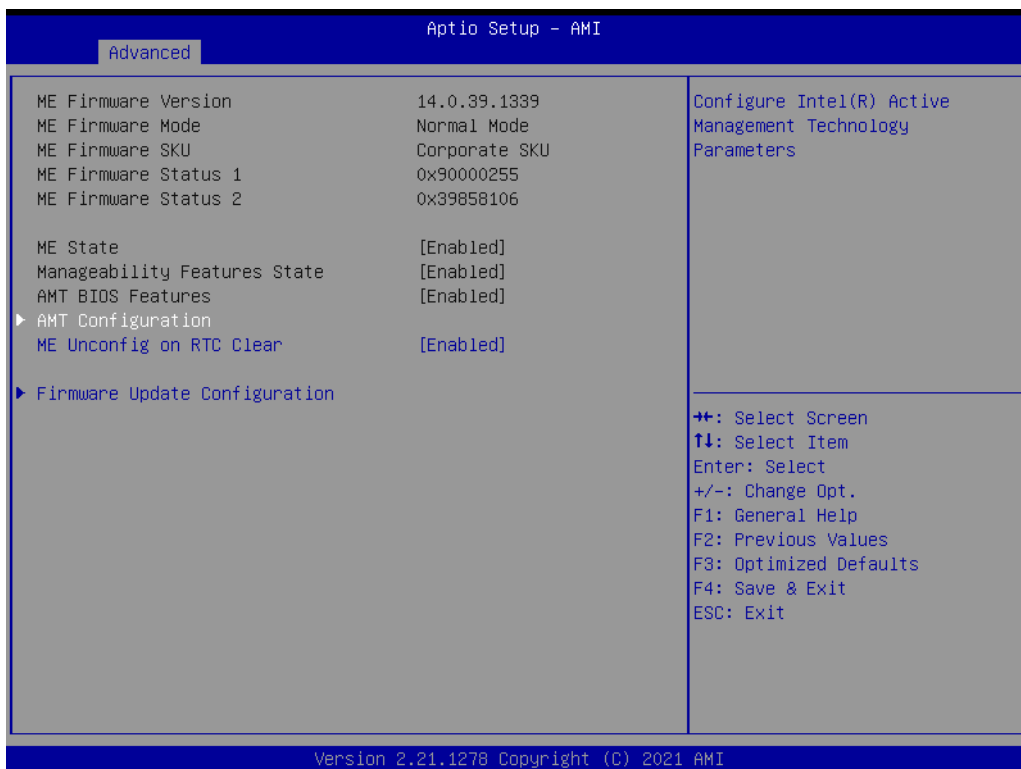

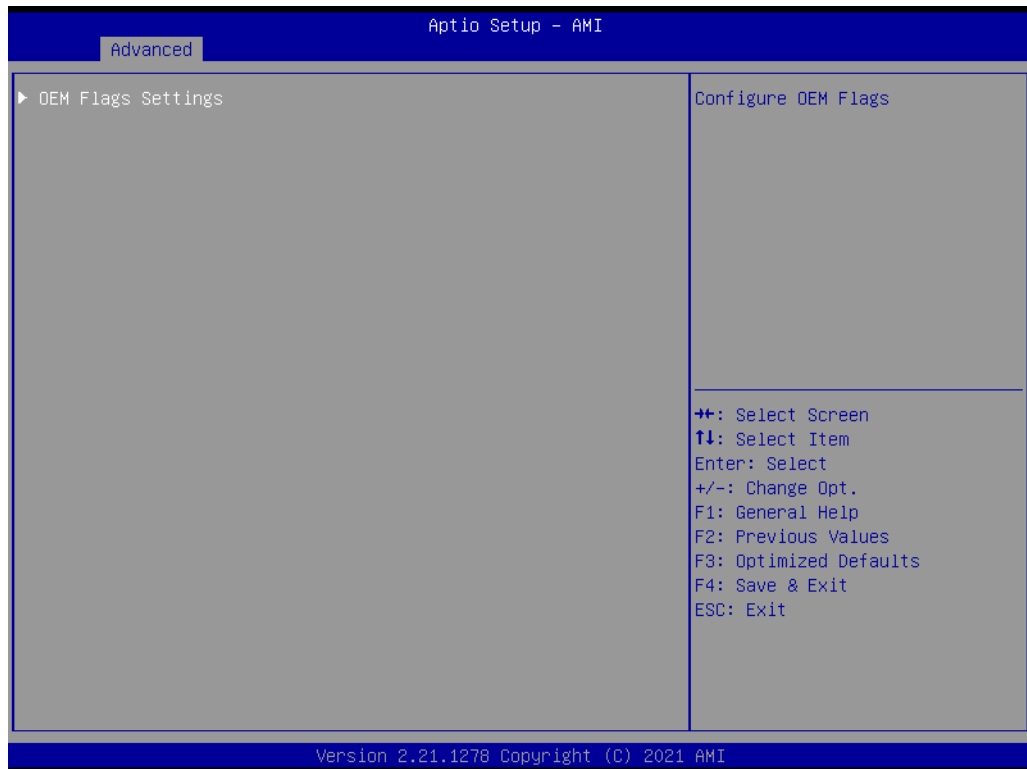

- MEBx hotkey Pressed  
Enable automatic MEBx hotkey press.
- MEBx Selection Screen  
Enable MEBx selection screen.
- Hide Unconfigure ME Confirmation Prompt  
Hide Unconfigure ME confirmation prompt when attempting ME unconfiguration.

- MEBx OEM Debug Menu Enable  
Enable OEM debug menu in MEBx.
- Unconfigure ME  
Unconfigure ME with resetting MEBx password to default.

### 3.2.2.5 Trusted Computing

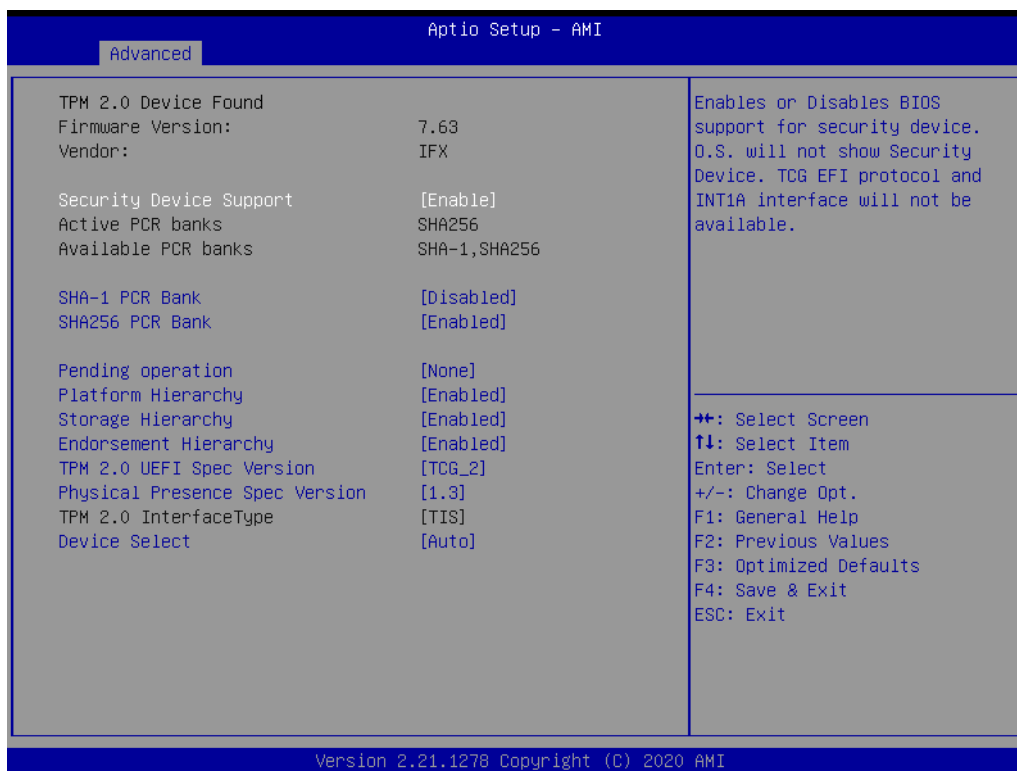

- **Security Device Support**  
Enables or Disables BIOS support for security device.
- **SHA-1 PCR Bank**  
Enable or Disable SHA-1 PCR Bank.
- **SHA256 PCR Bank**  
Enable or Disable SHA256 PCR Bank.
- **Pending Operation**  
Schedule an Operation for the Security Device.
- **Platform Hierarchy**  
Enable or Disable Platform Hierarchy.
- **Storage Hierarchy**  
Enable or Disable Storage Hierarchy.
- **Endorsement Hierarchy**  
Enable or Disable Endorsement Hierarchy.
- **TPM 2.0 InterfaceType**  
Select the TCG2 Spec Version Support.
- **Physical Presence Spec Version**  
Select to Tell O.S. to support PPI Spec Version 1.2 or 1.3.
- **TPM 2.0 InterfaceType**  
Select the Communication Interface to TPM 20 Device.
- **Device Select**  
TPM 1.2 will restrict support to TPM 1.2 devices, TPM 2.0 will restrict support to TPM 2.0 devices, Auto will support both with the default set to TPM 2.0 devices if not found, TPM 1.2 devices will be enumerated.

### 3.2.2.6 ACPI Settings

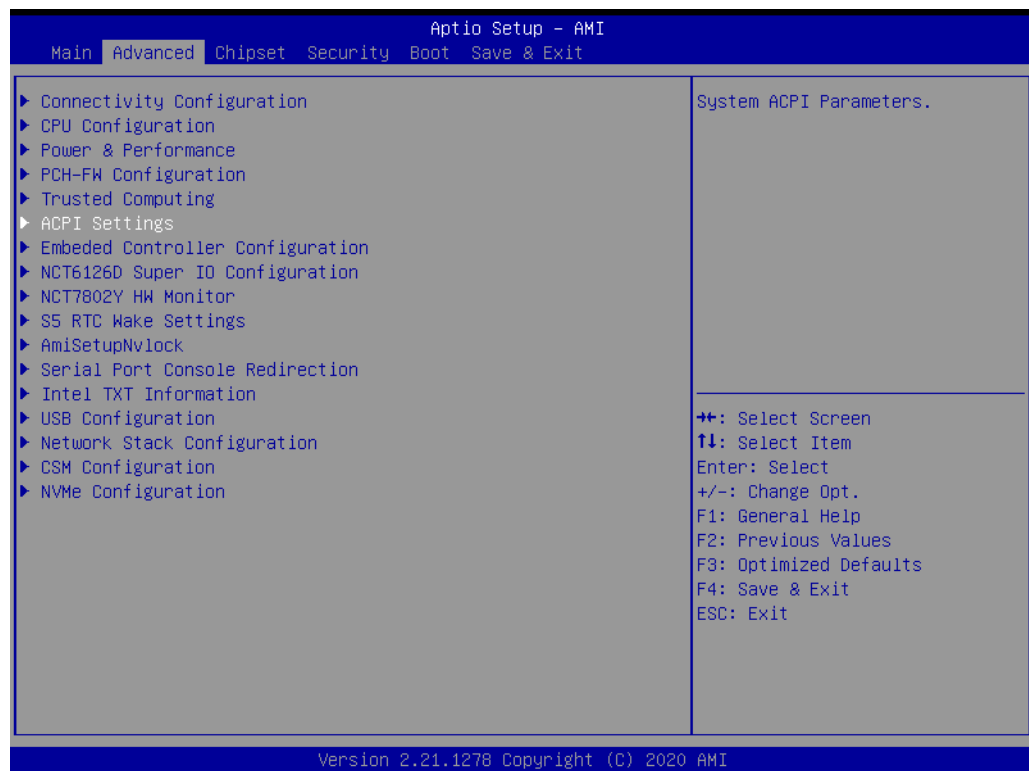

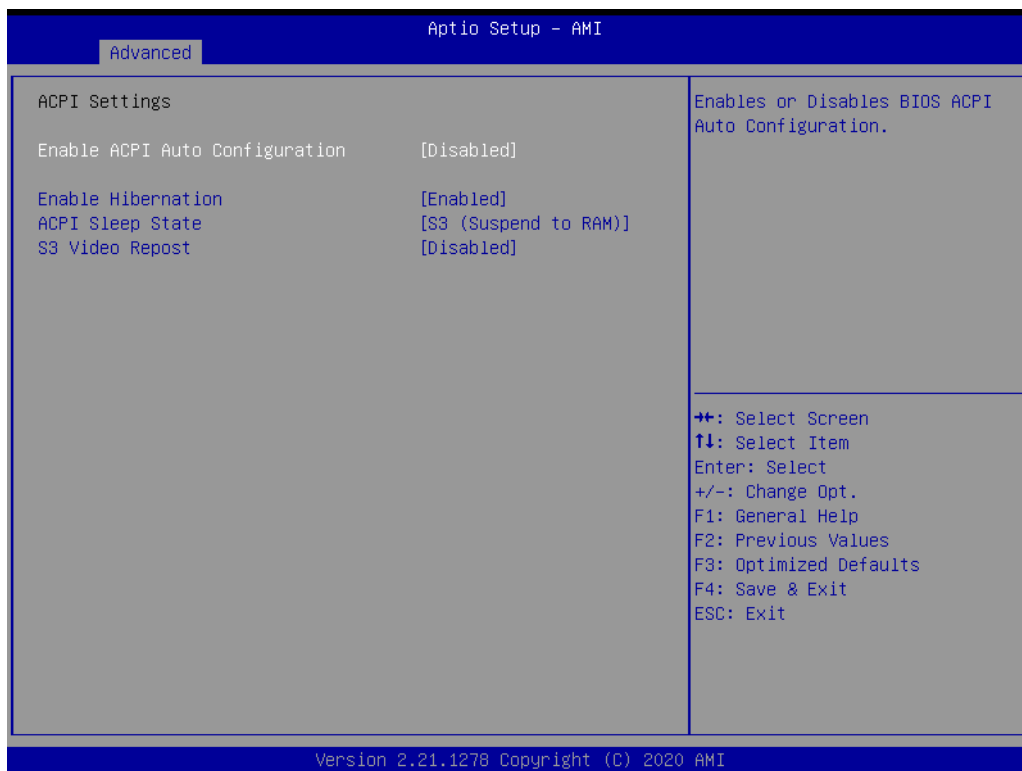

- **Enable ACPI Auto Configuration**  
Enables or Disables BIOS ACPI Auto Configuration.
- **Enable Hibernation**  
Enables or Disables System's ability to Hibernate (OS/S4 Sleep State).
- **ACPI Sleep State**  
Select the highest ACPI sleep state the system will enter when the SUSPEND button is pressed.
- **S3 Video Repost**  
Enable or Disable S3 Video Repost

### 3.2.2.7 Embedded Controller Configuration

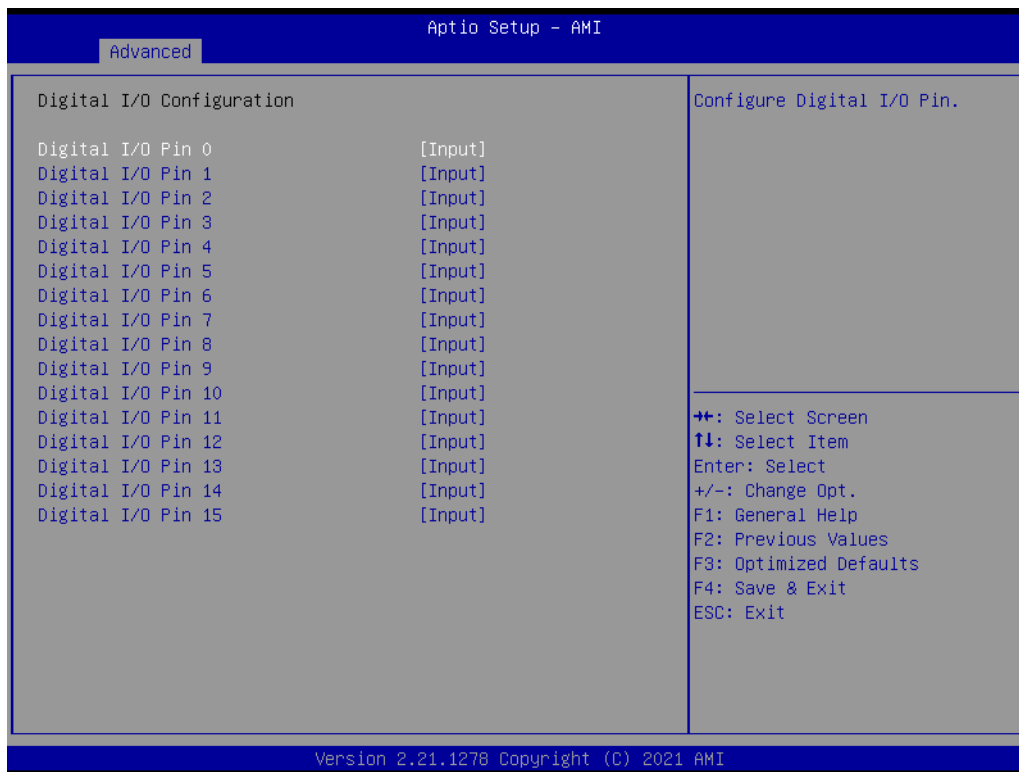
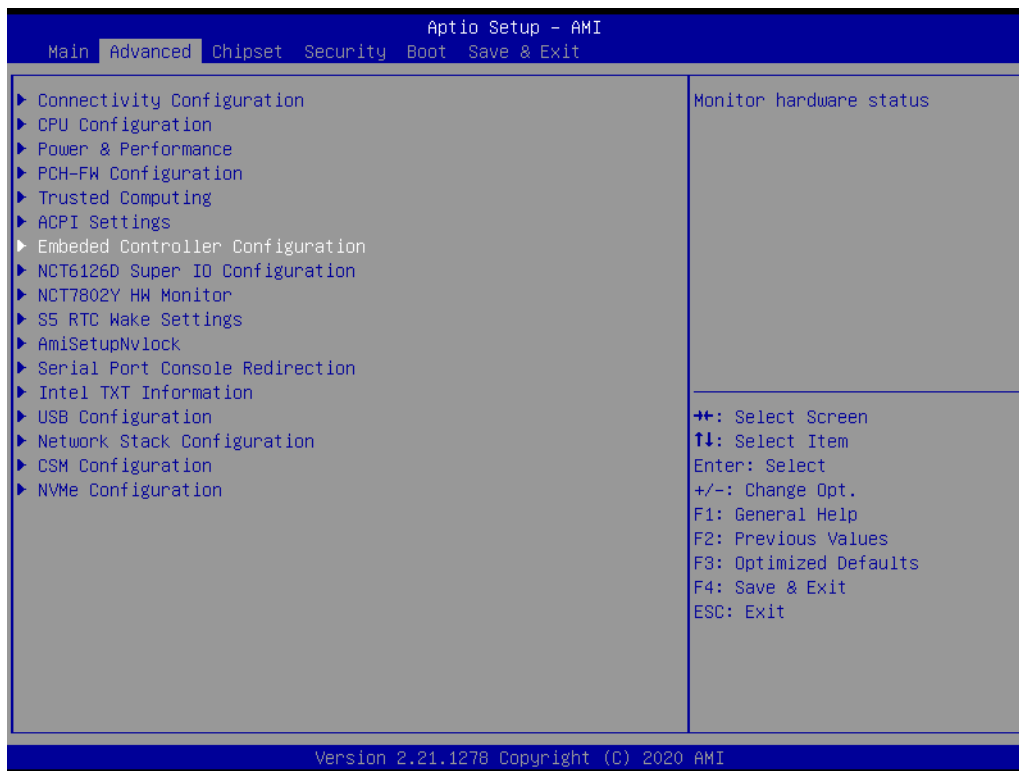

- **Power Saving Mode**  
Select Power Saving Mode
- **Deep Sleep delay time**  
Set delay time for Deep Sleep mode.
- **Watchdog Timer**  
Enabled or Disabled Watchdog Timer. (Start before boot to OS and must stop by self)



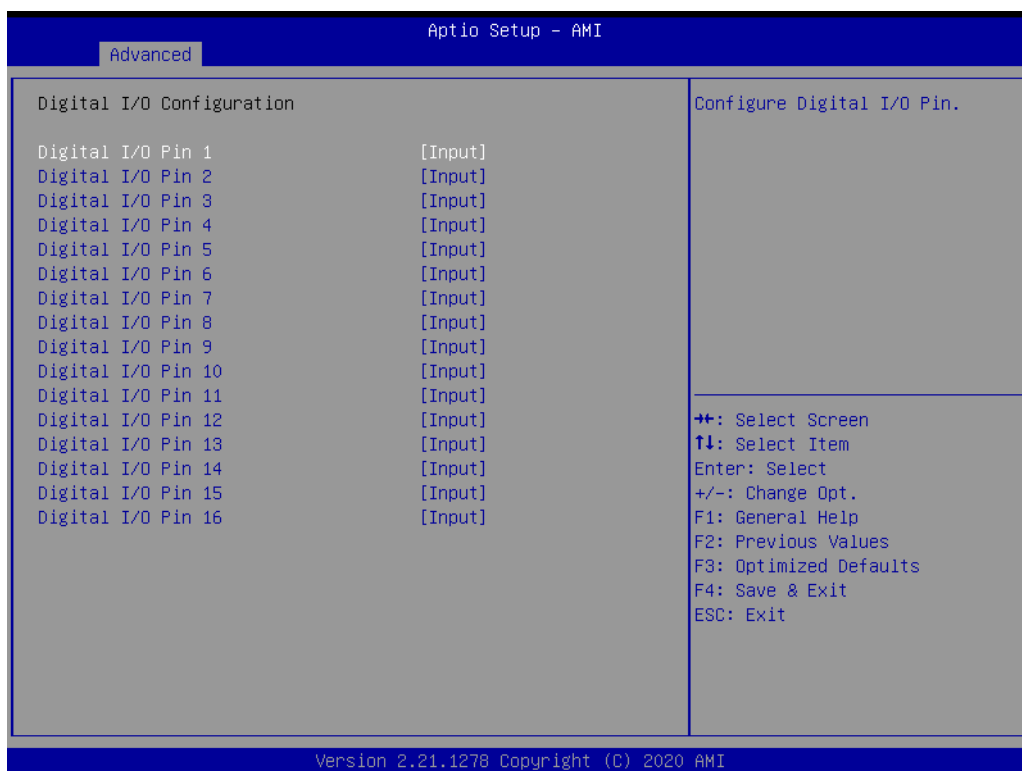
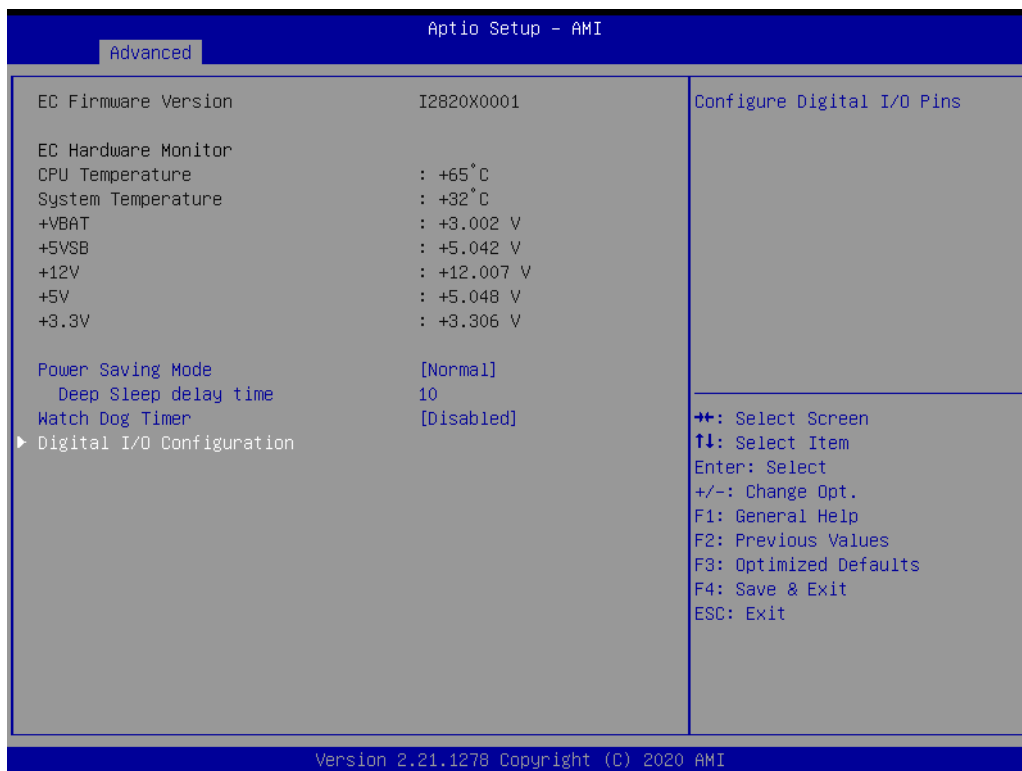

- Digital I/O Pin 1~16  
Configure Digital I/O Pin.

### 3.2.2.8 NCT61260 Super I/O Configuration

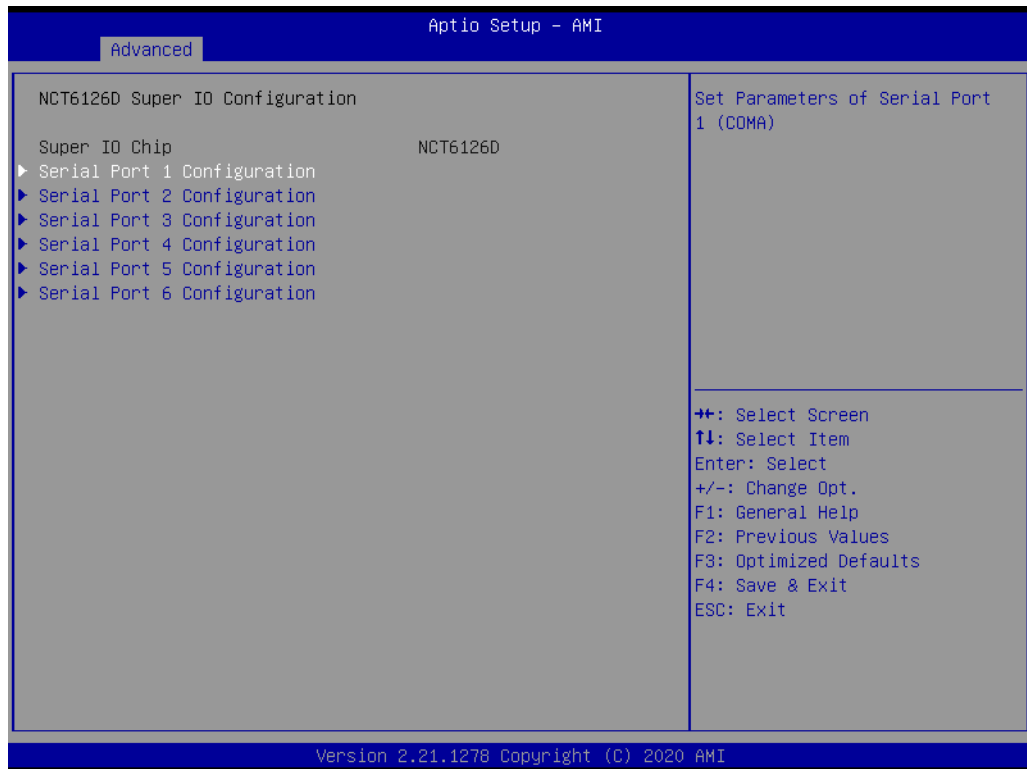
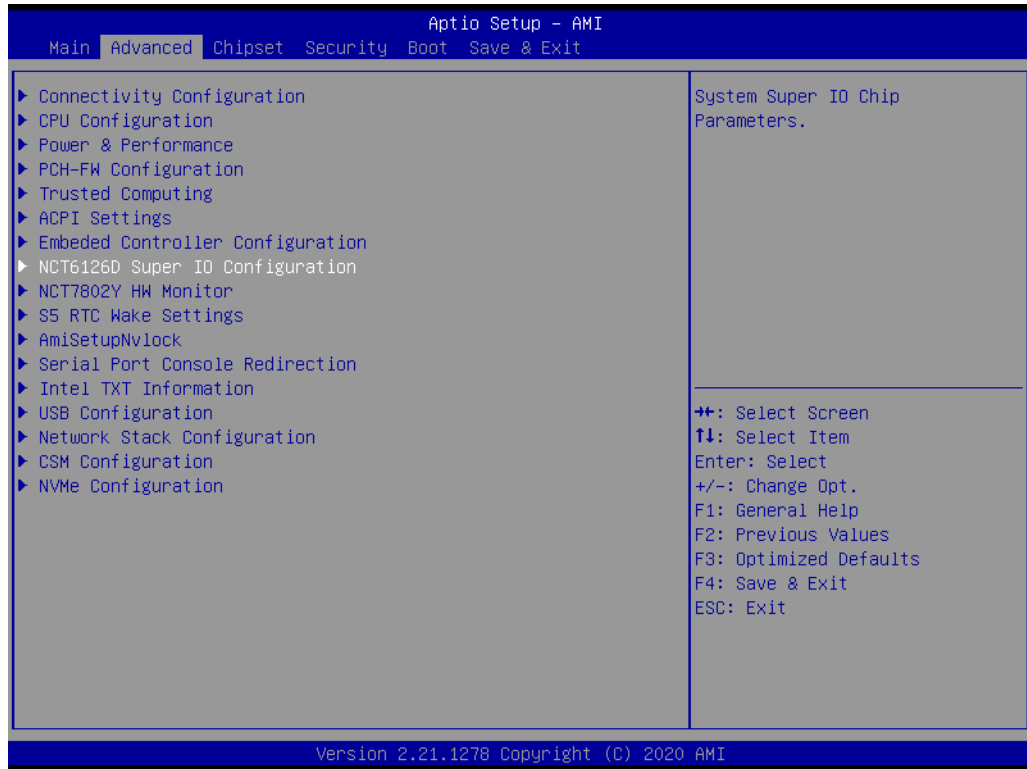

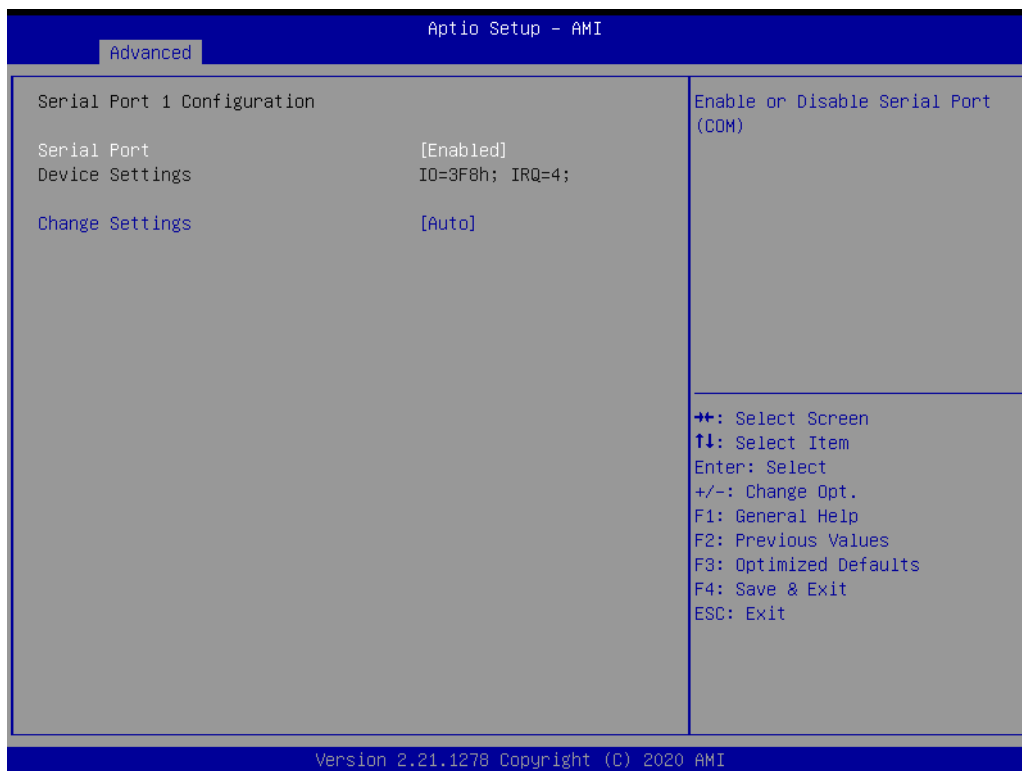

- Serial Port
  - Enable or Disable Serial Port
- Change Settings
  - Select an optimal settings for super IO Device.
- COM3~6 Mode
  - COM Mode Select.

### 3.2.2.9 NCT7802Y HW Monitor

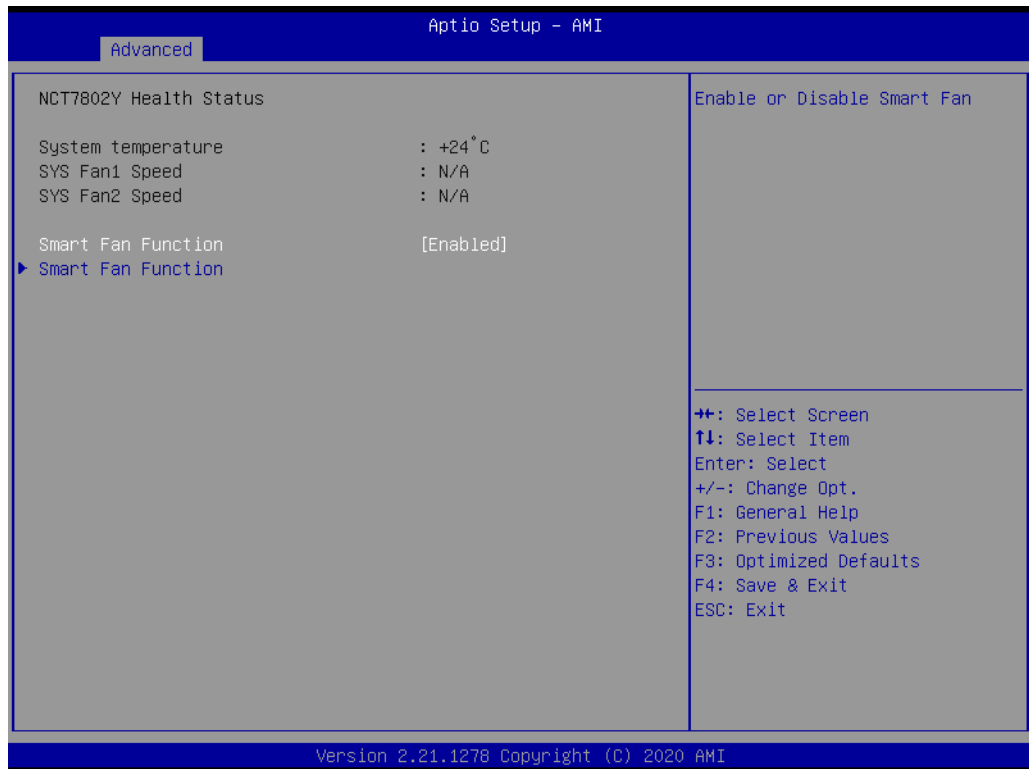
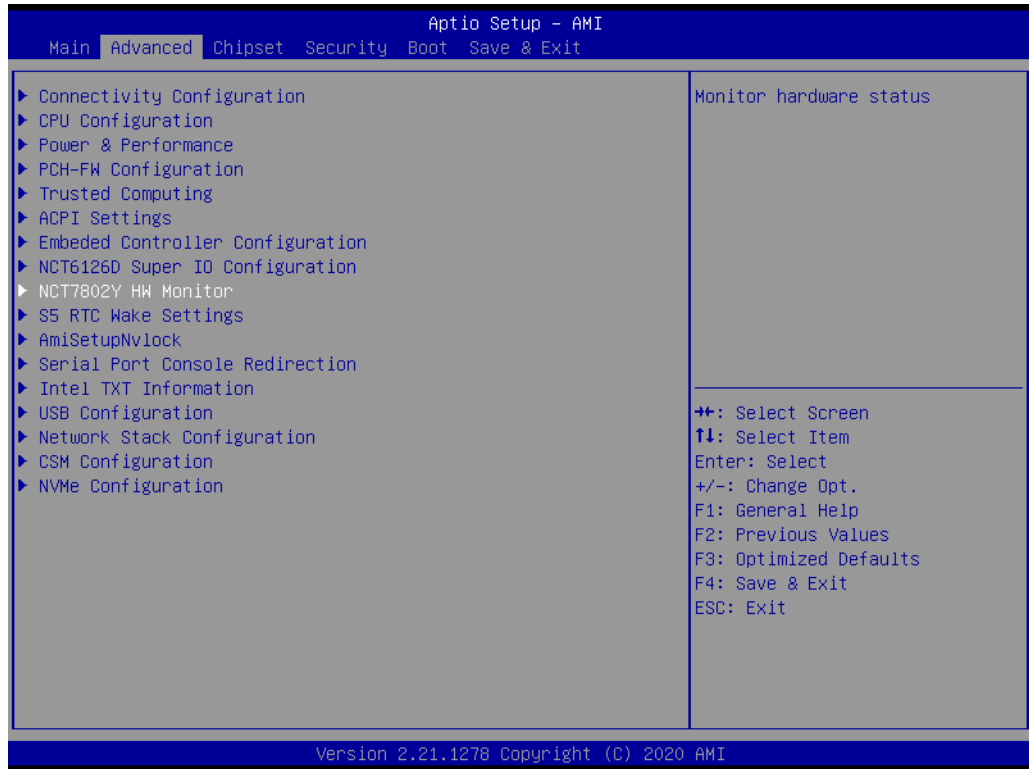

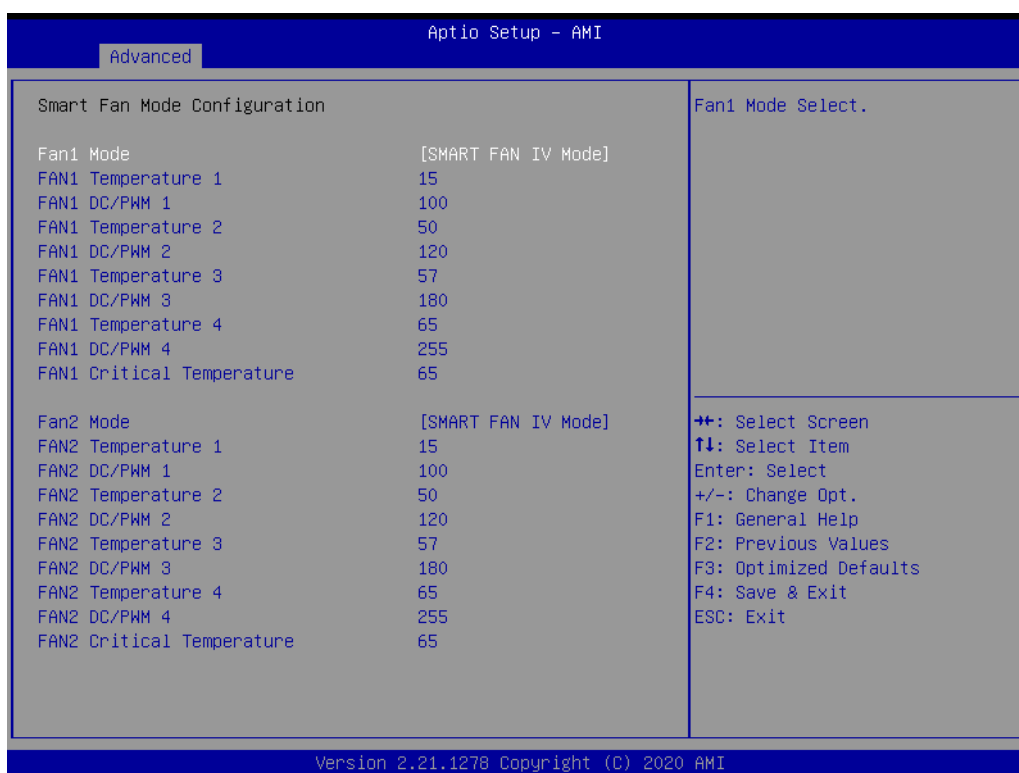

- **Smart Fan Function**  
Enable or Disable Smart Fan.
- **Fan Mode**  
Fan Mode Select.
- **FAN Temperature 1**  
Input the System Smart Fan IV Temperature 1.

- **FAN DC/PWM 1**  
Input the System Smart Fan IV DC/PWM 1 Value.
- **FAN Temperature 2**  
Input the System Smart Fan IV Temperature 2.
- **FAN DC/PWM 2**  
Input the System Smart Fan IV DC/PWM 2 Value.
- **FAN Temperature 3**  
Input the System Smart Fan IV Temperature 3.
- **FAN DC/PWM 3**  
Input the System Smart Fan IV DC/PWM 3 Value.
- **FAN Temperature 4**  
Input the System Smart Fan IV Temperature 4.
- **FAN DC/PWM 4**  
Input the System Smart Fan IV DC/PWM 4 Value.
- **FAN Critical Temperature**  
Input the System Smart IV Critical Temperature.

### 3.2.2.10 S5 RTC Wake Settings

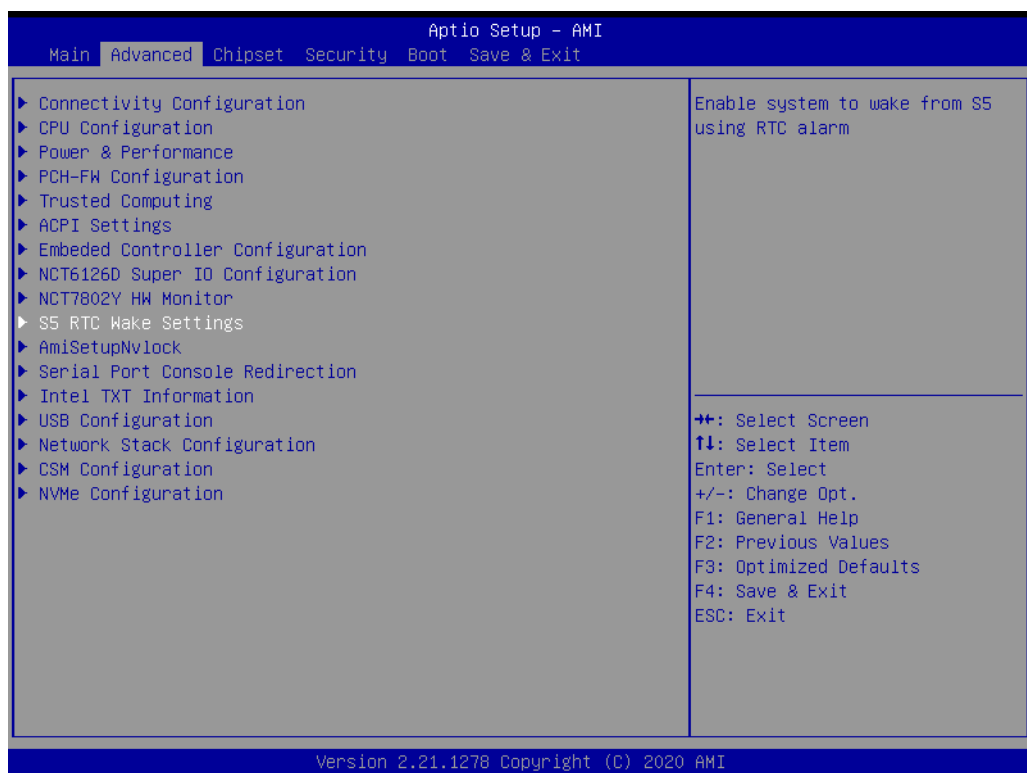

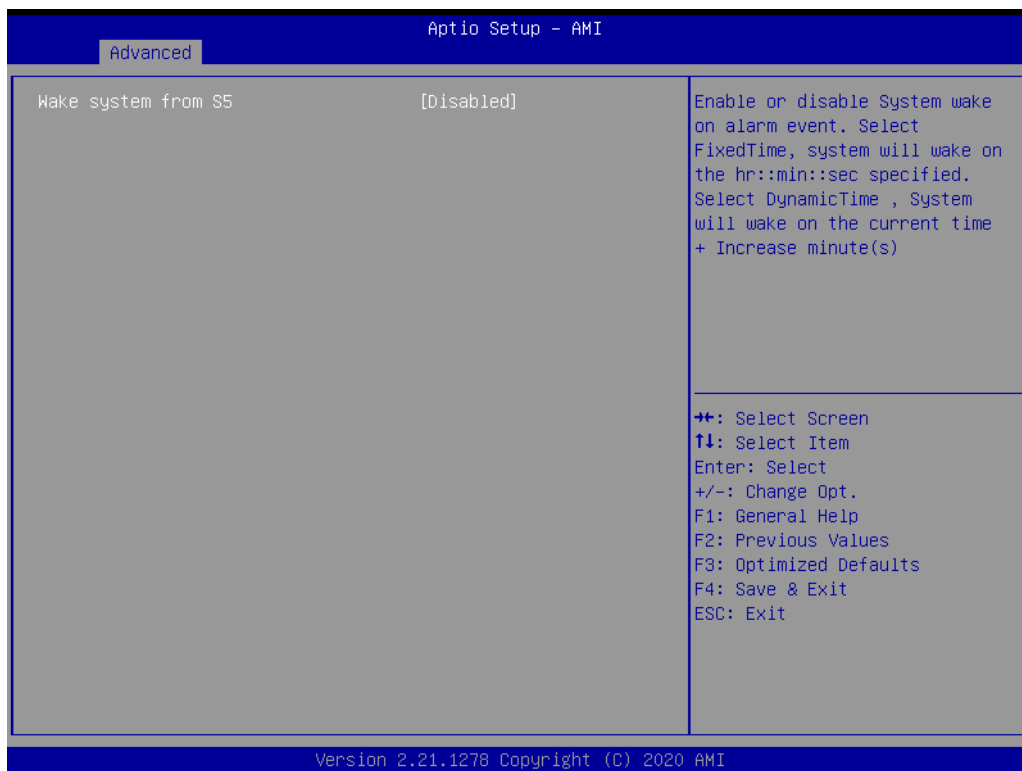

- **Wake system from S**  
Enable or disable system wake on alarm event.

### 3.2.2.11 AmiSetupNvlock

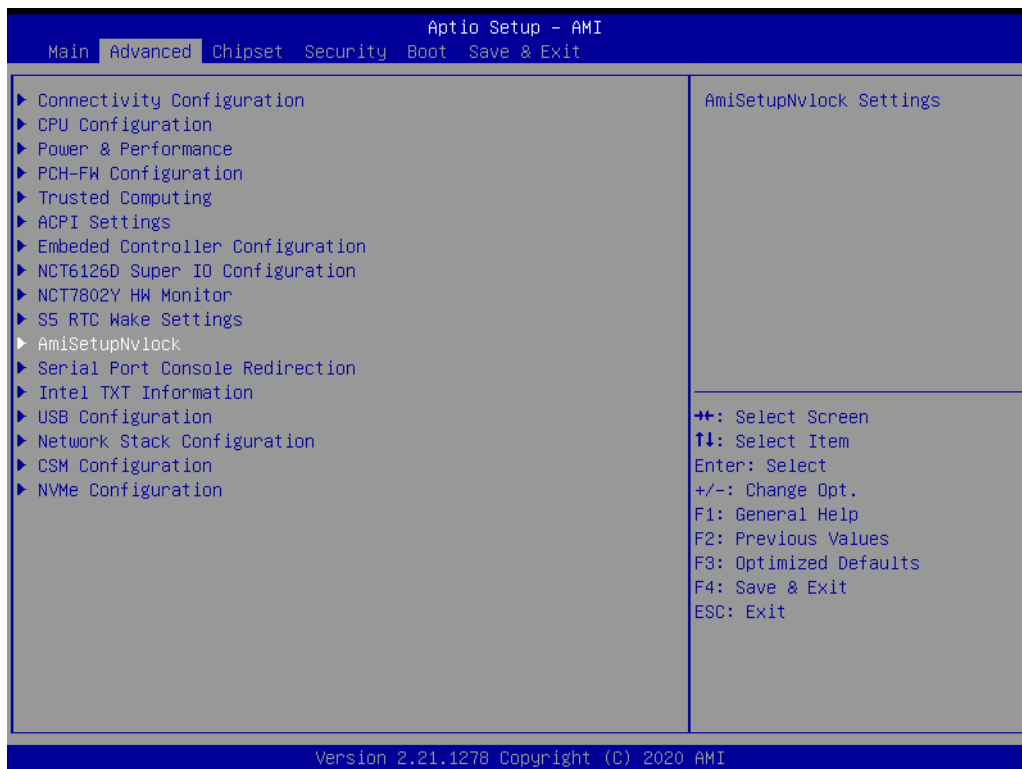



- **RunTimeVariable Protection Support**  
Enable/Disable the RunTimeVariable Protection Support.

### 3.2.2.12 Serial Port Console Redirection

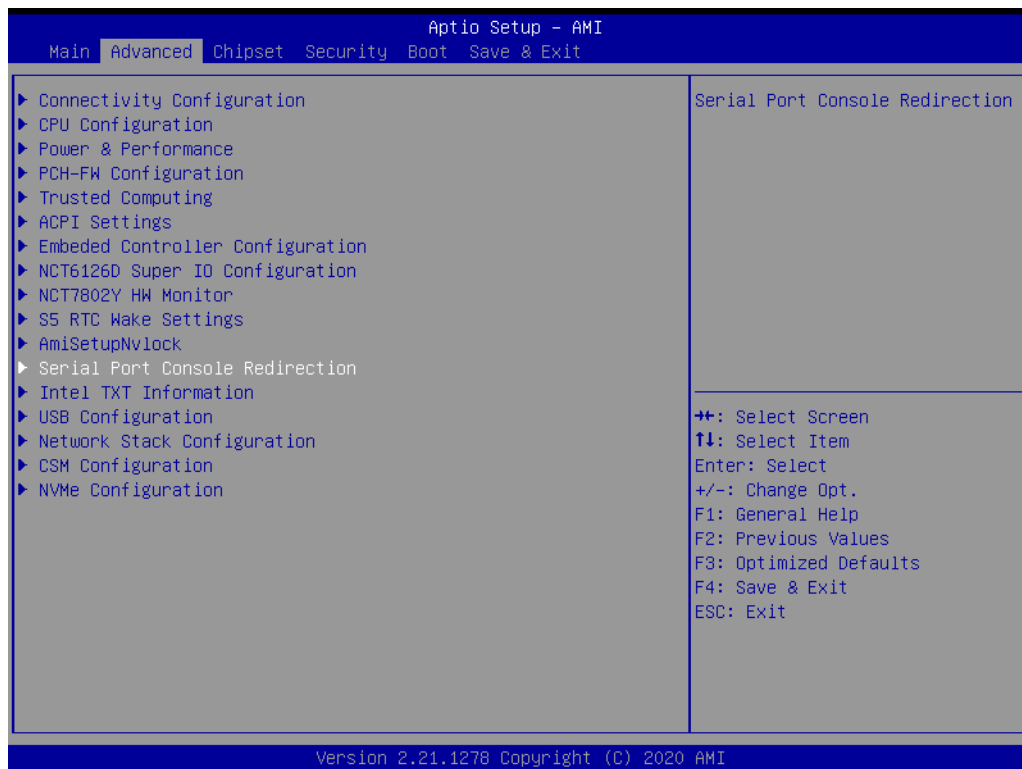





- **Console Redirection**  
Console Redirection Enable or Disable.

### 3.2.2.13 Intel TXT Information

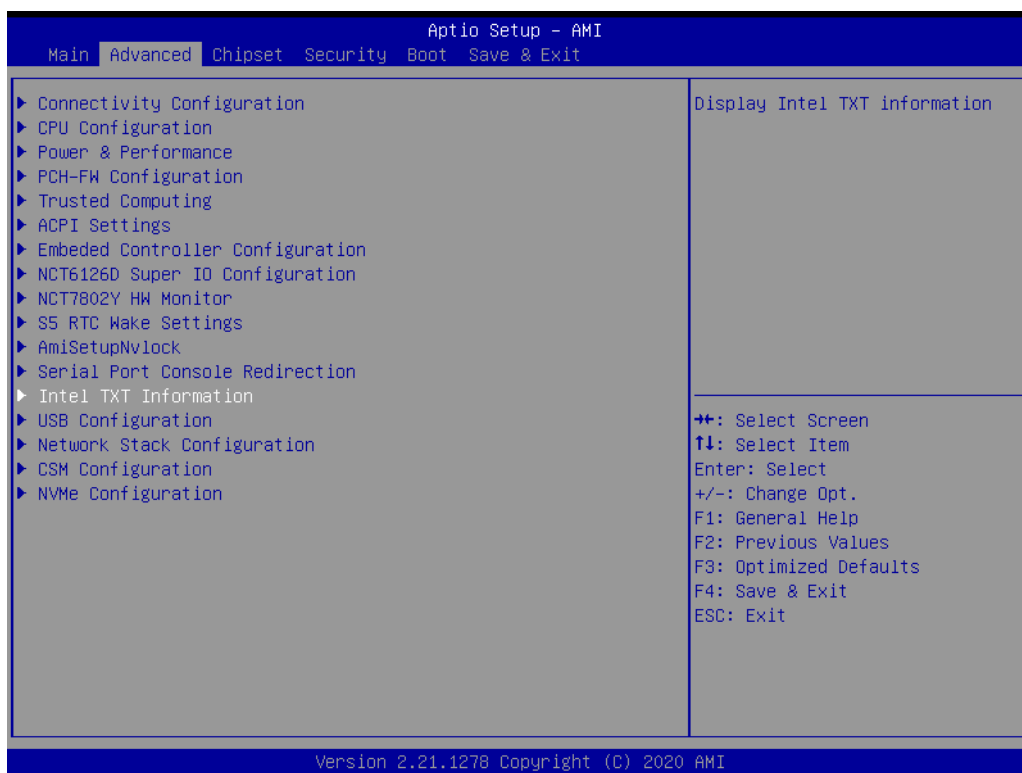



### 3.2.2.14 USB Configuration

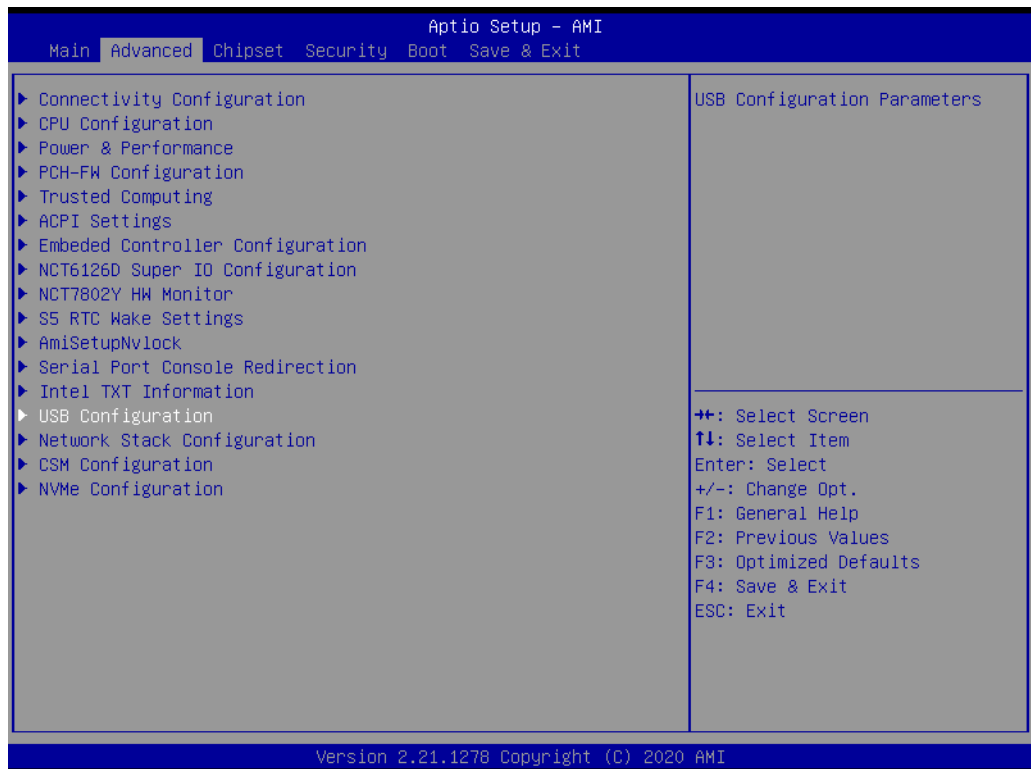

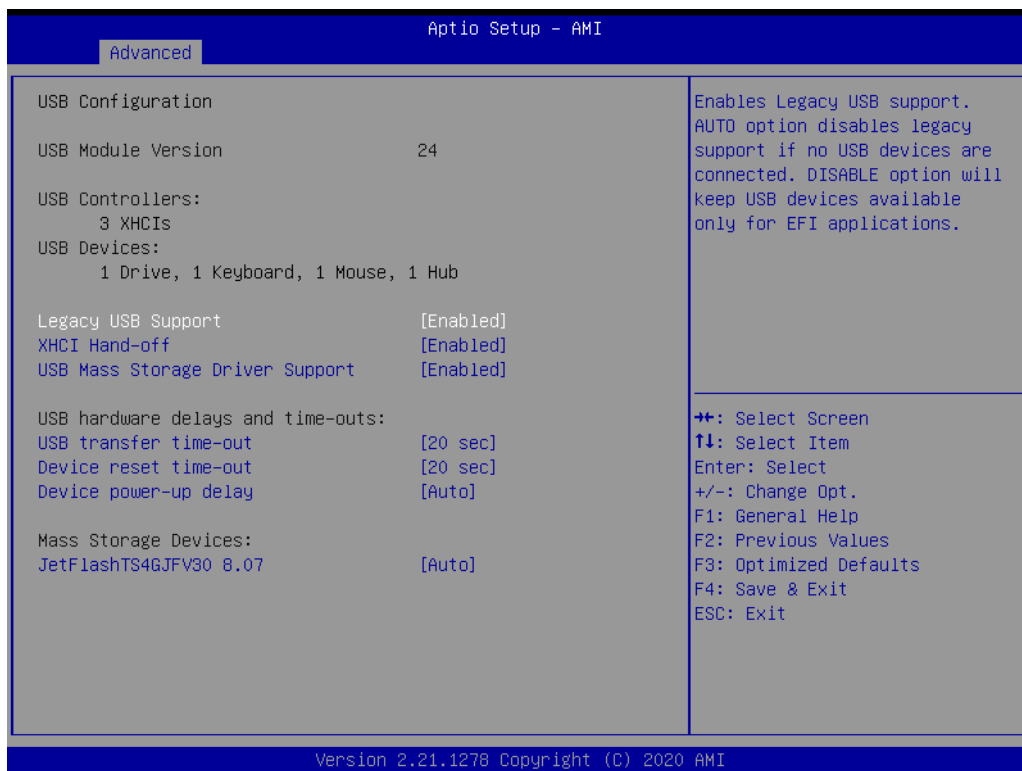

- **Legacy USB Support**  
Enables Legacy USB support.
- **XHCI Hand-off**  
This is a workaround for OSeS without XHCI hand-off support.
- **USB Mass Storage Device Configuration**  
Configure the USB Mass Storage Devices.
- **USB transfer time-out**  
The time-out value for Control, Bulk, and Interrupt transfers.
- **Device reset time-out**  
USB mass storage device Start Unit command time-out.
- **Device power-up delay**  
Maximum time the device will take before it properly reports itself to the Host Controller.

### 3.2.2.15 Network Stack Configuration

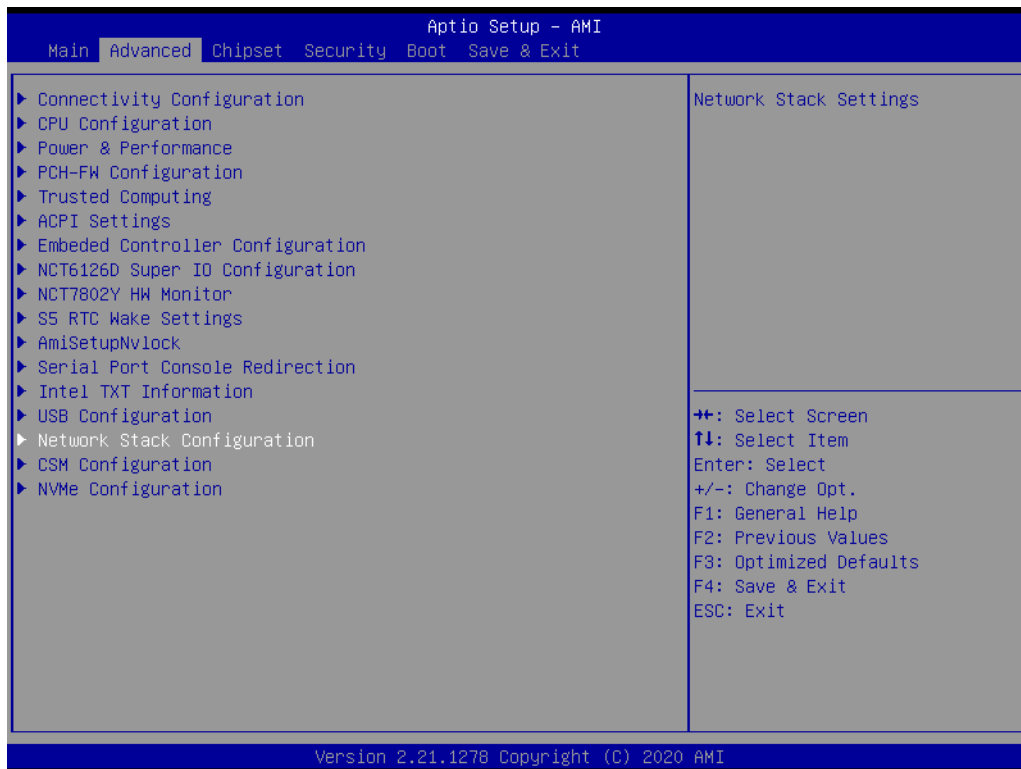

- **Network Stack**  
Enable/Disable UEFI Network Stack.
- **IPv4 PXE Support**  
Enable/Disable IPv4 PXE boot support.
- **IPv4 HTTP Support**

- Enable/Disable IPv4 HTTP boot support.
- **IPv6 PXE Support**  
Enable/Disable IPv6 PXE boot support.
- **IPv6 HTTP Support**  
Enable/Disable IPv6 HTTP boot support.
- **PXE boot wait time**  
Wait time in seconds to press ESC key to abort the PXE boot.
- **Media detect count**  
Number of times the presence of media will be checked.

### 3.2.2.16 CSM Configuration

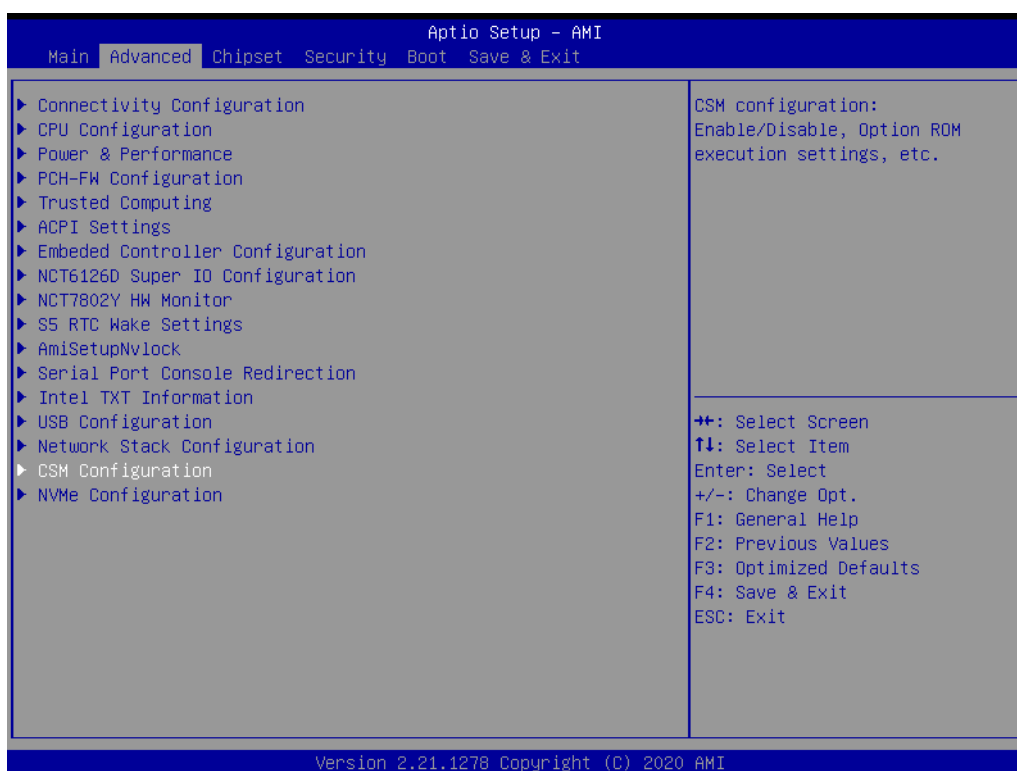



- **CSM Support**  
Enable/Disable CSM Support.

### 3.2.2.17 NVMe Configuration

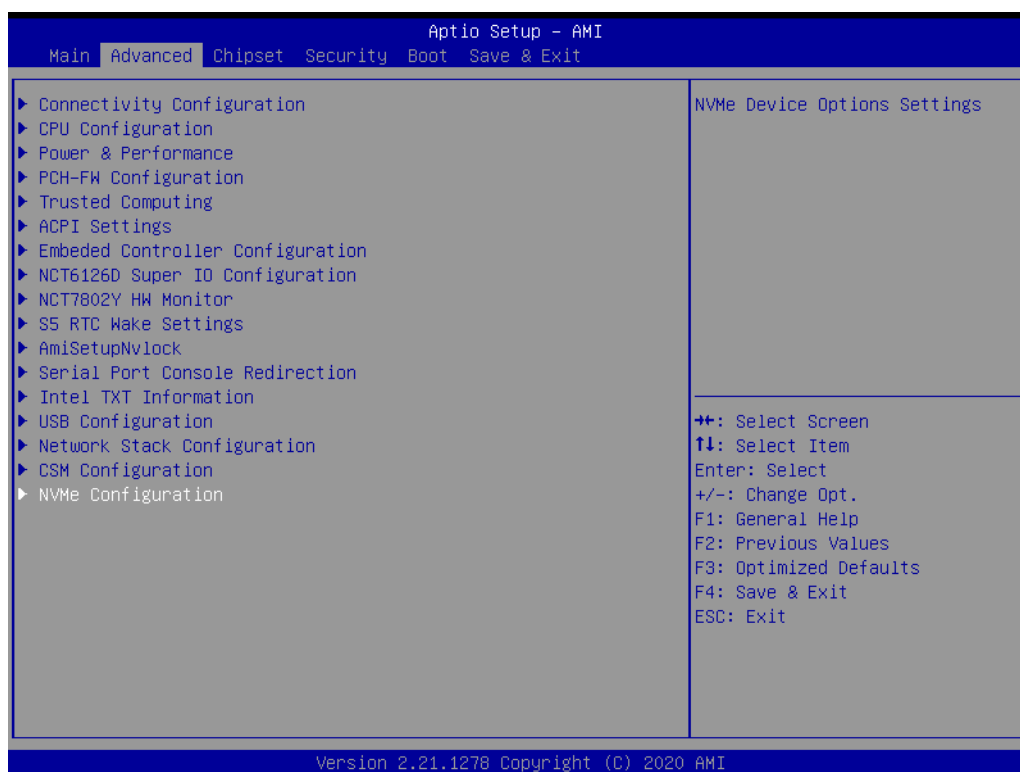



### 3.2.3 Chipset Configuration

Select the Chipset tab from the ARK-3532 setup screen to enter the Chipset BIOS Setup screen. You can display a Chipset BIOS Setup option by highlighting it using the <Arrow> keys. All Plug and Play BIOS Setup options are described in this section. The Plug and Play BIOS Setup screen is shown below.

#### 3.2.3.1 System Agent Configuration



## ■ Memory Configuration Options

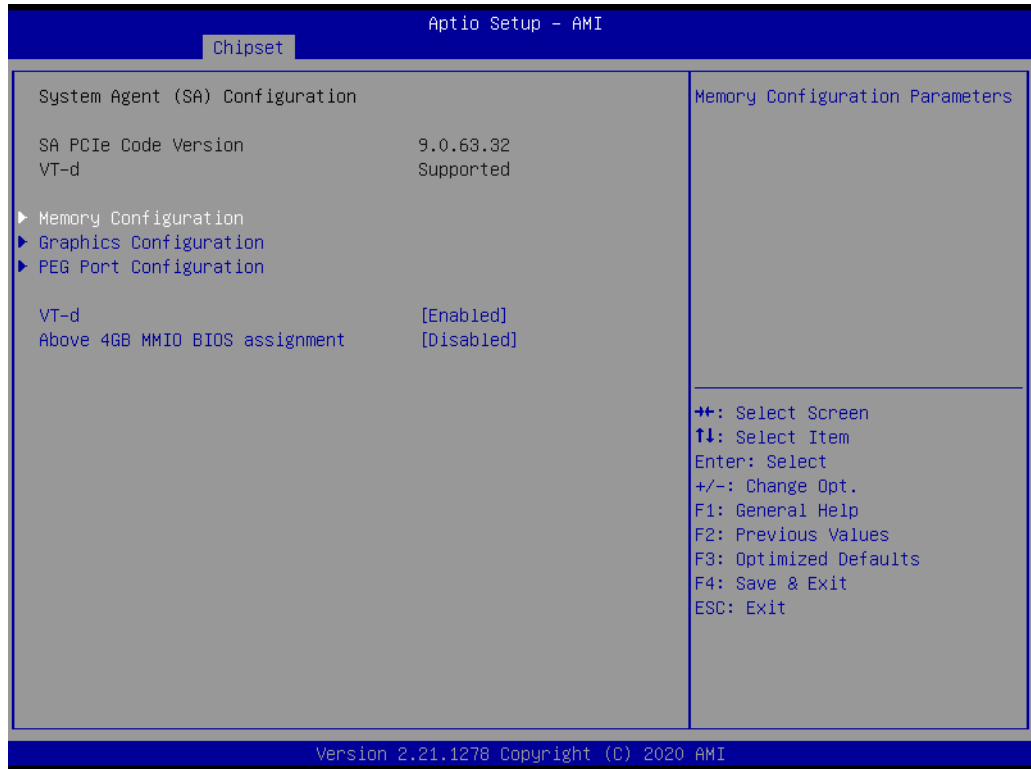

- VT-d  
VT-d capability
- Above 4GB MMIO BIOS assignment  
Enable/Disable above 4GB Memory Mapped I/O BIOS assignment. This is enabled automatically when Aperture Size is set to 2048MB.



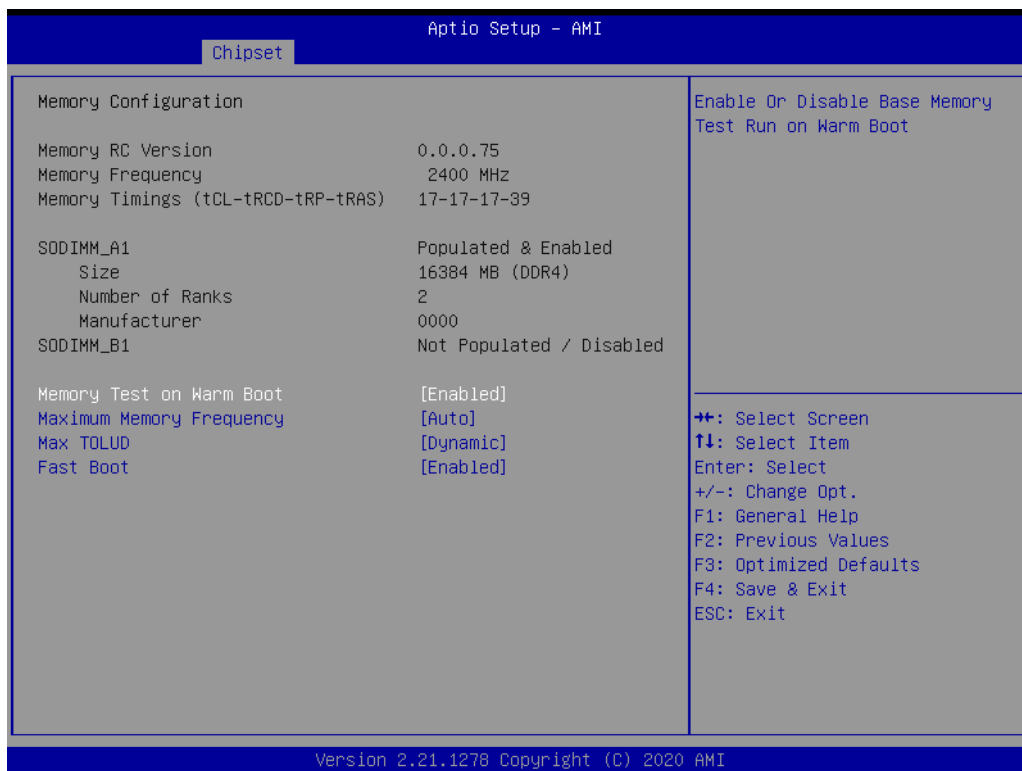

- **Memory Test on Warm Boot**  
Enable or Disable Base Memory Test Run on Warm Boot.
- **Maximum Memory Frequency**  
Maximum Memory Frequency Selections in Mhz.
- **Max TOLUD**  
Maximum Value of TOLUD. Dynamic assignment would adjust TOLUD automatically based on largest MMIO length of installed graphic controller.
- **Fast Boot**  
Enable/Disable fast path through the MRC.

## ■ Graphics Configuration

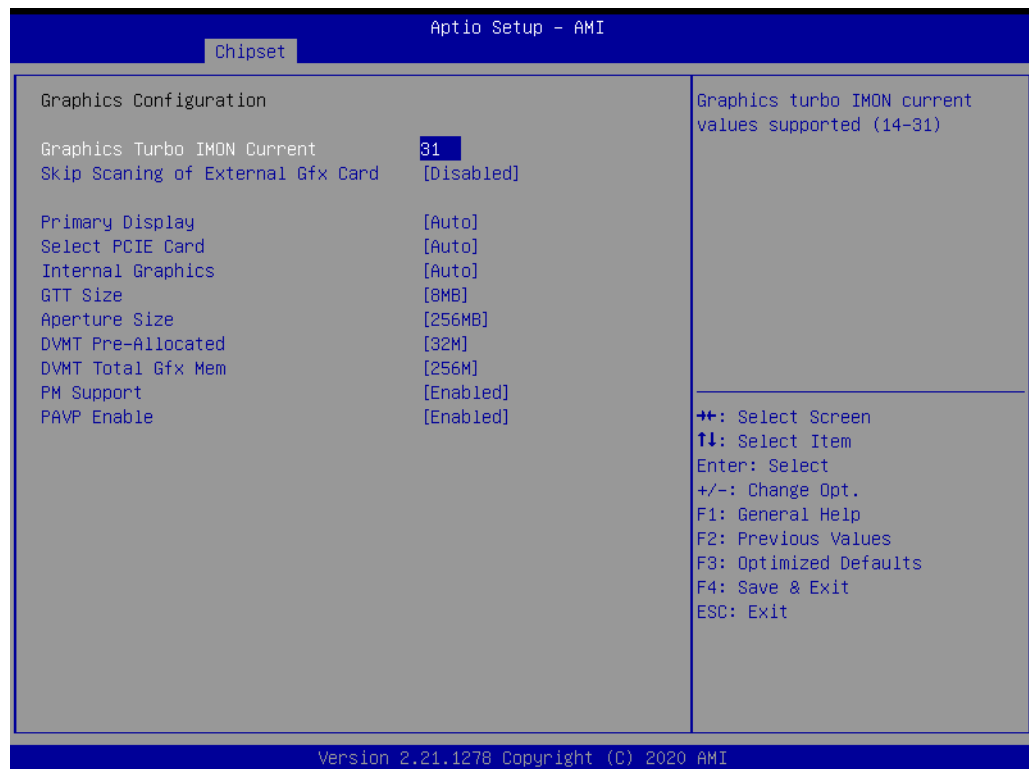

- Graphics Turbo IMON current  
Graphics turbo IMON current values supported (14-31)
- Skip Scanning of External Gfx Card  
If Enabled, it will not scan for External Gfx Card on PEG and PCH PCIE Ports.

- Primary Display  
Select which of IGFX/PEG/PCI Graphics device should be Primary Display or select SG for Switchable Gfx.
- Select PCIE Card  
Select the card used on the platform.
- Internal Graphics  
Keep IGFX enabled based on the setup options.
- GTT Size  
Select the GTT Size.
- Aperture Size  
Select the Aperture Size.
- DVMT Pre-Allocated  
Select DVMT 5.0 Pre-Allocated (Fixed) Graphics Memory size used by the Internal Graphics Device.
- DVMT Total Gfx Mem  
Select DVMT5.0 Total Graphic Memory size used by the Internal Graphics Device.
- PM Support  
Enable/Disable PM Support.
- PAVP Enable  
Enable/Disable PAVP

#### ■ PEG Port Configuration



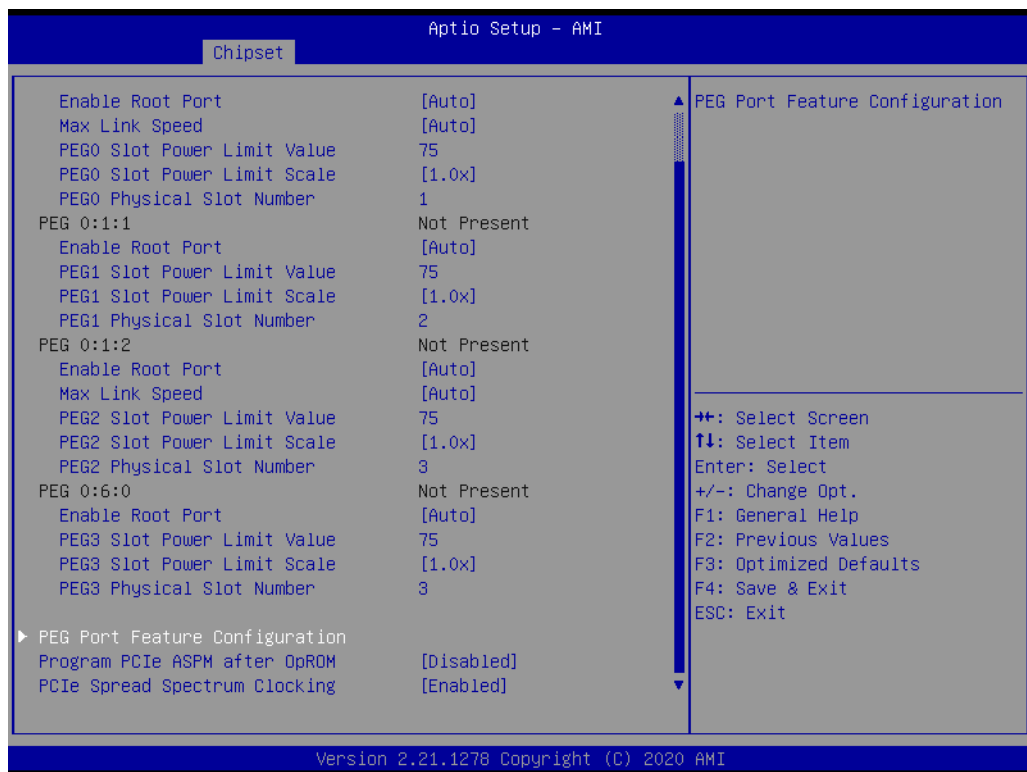
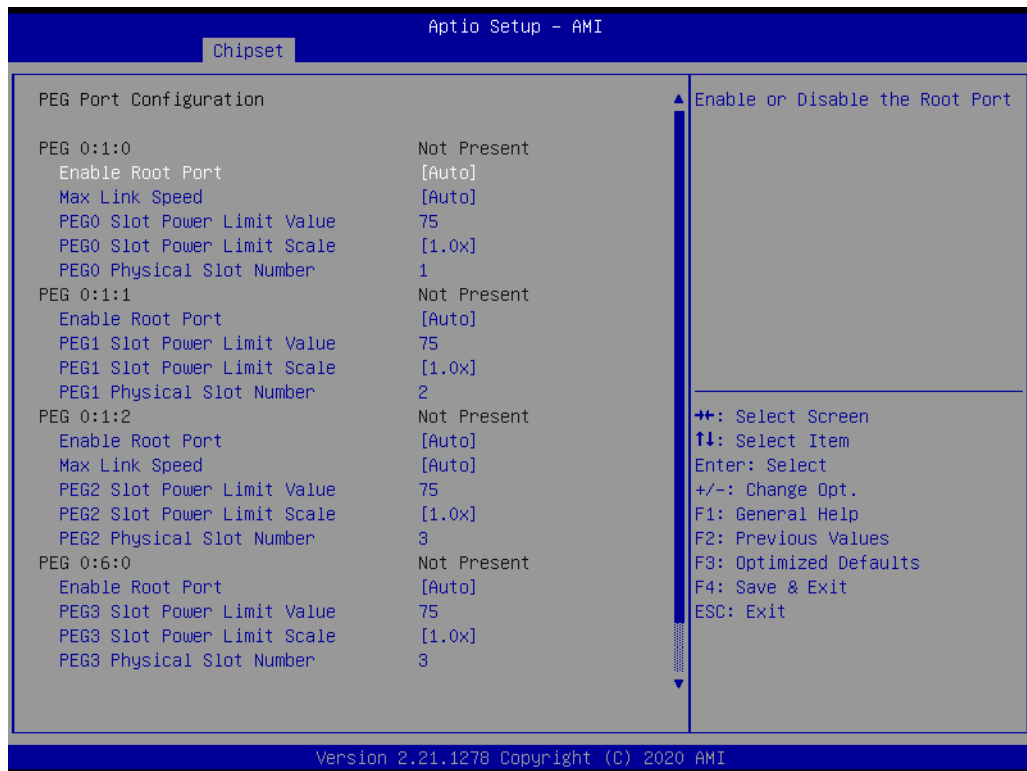

- Enable Root Port  
  Enable or Disable the Root Port.
- Max Link Speed  
  Configure PEG Max Speed
- PEG Slot Power Limit Value  
  Sets the upper limit on power supplied by slot.

- PEG Slot Power Limit Scale  
Select the scale used for the Slot Power Limit Value.
- PEG Physical Slot Number  
Set the physical slot number attached to this Port.
- Program PCIe ASPM after OpROM  
Enabled: PCIe ASPM will be programmed after OpROM.
- PCIe Spread Spectrum Clocking  
Allows disabling of Spread Spectrum Clocking for compliance testing.



- Detect Non-Compliance Device  
Detect Non-Compliance PCI Express Device in PEG.

### 3.2.3.2 PCH-IO Configuration

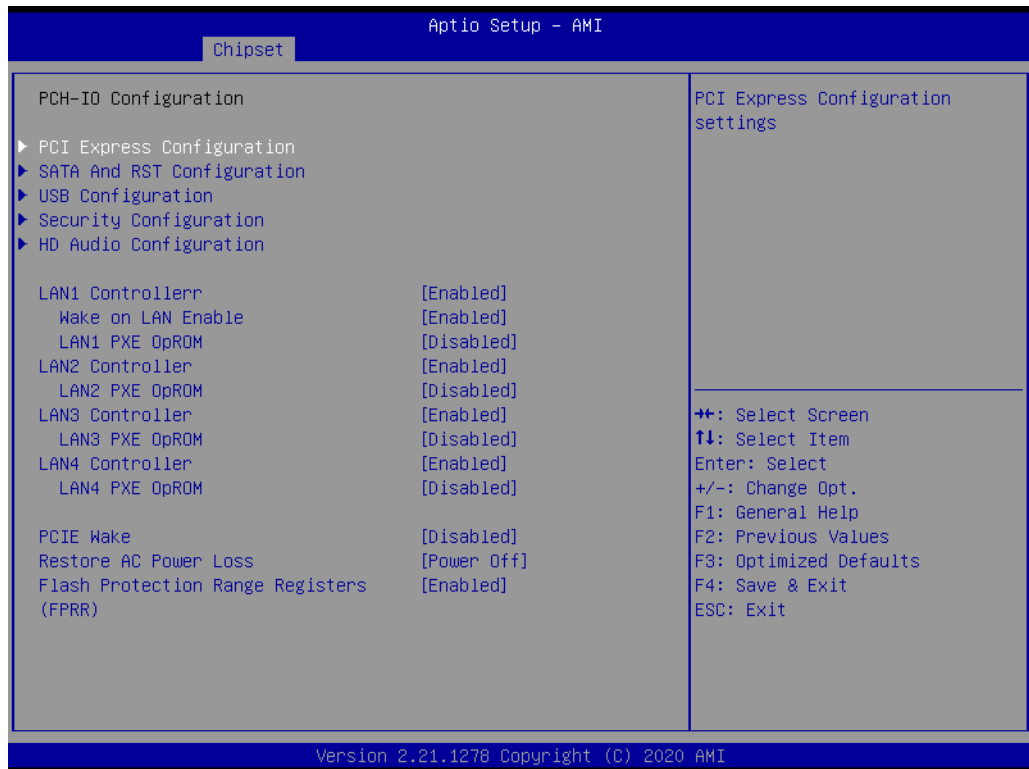

- **LAN1 Controller**  
Enable/Disable onboard NIC
- **Wake on LAN Enable**  
Enable/Disable integrated LAN to wake the system.
- **LAN1 PXE OpROM**

- Enable or disable boot option for LAN1 Controller.
- **LAN2 Controller**  
Enable/Disable LAN2 controller
- **LAN2 PXE OpROM**  
Enable or disable boot option for LAN2 Controller.
- **LAN3 Controller**  
Enable/Disable LAN3 controller
- **LAN3 PXE OpROM**  
Enable or disable boot option for LAN3 Controller.
- **LAN4 Controller**  
Enable/Disable LAN4 controller
- **LAN4 PXE OpROM**  
Enable or disable boot option for LAN4 Controller.
- **PCIE Wake**  
Enable or disable PCIE to wake the system from S5.
- **Restore AC Power Loss**  
Specify what state to go to when power is re-applied after a power failure (G3 state).
- **Flash Protection Range Registers (FPRR)**  
Enable Flash Protection Range Registers.
- **PCI Express Configuration**

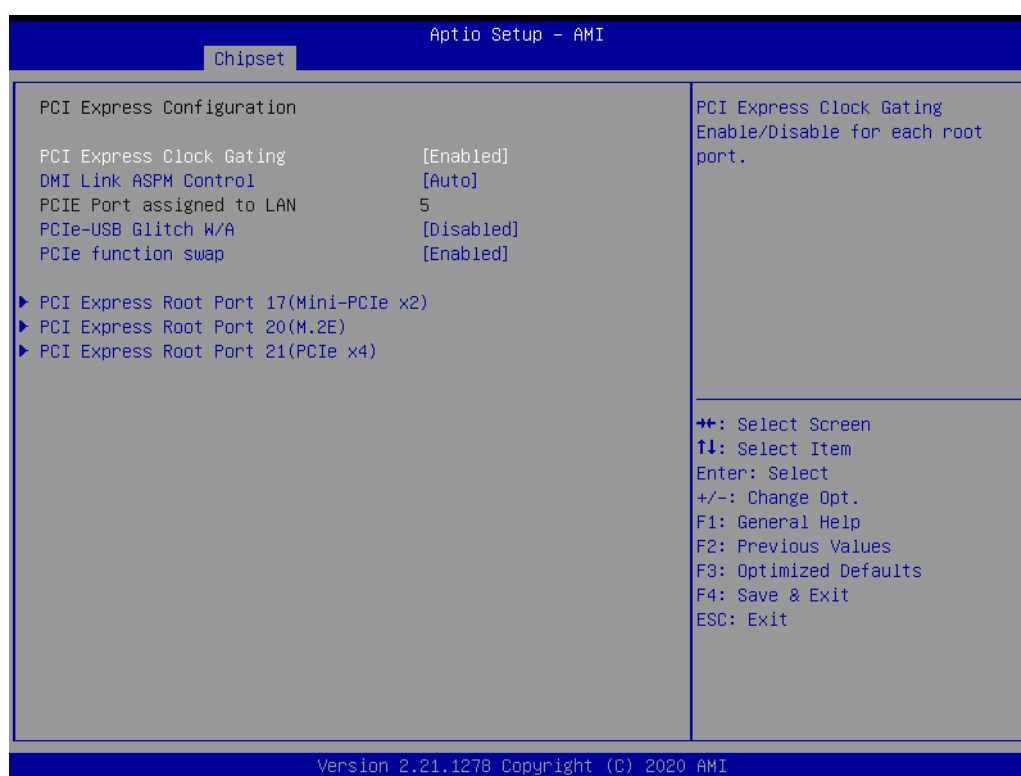

- PCI Express Clock Gating  
PCI Express Clock Gating Enable/Disable for each root port.
- DMI Link ASPM Control  
The control of Active State Power Management of the DMI Link.

- PCIe-USB Glitch W/A  
PCIe-USB Glitch W/A for bad USB device(s) connected behind PCIe/PEG Port.
- PCIe function swap  
When Disabled, it prevents PCIe root-port function swap. If any function other than 0th is enabled, 0th will become visible.

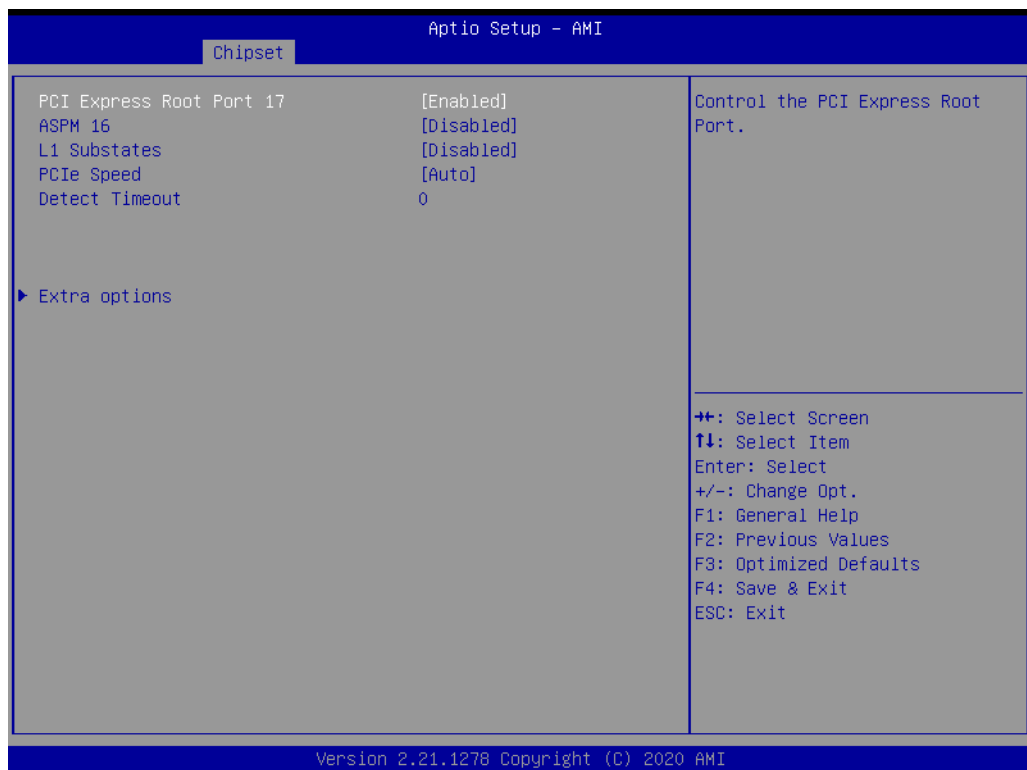
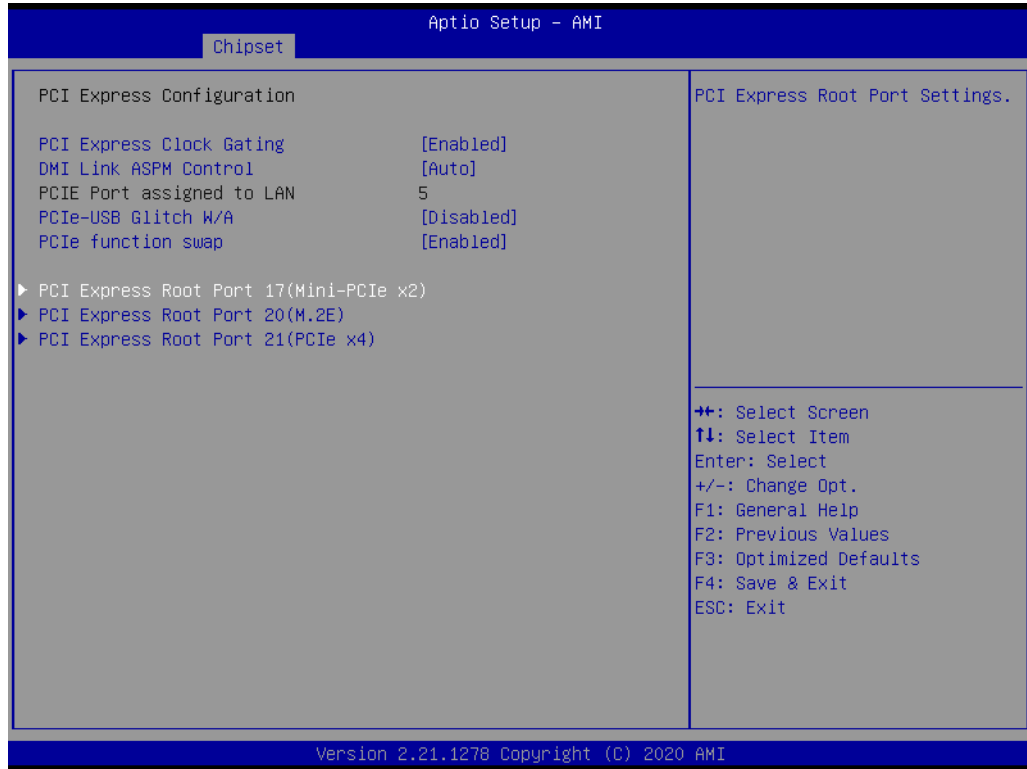

- PCH-PCI Express Root Port  
Control the PCI Express Root Port.



- ASPM-  
Set the ASPM Level.
- L1 Substates  
PCI Express L1 Substates settings.
- PCIe Speed-  
Configure PCIe Speed.
- Detect Timeout  
The number of milliseconds reference code will wait for link to exit detect state for enabled ports before assuming there is no device and potentially disabling the port.

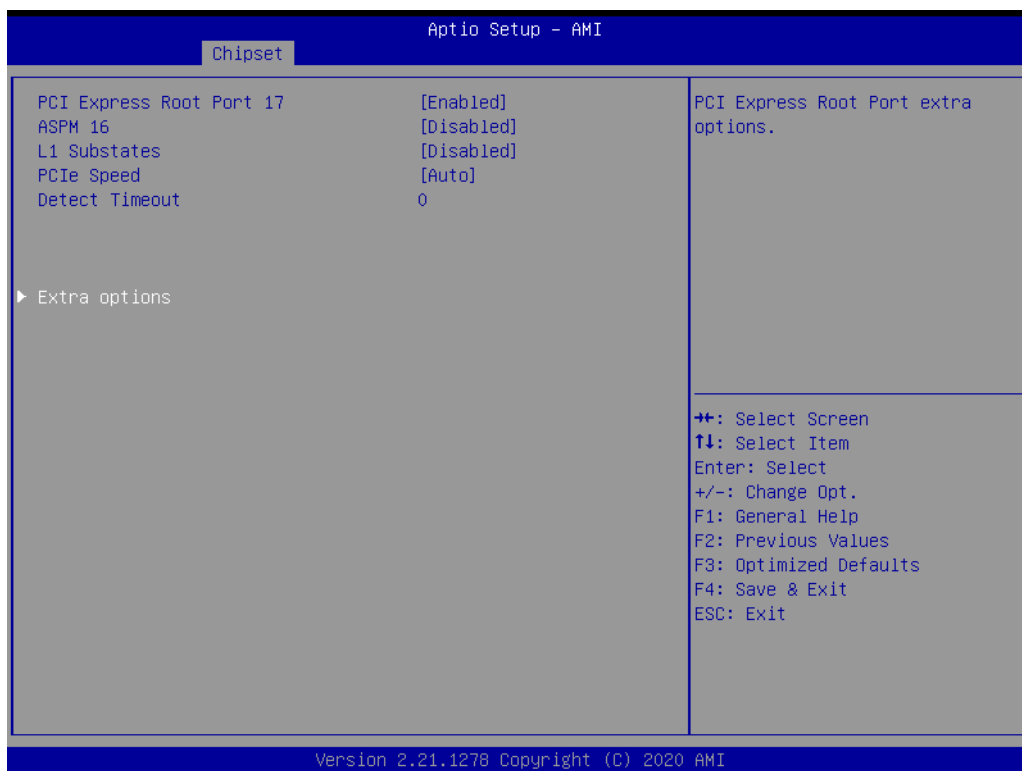

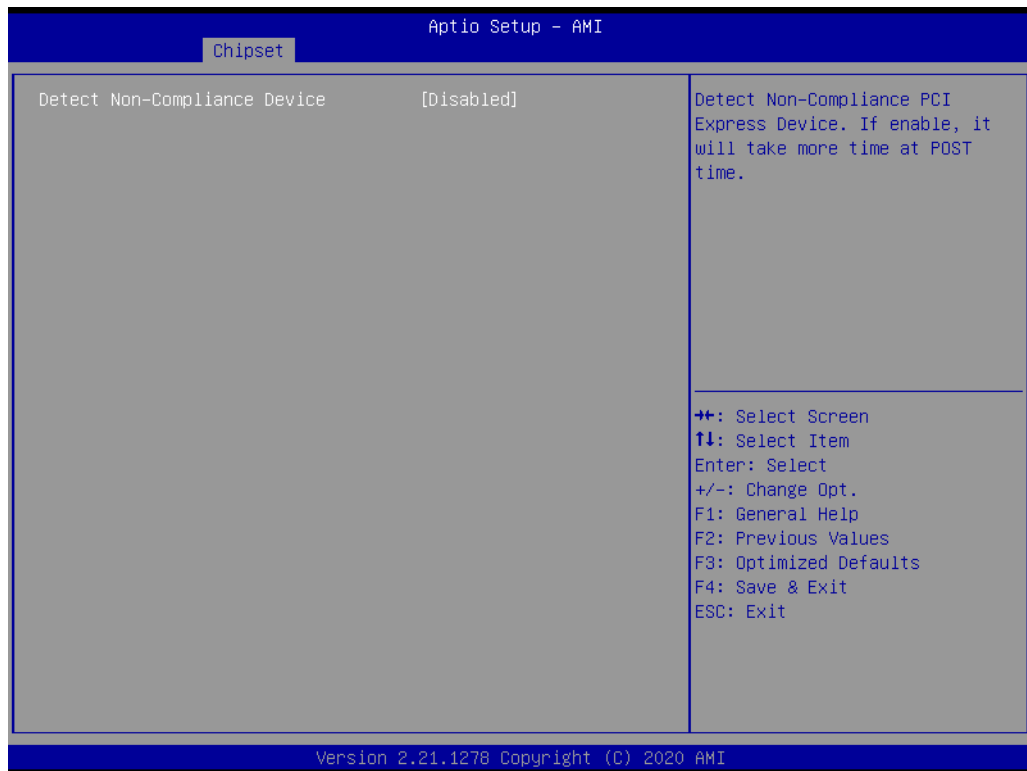

- Detect Non-Compliance Device  
Detect Non-Compliance PCI Express Device. If enabled, it will take more time at POST time.

■ **SATA and RST Configuration**

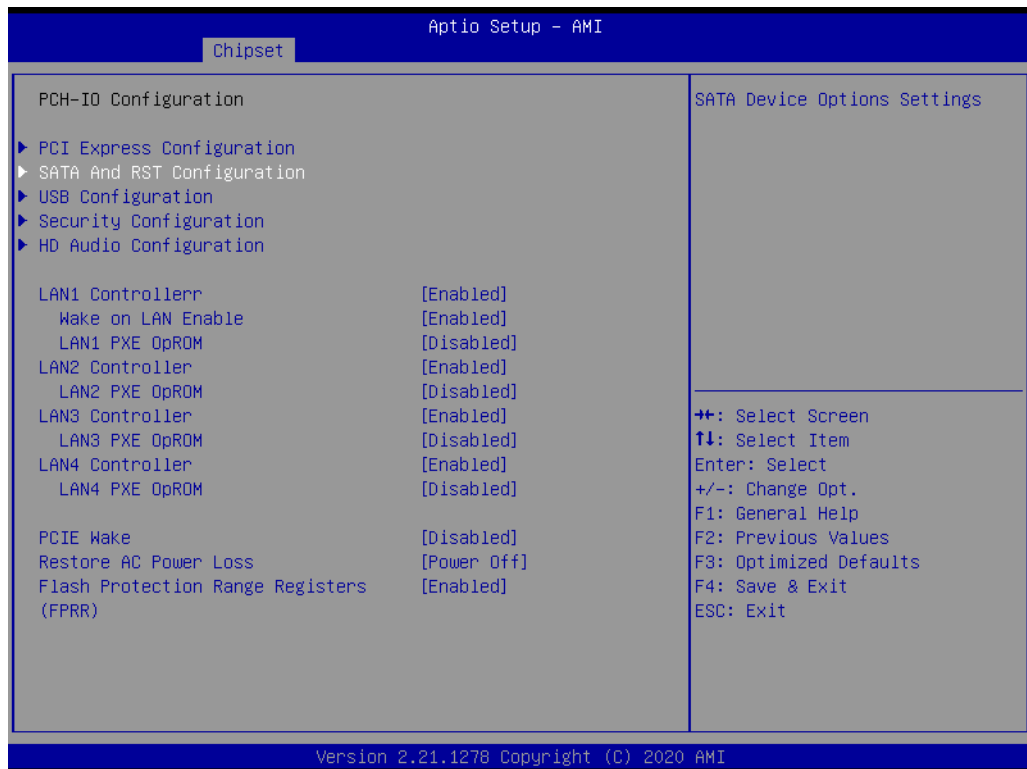

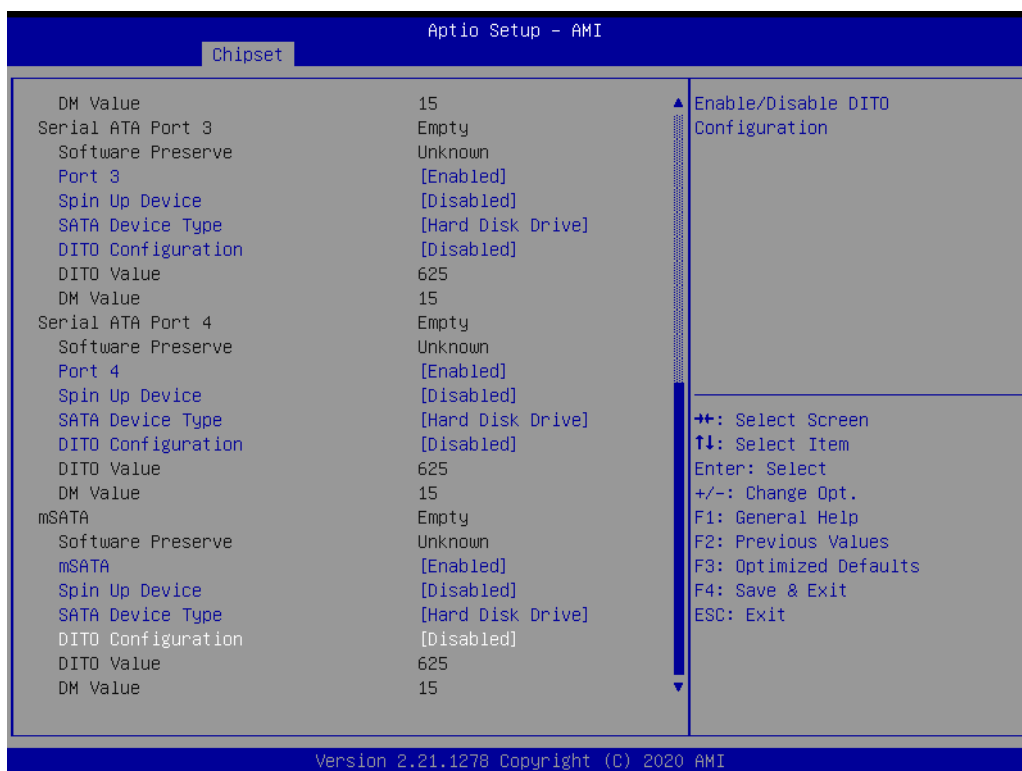
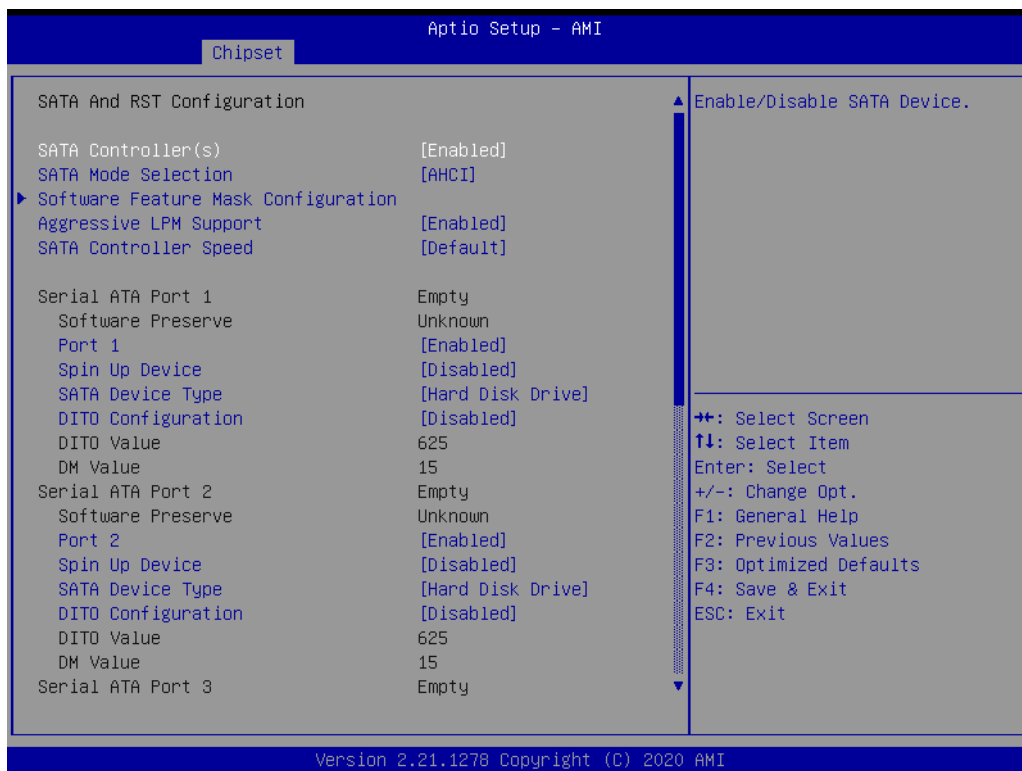

- SATA Controller(s)  
Enable/Disable SATA Device.
- SATA Mode Selection  
Determines how SATA controller(s) operate.
- Aggressive LPM Support  
Enable PCH to aggressively enter link power state.

- SATA Controller Speed-  
Indicates the maximum speed the SATA controller can support.
- Port 1~4/mSATA  
Enable or Disable SATA/mSATA Port
- Spin Up Device  
If enabled for any of ports Staggered Spin Up will be performed and only the drives which have this option enabled will spin up at boot. Otherwise all drives spin up at boot.
- SATA Device Type  
Identify the SATA port is connected to Solid State Drive or Hard Disk Drive.
- DITO Configuration-  
Enable/Disable DITO Configuration.

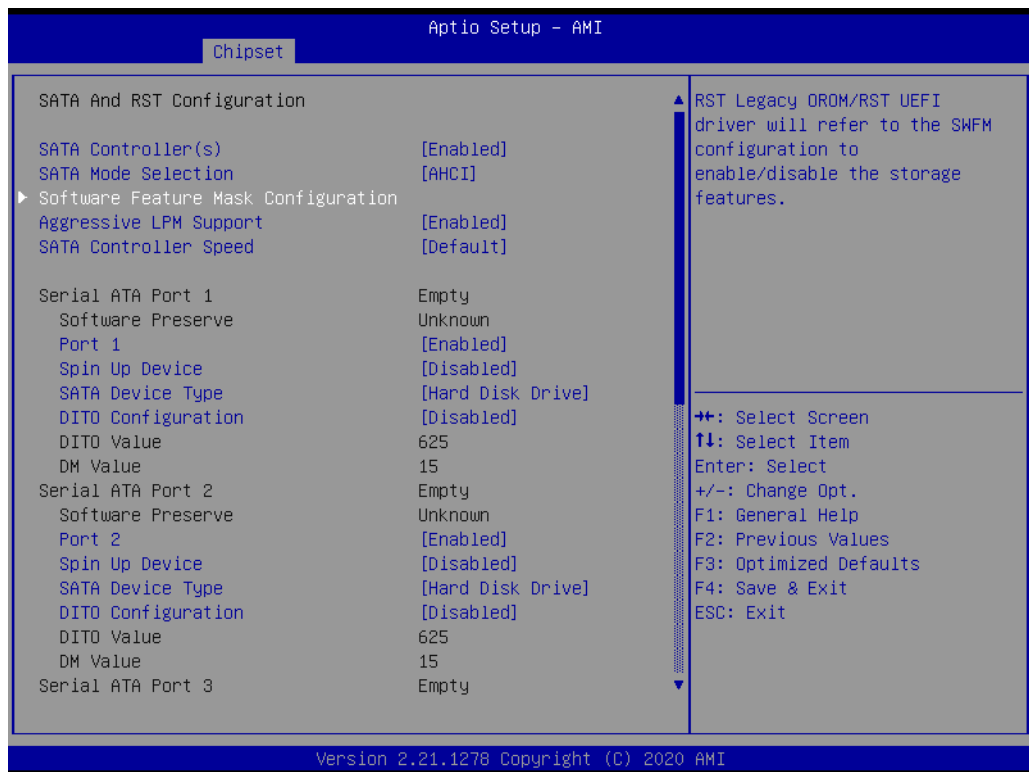

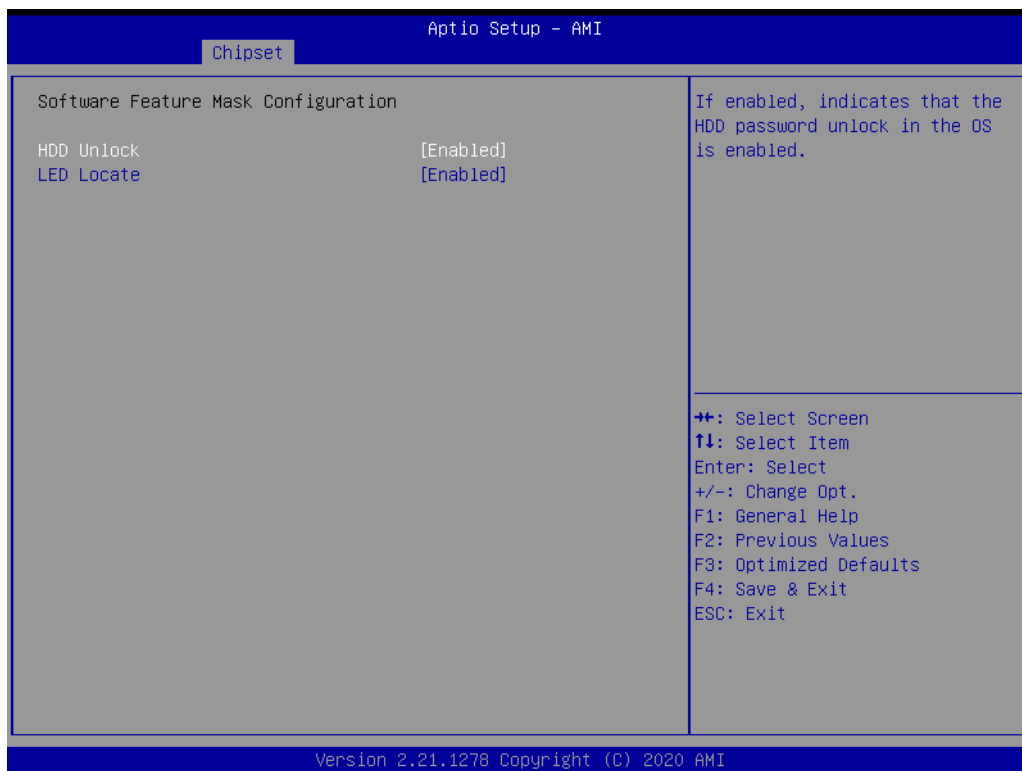

- HDD Unlock  
If enabled, indicates that the HDD password unlock in the OS is enabled.
- LED Locate  
If enabled, indicates that the LED/SGPIO hardware is attached and ping to locate feature is enabled on the OS.

## ■ USB Configuration

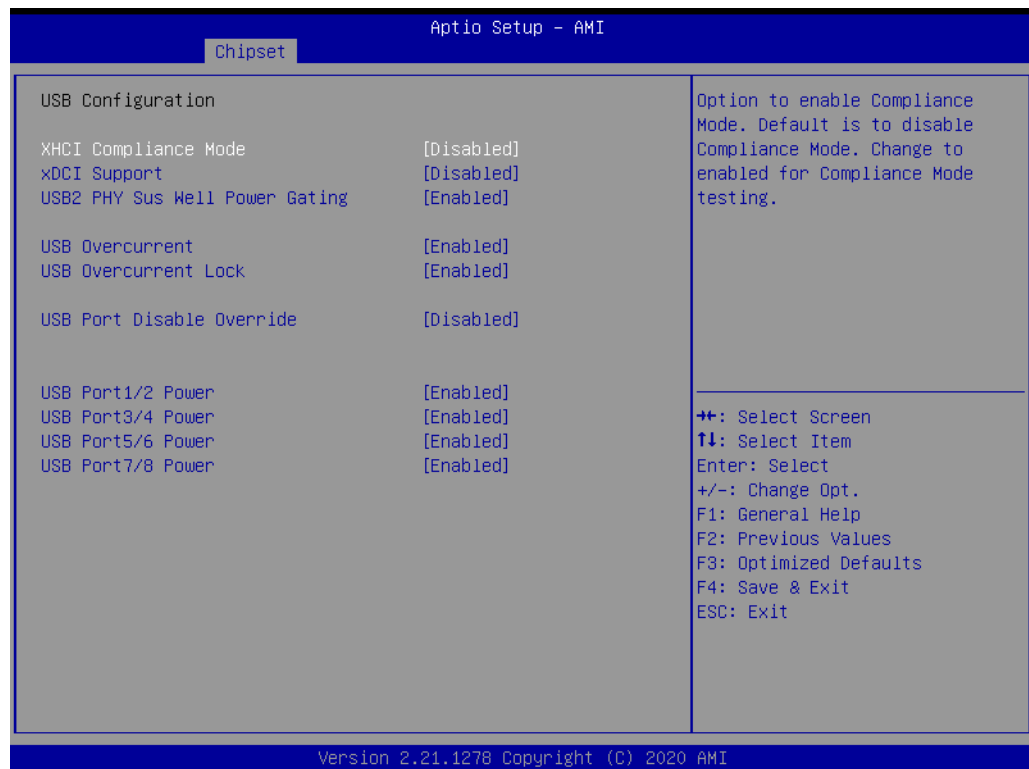

- XHCI Compliance Mode  
Option to enable Compliance Mode. Default is to disable Compliance Mode.
- xDCI Support  
Enable/Disable xDCI (USB OTG Device).

- USB2 PHY Sus Well Power Gating  
Select 'Enabled' to enable SUS Well PG for USB2 PHY. This option has no effect on PCH-H.
- USB Overcurrent  
Select 'Disabled' for pin-based debug. If pin-based debug is enabled but USB overcurrent is not disabled, USB DbC will not work.
- USB Overcurrent Lock  
Select 'Enabled' if Overcurrent functionality is used. Enabling this will make xHCI controller consume the Overcurrent mapping data
- USB Port Disable Override  
Selectively Enable/Disable the corresponding USB port from reporting a Device Connection to the controller.
- USB Port Power  
Enable/Disable USB ports power in S4/S5.

## ■ Security Configuration

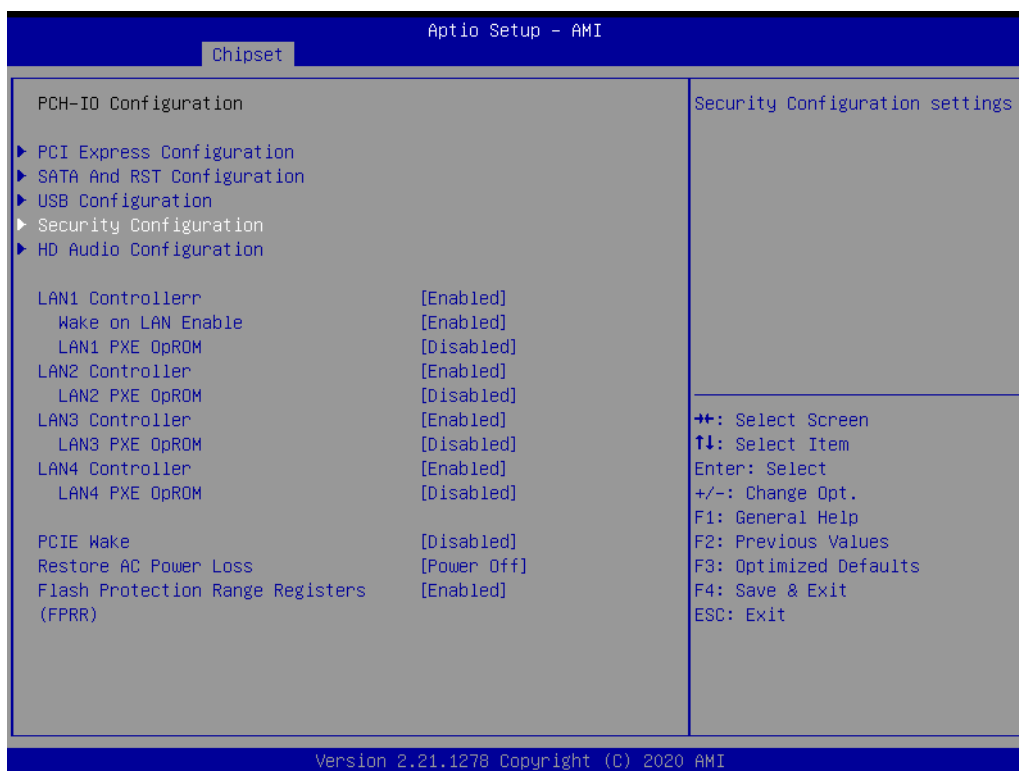



- RTC Memory Lock  
Enable will lock bytes 38h-3Fh in the lower/upper 128-byte bank of RTC RAM.
- BIOS Lock  
Enable/Disable the PCH BIOS Lock Enable feature. Required to be enabled to ensure SMM protection of flash.
- Force unlock on all GPIO pads  
If Enabled BIOS will force all GPIO pads to be in unlocked state.



## ■ HD Audio Configuration

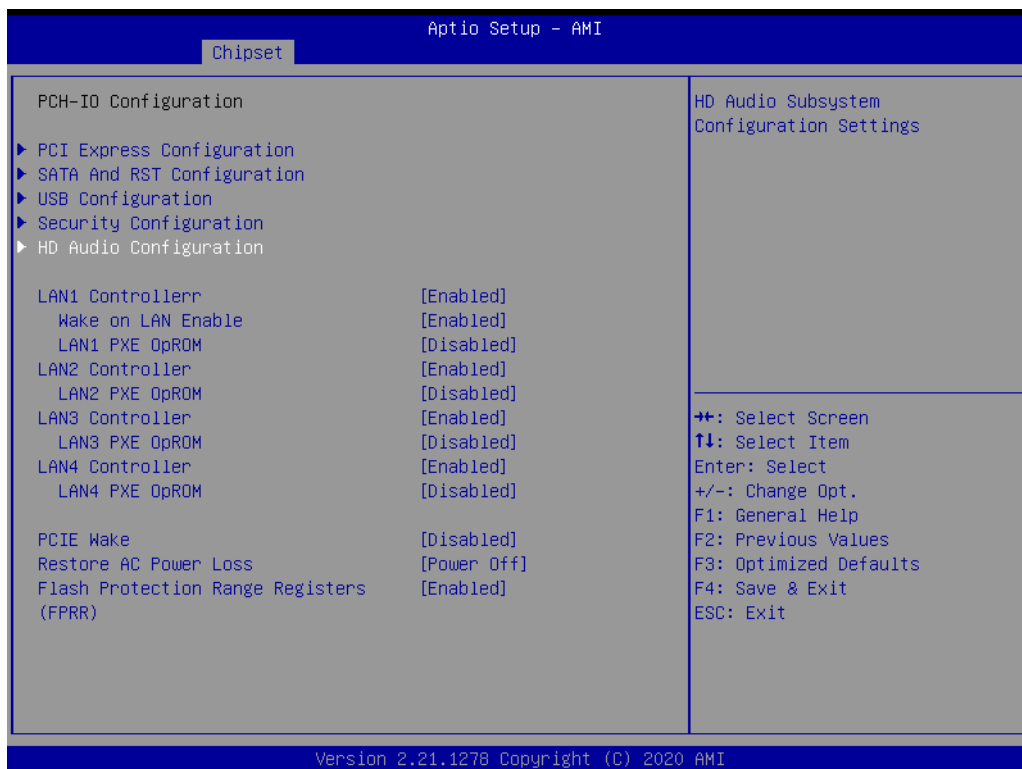

- HD Audio  
Control Detection of the HD-Audio device.

## 3.2.4 Security



- **Administrator Password**  
Set Administrator Password
- **User Password**  
Set User Password

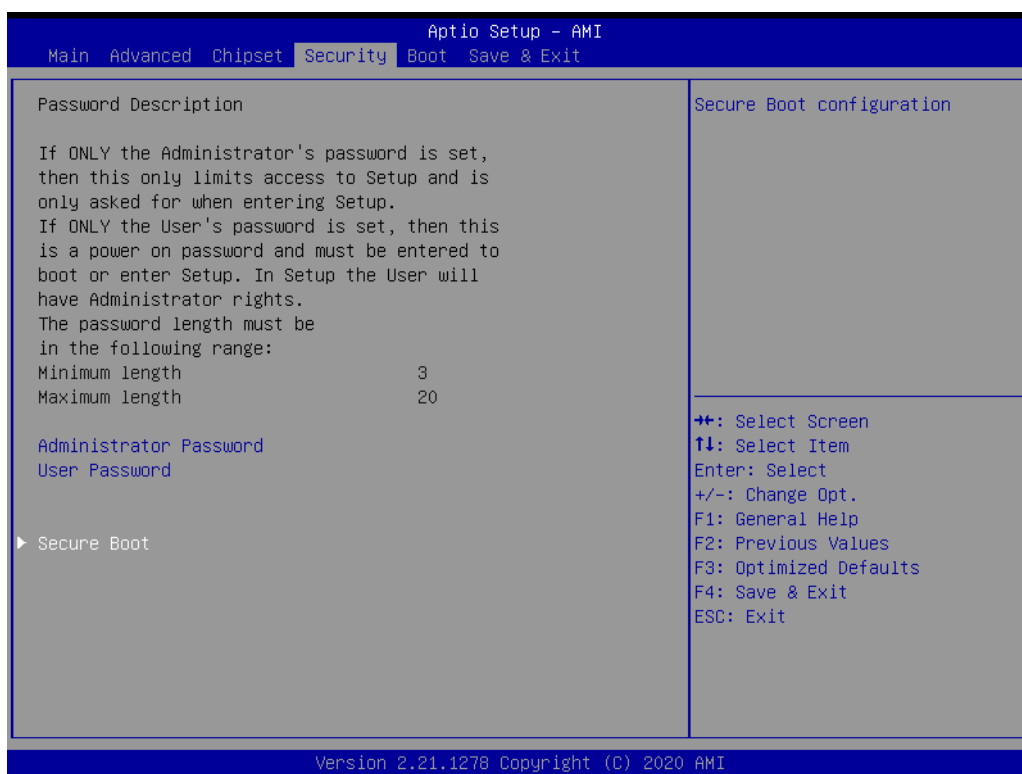

- Secure Boot  
Secure Boot feature is Active if Secure Boot is Enabled, Platform Key (PK) is enrolled and the System is in User mode. The mode change requires platform reset.
- Secure Boot Mode  
Secure Boot mode options: Standard or Custom.

## 3.2.5 Boot

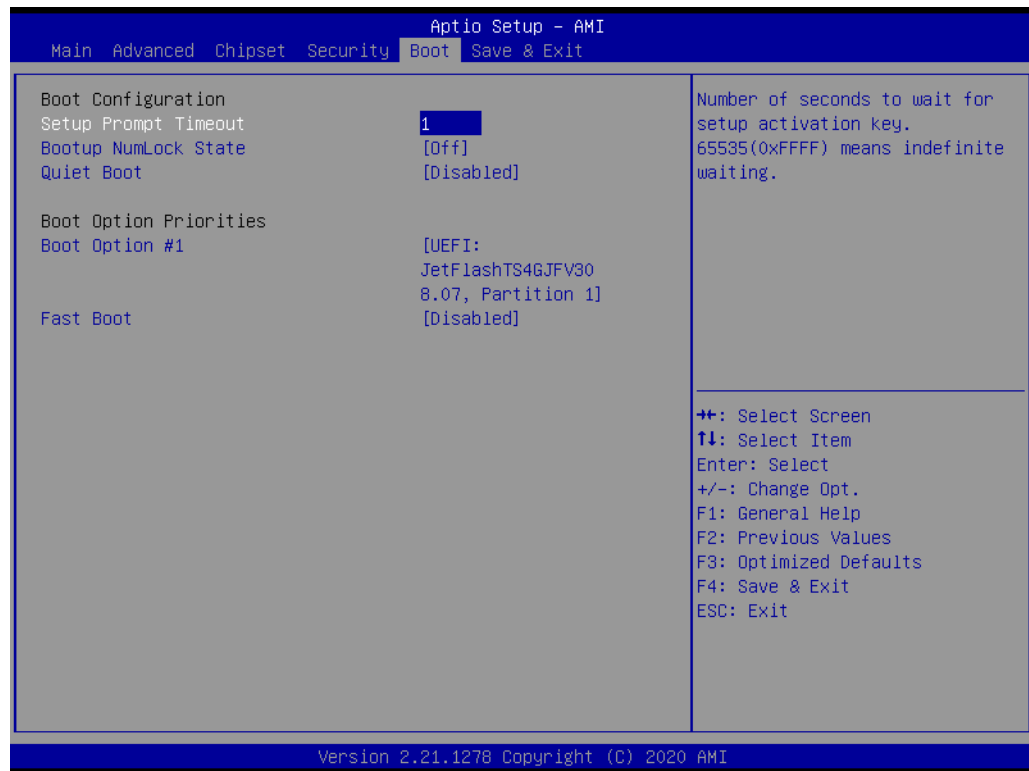

- **Setup Prompt Timeout**  
Number of seconds to wait for setup activation key. 65535 (0xFFFF) means indefinite waiting.
- **Bootup NumLock State**  
Select the keyboard NumLock state
- **Quiet Boot**  
Enables or disables Quiet Boot option
- **Fast Boot**  
Enables or disables boot with initialization of a minimal set of devices required to launch active boot option. Has no effect for BBS boot options.

### 3.2.6 Save & Exit



- **Save Changes and Exit**  
Exit system setup after saving the changes.
- **Discard Changes and Exit**  
Exit system setup without saving any changes.
- **Save Changes and Reset**  
Reset the system after saving the changes.
- **Discard Changes and Reset**  
Reset system setup without saving any changes.
- **Save Changes**  
Save Changes done so far to any of the setup options.
- **Discard Changes->Discard Changes done so far to any of the setup options**
- **Restore Defaults**  
Restore/Load Default values for all the setup options.
- **Save as User Defaults**  
Save the changes done so far as User Defaults.
- **Restore User Defaults**  
Restore the User Defaults to all the setup options.



# Appendix **A**

Watchdog Timer  
Sample Code

## A.1 EC Watchdog Timer Sample Code

```
EC_Command_Port = 0x29Ah
EC_Data_Port = 0x299h
Write EC HW ram = 0x89
Watch dog event flag = 0x57
Watchdog reset delay time = 0x5E
Reset event = 0x04
Start WDT function = 0x28
=====
.model small
.486p
.stack 256
.data
.code
org 100h
.STARTup

mov dx, EC_Command_Port
mov al,89h ; Write EC HW ram.
out dx,al

mov dx, EC_Data_Port
mov al, 5Fh ; Watchdog reset delay time low byte (5Eh is high byte) index, Timebase:
100ms
out dx,al

mov dx, EC_Data_Port
mov al, 64h ;Set 10 seconds delay time.
out dx,al

mov dx, EC_Command_Port
mov al,89h ; Write EC HW ram.
out dx,al

mov dx, EC_Data_Port
mov al, 57h ; Watch dog event flag.
out dx,al

mov dx, EC_Data_Port
mov al, 04h ; Reset event.
out dx,al

mov dx, EC_Command_Port
mov al,28h ; start WDT function. (Stop: 0x29, Reset: 0x2A)
out dx,al

.exit
END
```



# Appendix **B**

Fixing the LAN order

## B.1 Problem Statement

When installing Windows 10, the inbox driver will recognize the I210 LAN chip and arrange it to the first order. After installing the LAN driver, the first/second/third LAN order will be I210. The fourth is I219.

This doesn't match the device cabinets LAN sign.

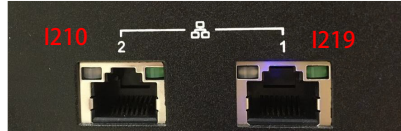

Before users install the LAN driver:

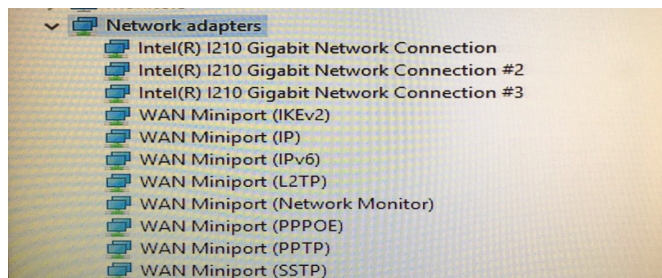

After installing the LAN driver, you will see I219 is set to Ethernet 4.

```
C:\Windows\system32\cmd.exe

Ethernet adapter Ethernet:

    Media State . . . . . : Media disconnected
    Connection-specific DNS Suffix . . . . . :
    Description . . . . . : Intel(R) I210 Gigabit Network Connection
    Physical Address. . . . . : C4-00-AD-54-36-46
    DHCP Enabled. . . . . : Yes
    Autoconfiguration Enabled . . . . . : Yes

Ethernet adapter Ethernet 2:

    Media State . . . . . : Media disconnected
    Connection-specific DNS Suffix . . . . . :
    Description . . . . . : Intel(R) I210 Gigabit Network Connection #2
    Physical Address. . . . . : C4-00-AD-54-36-47
    DHCP Enabled. . . . . : Yes
    Autoconfiguration Enabled . . . . . : Yes

Ethernet adapter Ethernet 3:

    Media State . . . . . : Media disconnected
    Connection-specific DNS Suffix . . . . . :
    Description . . . . . : Intel(R) I210 Gigabit Network Connection #3
    Physical Address. . . . . : C4-00-AD-54-36-48
    DHCP Enabled. . . . . : Yes
    Autoconfiguration Enabled . . . . . : Yes

Ethernet adapter Ethernet 4:

    Media State . . . . . : Media disconnected
    Connection-specific DNS Suffix . . . . . :
    Description . . . . . : Intel(R) Ethernet Connection (7) I219-LM
```

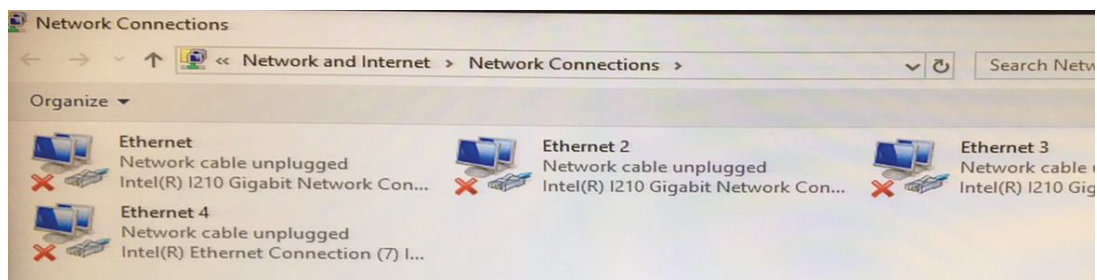

## B.2 Addressing the LAN Order

You have to disable LAN2/3/4 which is I210 LAN chip in the first BIOS screen.

Then install the Win 10 OS. After installing the LAN driver, the order will match the sign on the cabinet.

Disable the LAN 2/3/4 controller in BIOS.(BIOS→Chipset→PCH-IO configuration 2/3/4 controller = Disabled).

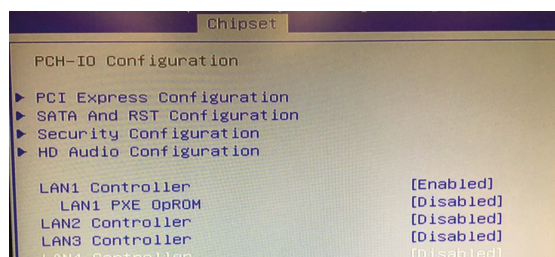

You won't see any LAN adapter before installing the LAN driver.

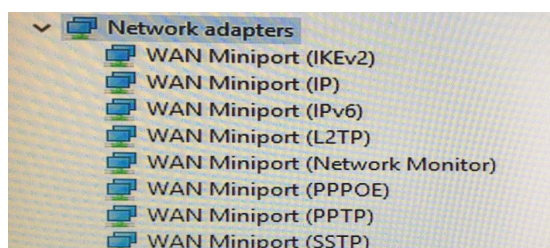

I219 will be recognized after installing the LAN driver.

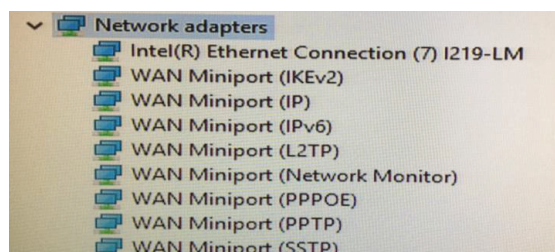

Enable LAN2/3/4 controller in BIOS.

Finally, enter the OS to make sure the LAN order matches the sign on the cabinet.

I219 will become the first LAN order.

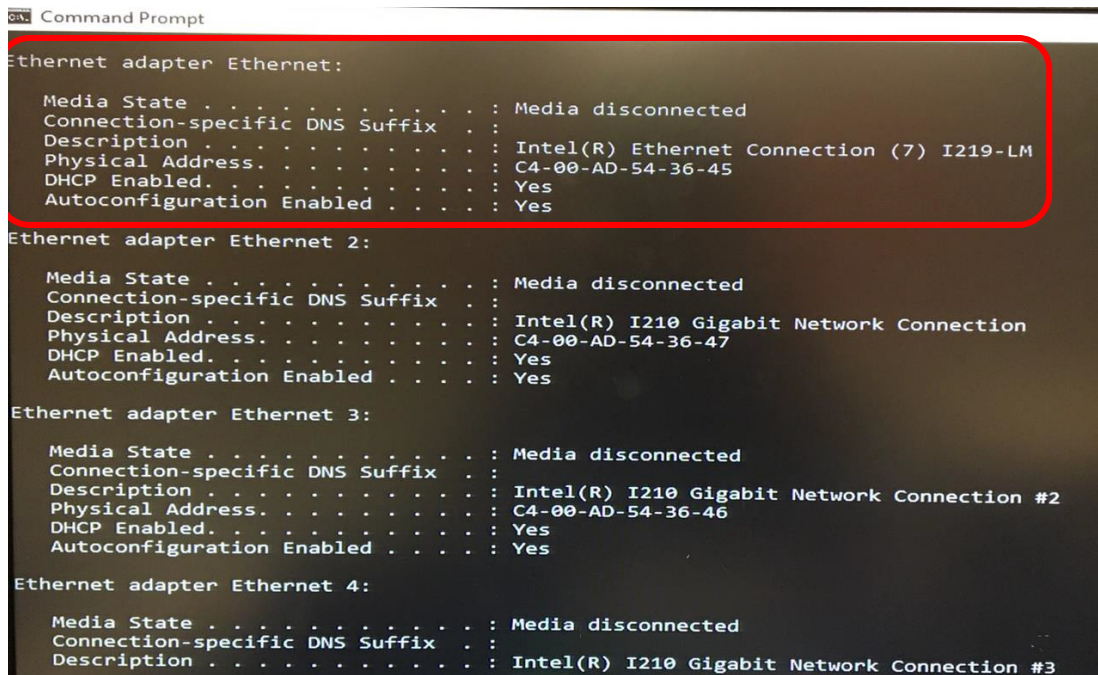
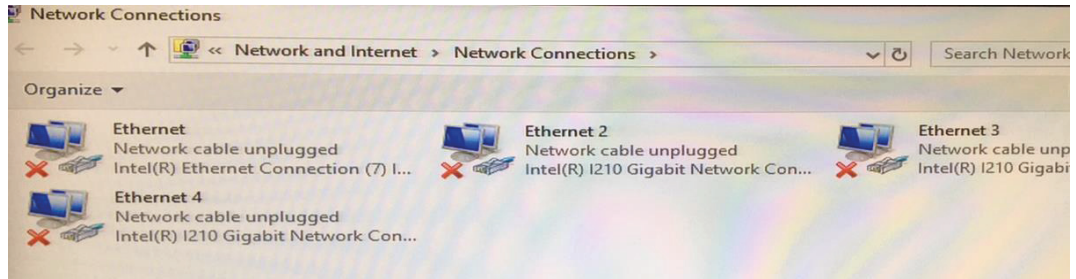



**ADVANTECH**

*Enabling an Intelligent Planet*

**[www.advantech.com](http://www.advantech.com)**

Please verify specifications before quoting. This guide is intended for reference purposes only.

All product specifications are subject to change without notice.

No part of this publication may be reproduced in any form or by any means, electronic, photocopying, recording or otherwise, without prior written permission from the publisher.

All brand and product names are trademarks or registered trademarks of their respective companies.

© Advantech Co., Ltd. 2021