



User Manual

ARK-2121

Fanless Embedded Box Computer

ADVANTECH

Enabling an Intelligent Planet

Attention!

Please note:

This package contains a hard-copy user manual in Chinese for China CCC certification purposes, and there is an English user manual included as a PDF file on the CD. Please disregard the Chinese hard copy user manual if the product is not to be sold and/or installed in China.

Notez s'il vous plaît:

Ce paquet contient un manuel de l'utilisateur sur papier en chinois à des fins de certification CCC pour la Chine, et un manuel de l'utilisateur en anglais est inclus sous forme de fichier PDF sur le CD. Veuillez ne pas tenir compte du manuel de l'utilisateur sur papier chinois si le produit ne doit pas être vendu et / ou installé en Chine.

甲類警語

警告使用者：這是甲類資訊產品，在居住環境使用時，可能造成射頻干擾，在這種情況下，使用者會被要求採取某些適當對策。

Copyright

The documentation and the software included with this product are copyrighted 2020 by Advantech Co., Ltd. All rights are reserved. Advantech Co., Ltd. reserves the right to make improvements in the products described in this manual at any time without notice.

No part of this manual may be reproduced, copied, translated or transmitted in any form or by any means without the prior written permission of Advantech Co., Ltd. Information provided in this manual is intended to be accurate and reliable. However, Advantech Co., Ltd. assumes no responsibility for its use, nor for any infringements of the rights of third parties, which may result from its use.

Acknowledgments

Award is a trademark of Award Software International, Inc.

VIA is a trademark of VIA Technologies, Inc.

IBM, PC/AT, PS/2 and VGA are trademarks of International Business Machines Corporation.

Intel® and Pentium® are trademarks of Intel Corporation.

Microsoft Windows® is a registered trademark of Microsoft Corp.

RTL is a trademark of Realtek Semi-Conductor Co., Ltd.

ESS is a trademark of ESS Technology, Inc.

UMC is a trademark of United Microelectronics Corporation.

SMI is a trademark of Silicon Motion, Inc.

Creative is a trademark of Creative Technology LTD.

CHRONTEL is a trademark of Chrontel Inc.

All other product names or trademarks are properties of their respective owners.

For more information about this and other Advantech products, please visit our website at:

<http://www.advantech.com/>

<http://www.advantech.com/ePlatform/>

For technical support and service, please visit our support website at:

<http://support.advantech.com.tw/support/>

Product Warranty (2 years)

Advantech warrants to you, the original purchaser, that each of its products will be free from defects in materials and workmanship for two years from the date of purchase.

This warranty does not apply to any products which have been repaired or altered by persons other than repair personnel authorized by Advantech, or which have been subject to misuse, abuse, accident or improper installation. Advantech assumes no liability under the terms of this warranty as a consequence of such events.

Because of Advantech's high quality-control standards and rigorous testing, most of our customers never need to use our repair service. If an Advantech product is defective, it will be repaired or replaced at no charge during the warranty period. For out-of-warranty repairs, you will be billed according to the cost of replacement materials, service time and freight. Please consult your dealer for more details.

If you think you have a defective product, follow these steps:

1. Collect all the information about the problem encountered. (For example, CPU speed, Advantech products used, other hardware and software used, etc.) Note anything abnormal and list any onscreen messages you get when the problem occurs.
2. Call your dealer and describe the problem. Please have your manual, product, and any helpful information readily available.
3. If your product is diagnosed as defective, obtain an return merchandise authorization (RMA) number from your dealer. This allows us to process your return more quickly.
4. Carefully pack the defective product, a fully-completed Repair and Replacement Order Card and a photocopy proof of purchase date (such as your sales receipt) in a shippable container. A product returned without proof of the purchase date is not eligible for warranty service.
5. Write the RMA number visibly on the outside of the package and ship it prepaid to your dealer.

Declaration of Conformity

FCC Class A

Note: This equipment has been tested and found to comply with the limits for a Class A digital device, pursuant to part 15 of the FCC Rules. These limits are designed to provide reasonable protection against harmful interference when the equipment is operated in a commercial environment. This equipment generates, uses, and can radiate radio frequency energy and, if not installed and used in accordance with the instruction manual, may cause harmful interference to radio communications. Operation of this equipment in a residential area is likely to cause harmful interference in which case the user will be required to correct the interference at his own expense.

Technical Support and Assistance

1. Visit the Advantech web site at www.advantech.com/support where you can find the latest information about the product.
2. Contact your distributor, sales representative, or Advantech's customer service center for technical support if you need additional assistance. Please have the following information ready before you call:
 - Product name and serial number
 - Description of your peripheral attachments
 - Description of your software (operating system, version, application software, etc.)
 - A complete description of the problem
 - The exact wording of any error messages

Warnings, Cautions, and Notes

Warning! *Warnings indicate conditions, which if not observed, can cause personal injury!*



Avertissement! *Les avertissements indiquent des conditions qui, si elles ne sont pas respectées, peuvent provoquer des blessures!*



Caution! *Cautions are included to help you avoid damaging hardware or losing data. e.g.*



There is a danger of a new battery exploding if it is incorrectly installed. Do not attempt to recharge, force open, or heat the battery. Replace the battery only with the same or equivalent type recommended by the manufacturer. Discard used batteries according to the manufacturer's instructions.

Précautions! *Des précautions sont incluses pour vous aider à éviter d'endommager le matériel ou de perdre des données. par exemple.*



Il y a un risque d'explosion d'une nouvelle batterie si elle n'est pas installée correctement. N'essayez pas de recharger, d'ouvrir de force ou de chauffer la batterie. Remplacez la batterie uniquement par un type identique ou équivalent recommandé par le fabricant. Jetez les piles usagées conformément aux instructions du fabricant.

Note! *Notes provide optional additional information.*



Note! *Notes provide optional additional information.*



Packing List

Before installation, please ensure the following items have been shipped:

- 1 x ARK-2121 unit
- 1 x Registration and 2 years Warranty card
- 1 x China RoHS
- 1 x 2-Pole Phoenix to DC-Jack Power cable
- 1 x SUSI Access Utility CD
- 1 x Simplified Chinese manual

Ordering Information

Model Number	Description
ARK-2121L-U0A1E	Celeron J1900 2.0GHz w/HDMI, VGA, dual GbE, 4x COM, 4x USB, iDoor

Optional Accessories

For ARK-2121L

Part Number	Description
1757003659	AC-to-DC Adapter, DC19 V/3.42 A 65 W, with Phoenix Power Plug, 0 ~ 40 °C (32 ~ 104 ° F) for Home and Office Use
1700001947	Power cable 2-pin 180 cm (70.8 in), USA for ARK-338X
1700001948	Power cable 2-pin 180 cm (70.8 in), Europe for ARK-338X
1700001949	Power cable 2-pin 180 cm (70.8 in), UK for ARK-338X
MOS-1120Y-0202E	Isolated RS-232, 2-Ch, DB9
MOS-1120Y-1402E	Non-Isolated RS-232, DB37, 4-Ch
MOS-1121Y-0202E	Isolated RS-422/485, 2-Ch, DB9
MOS-1121Y-1402E	Non-Isolated RS-422/485, DB37, 4-Ch
MOS-2120-Z1101E	Giga LAN Ethernet module, 1-Ch
MOS-2220-Z1101E	High Speed Serial COM module, 1-Ch
MOS-2220-X1101E	Parallel LPT module, 1-Ch, USB I/F
MOS-1130Y-0201E	Isolated CANBus, 2-Ch, DB9, PCIe I/F
MOS-2230-Z1201E	CANBus module, 2-Ch, USB I/F
MOS-1110Y-0101E	Isolated 16 DI/8 DO, 1-Ch, DB37, PCIe I/F
MOS-2110Z-1201E	USB module, 2-Ch, PCIe I/F
MOS-2120-Z1201	Giga LAN Ethernet module, 2-Ch, PCIe I/F

Safety Instructions

1. Please read these safety instructions carefully.
2. Please keep this User's Manual for later reference.
3. Please disconnect this equipment from AC outlet before cleaning. Use a damp cloth. Don't use liquid or sprayed detergent for cleaning. Use moisture sheet or clothe for cleaning.
4. For pluggable equipment, the socket-outlet shall near the equipment and shall be easily accessible.
5. Please keep this equipment from humidity.
6. Install this equipment on a stable surface. A drop or fall could cause injury.
7. The openings on the enclosure are for air convection and protect the equipment from overheating. **DO NOT COVER THE OPENINGS.**
8. Check the voltage of the power source when connecting the equipment to the power outlet. The power outlet socket should have grounded connection.
9. Place the power cord such a way that people cannot step on it. Do not place anything over the power cord.
10. All cautions and warnings on the equipment should be noted.
11. If the equipment is not used for long time, disconnect the equipment from mains to avoid being damaged by transient over-voltage.
12. Never pour any liquid into ventilation openings; this could cause fire or electrical shock.
13. Never open the equipment. For safety reasons, only qualified service personnel should open the equipment.
14. If one of the following situations arises, get the equipment checked by service personnel:
 - The power cord or plug is damaged.
 - Liquid has penetrated into the equipment.
 - The equipment has been exposed to moisture.
 - The equipment does not work well, or you cannot get it to work according to the user's manual.
 - The equipment has been dropped and damaged.
 - The equipment has obvious signs of breakage.
15. Do not leave this equipment in an environment where the storage temperature may go below -40 °C (-40 °F) or above 85 °C (185 °F). This could damage the equipment. The equipment should be in a controlled environment.
16. Caution: Danger of explosion if battery is incorrectly replaced. Replace only with the same or equivalent type recommended by the manufacturer, discard used batteries according to the manufacturer's instructions.
17. The sound pressure level at the operator's position according to IEC 704-1:1982 is no more than 70 dB (A).
18. **RESTRICTED ACCESS AREA:** The equipment should only be installed in a Restricted Access Area.
19. The product is intended to be supplied by an UL Listed power supply or dc source suitable for use at Tma 70 °C (158 °F) min. whose output meets PS2(or LPS),ES1(or SELV) and output is rated 9-36Vdc,4-1A min.,if need further assistance, please contact Advantech for further information.

Consignes de Sécurité

1. Lisez attentivement ces instructions de sécurité.

2. Conservez ce manuel de l'utilisateur pour référence ultérieure.
3. Débranchez cet appareil de toute prise secteur avant le nettoyage. Utilisez un chiffon humide. N'utilisez pas de détergents liquides ni en spray pour le nettoyage.
4. Pour les équipements enfichables, la prise de courant doit être située à proximité de l'équipement et doit être facilement accessible.
5. Gardez cet équipement à l'abri de l'humidité.
6. Placez cet équipement sur une surface fiable lors de son installation.
7. Les ouvertures de l'enceinte sont destinées à la convection de l'air. Protégez le matériel contre la surchauffe. **NE COUVREZ PAS LES OUVERTURES.**
8. Assurez-vous que la tension de la source d'alimentation est correcte avant de connecter l'équipement à la prise de courant. La prise de courant doit avoir une connexion mise à la terre.
9. Placez le cordon d'alimentation de sorte que personne ne puisse marcher dessus. Ne placez aucun objet sur le cordon.
10. Toutes les mises en garde et avertissements sur l'équipement doivent être notés.
11. Si l'équipement n'est pas utilisé pendant une longue période, débranchez-le de la source d'alimentation pour éviter tout dommage dû à une surtension transitoire.
12. Ne jamais verser de liquide dans une ouverture sous peine de provoquer un incendie ou un choc électrique.
13. Ne jamais ouvrir l'appareil. Pour des raisons de sécurité, cet équipement ne doit être ouvert que par du personnel qualifié (Par personne de compétence).
14. Si l'une des situations suivantes se produit, faites vérifier l'équipement par le personnel de service:
 - Le cordon d'alimentation ou la fiche est endommagé.
 - Un liquide a pénétré dans l'appareil.
 - L'équipement a été exposé à l'humidité.
 - L'équipement ne fonctionne pas bien ou vous ne pouvez pas le faire fonctionner conformément au manuel d'utilisation.
 - L'équipement est tombé et a été endommagé.
 - L'équipement présente des signes évidents de rupture.
15. Ne laissez pas cet équipement dans un environnement où la température de stockage peut être inférieure à -40 ° C (-40 ° F) ou supérieure à 85 ° C (185 ° F). Cela pourrait endommager l'équipement. L'équipement doit se trouver dans un environnement contrôlé.
16. Précaution: Risque d'explosion si la batterie n'est pas remplacée correctement. Remplacez uniquement par le même type ou un type équivalent recommandé par le fabricant, jetez les piles usagées conformément aux instructions du fabricant.
17. Le niveau de pression acoustique au poste de l'opérateur selon la CEI 704-1: 1982 n'est pas supérieur à 70 dB (A).
18. ZONE D'ACCÈS RESTREINT: L'équipement ne doit être installé que dans une zone d'accès restreint.
19. Ce produit est destiné à être alimenté par un bloc d'alimentation homologué UL adapté à une utilisation à T_{max} 70 ° C min. dont la sortie est conforme à PS2 (ou LPS), ES1 (ou SELV) et dont la sortie est nominale: 9-36Vdc, 4-1A min., si besoin d'aide supplémentaire, veuillez contacter Advantech pour plus d'informations.

Contents

Chapter 1	General Introduction	1
1.1	Introduction	2
1.2	Product Features.....	3
	1.2.1 General	3
	1.2.2 Display	3
	1.2.3 Ethernet	3
1.3	Chipset.....	3
	1.3.1 Functional Specification	3
	1.3.2 iManager/SUSI 4.0.....	4
1.4	Mechanical Specifications.....	5
	1.4.1 Dimensions	5
	Figure 1.1 ARK-2121 Mechanical Dimension Diagram	5
	1.4.2 Weight.....	5
1.5	Power Requirement	5
	1.5.1 System Power.....	5
	1.5.2 RTC Battery	5
1.6	Environment Specifications.....	6
	1.6.1 Operating Temperature.....	6
	1.6.2 Relative Humidity	6
	1.6.3 Storage Temperature.....	6
	1.6.4 Vibration During Operation	6
	1.6.5 Shock During Operation.....	6
	1.6.6 Safety.....	6
	1.6.7 EMC	6
Chapter 2	H/W Installation.....	7
2.1	Introduction	8
2.2	Jumpers	8
	2.2.1 Jumper Description	8
	2.2.2 Jumper List	9
	Table 2.1: Jumper List of Main Board.....	9
	2.2.3 Jumper Location	9
	Figure 2.1 Jumper Layout Diagram	9
	2.2.4 Jumper Setting.....	9
2.3	Connectors.....	10
	2.3.1 ARK-2121L External I/O Connectors	10
	Figure 2.2 ARK-2121L I/O Connectors Diagram	10
	Figure 2.3 COM Connector.....	10
	Table 2.2: COM Connector Pin Assignments.....	11
	Figure 2.4 Ethernet Connector	11
	Table 2.3: Ethernet Connector Pin Assignments.....	11
	Figure 2.5 Audio Connector	12
	Table 2.4: Audio Connector Pin Assignments	12
	Figure 2.6 USB Connector.....	12
	Table 2.5: USB Connector.....	12
	Figure 2.7 VGA Connector	12
	Table 2.6: VGA Connector Pin Assignments.....	12
	Figure 2.8 Power Input Connector.....	13
	Table 2.7: Power Connector Pin Assignments	13
	Figure 2.9 Power Button	13
	Figure 2.10 LED Indicators	13
2.4	Installation	14
	2.4.1 HDD Installation.....	14

	2.4.2	Memory Installation.....	15
	2.4.3	mSATA Installation.....	17
2.5		Installing Mounting Brackets.....	18

Chapter 3 BIOS Settings 21

3.1	BIOS Setup.....	22
	Figure 3.1 Initial Setup Program Screen.....	22
3.2	Entering Setup.....	22
3.3	Main Setup.....	22
	Figure 3.2 Main Setup Screen.....	23
3.3.1	System Date / System Time.....	23
3.4	Advanced BIOS Features Setup.....	23
	Figure 3.3 Advanced BIOS Features Setup Screen.....	24
3.4.1	ACPI Settings.....	24
	Figure 3.4 ACPI Settings.....	24
3.4.2	Super I/O Configuration.....	25
3.4.3	Embedded Controller Configuration.....	26
3.4.4	S5 RTC Wake Settings.....	26
3.4.5	Serial Port Console Redirection.....	27
3.4.6	CPU Configuration.....	28
	Figure 3.5 Intel Fast Flash Standby.....	28
3.4.7	PPM Configuration.....	29
3.4.8	IDE Configuration.....	30
3.4.9	CSM Configuration.....	31
3.4.10	Trusted Computing.....	32
3.4.11	USB Configuration.....	32
3.5	Security Configuration.....	33
3.5.1	Chipset Configuration.....	34
3.5.2	North Bridge.....	35
3.5.3	Intel IGD Configuration.....	36
3.5.4	South Bridge.....	37
3.5.5	Azalia HD Audio.....	38
3.5.6	USB Configuration.....	39
3.5.7	PCI Express Configuration.....	40
3.6	Boot Settings.....	41
3.7	Security Setup.....	42
3.8	Save & Exit.....	43

Appendix A Watchdog Timer Sample Code 45

A.1	EC Watchdog Timer Sample Code.....	46
-----	------------------------------------	----

Chapter 1

General Introduction

This chapter details background information on the ARK-2121 series.

1.1 Introduction

ARK-2121 is an intelligent, fanless embedded system powered by Intel® Celeron™ J1900 Quad Core low power processor with multiple I/O interfaces. The new generation Intel® Celeron™ processor brings a 300% improvement to processing power and a 300% improvement to graphics performance when compared to previous generation Intel® Atom™ processors. These low-power platforms provide energy-efficient and environmentally responsible solutions. These solutions are excellent choices for factory automation, machine automation, kiosks, and self-service applications. They operate reliably in -20 ~ 70 °C (-4 ~ 158 °F) environments.

Rugged Multi-functional Design

ARK-2121 is powered by Intel® Celeron™ J1900 2.0GHz Quad core processors in an Advantech, rugged-design embedded box PC. All models are fanless, and deliver various features including wide-input power supplies from 9-36VDC, diverse expandability options, and structural strengthening. ARK-2121L enlarges the surface of the top cover and conductive cylinder to create maximum cooling effects for optimized cooling efficiency. It also supports diverse I/O interfaces — up to 4x USB, 2x GbE, 4x COM, and a high capacity 2.5” HDD up to 1 TB. The RS-232/422/485 COM port mode can easily be changed using BIOS settings.

Multiple Display Support

ARK-2121 supports two display types — VGA and HDMI display. The graphic engine is DirectX 11.1, H/W format decode/Acceleration, MPEG2 (H/W acceleration), H.264/VC1/ WMV9 (H/W Decode/Acceleration). ARK-2121 supports dual independent displays.

Built in Intelligent Management Tools — Advantech iManager & SUSIAccess

Advantech iManager/SUSI 4.0 provides a valuable suite of programmable APIs such as multi-level watchdog, hardware monitor, system restore, and other user-friendly interfaces. iManager is an intelligent self-management cross platform tool that monitors system statuses for problems and takes action in the event of an abnormality. iManager/SUSI 4.0 offers a boot up guarantee in critical, low temperature environments so systems can automatically recover when voltages dip. iManager/SUSI 4.0 makes the whole system more reliable and more intelligent. ARK-2121L also supports Advantech’s own SUSIAccess, which provides easy remote management so users can monitor, configure, and control a large number of terminals to make maintenance and system recovery simpler.

1.2 Product Features

1.2.1 General

- **CPU:** Intel® Celeron™ Processor J1900 2.0GHz
- **System Chipset:** Intel® Celeron J1900 SOC
- **BIOS:** AMI 16 Mbit Flash BIOS
- **System Memory:** One DDR3L SODIMM. DDR3L 1333MHz up to 8 GB
- **Watchdog Timer:** Single chip Watchdog 255-level interval timer, setup by software
- **I/O Interface:** 2x RS232, 2x RS232/422/485
- **USB:** 3x USB 2.0, 1x USB 3.0 compliant ports
- **Audio:** High Definition Audio (HD), Line-in, Line out, Mic-in
- **Storage:** 1x mSATA and 1 x high capacity 2.5" SATA HDD (up to 12.5mm height)
- **Expansion Interface:**
 - Supports 1x MiniPCIe with SIM holder
 - Supports 1x iDoor expansion
- **Software API:** Advantech iManager/SUSI 4.0 and SUSIAccess - Remote Device Management technology

1.2.2 Display

- **Controller:** Intel® Celeron J1900
- **Resolution:**
 - VGA: Supports up to 2048 x 1152
 - HDMI: Supports up to 1080P @ 60Hz, Supports HDMI 1.4a
- **Dual Display:** VGA+HDMI

1.2.3 Ethernet

- **Chipset:**
 - LAN1 Intel i210
 - LAN2 Intel i210
- **Speed:** 1000 Mbps
- **Interface:** 2x RJ45
- **Standard:** Compliant with IEEE 802.3, IEEE 802.3u, IEEE 802.3x, IEEE 802.3y, IEEE 802.ab.

1.3 Chipset

1.3.1 Functional Specification

1.3.1.1 Processor

Processor	Intel® Celeron™ Processor J1900 Intel® Celeron™ J1900 at 2.0GHz, with 2MB L2 Cache Manufacturing Technology 22nm
Memory	Supports DDR3L 1333MHz up to 8GB 1x 204-pin SODIMM socket type

1.3.1.2 Chipset

Internal Graphics Features	<ul style="list-style-type: none"> ■ DirectX 11.1 and OpenGL 3.0 ■ Display Ports VGA + HDMI, HDMI 1.4a ■ Supports HDCP 1.3
Video Accelerator	<ul style="list-style-type: none"> ■ H/W accelerated video decode ■ Video decoder: Support MPEG4, VC1, WMV9, H.264 ■ Supports DVD, Blu-ray, and HD video
SATA Interface	<ul style="list-style-type: none"> ■ Supports several optional sections of Serial ATA II: Extensions to Serial ATA 1.0 Specification, Revision 1.0 ■ Supports SATA transfers to 300 Mbytes/sec. ■ Supports mSATA socket
USB Interface	<ul style="list-style-type: none"> ■ USB host interface with support for 1x USB 3.0 and 3x USB 2.0 ports ■ All ports are High-Speed, Full-Speed, and Low-Speed capable ■ Supports legacy keyboard/mouse software
BIOS	<ul style="list-style-type: none"> ■ AMI 16Mb Flash BIOS via SPI

1.3.1.3 Others

Serial ports	<ul style="list-style-type: none"> ■ COM1, COM2: Supports RS-232 ■ COM3 ~ COM4: Supports RS-232/422/485 and change mode under BIOS setting <p>** COM3 ~ COM4 RS-485 supports Auto flow control.</p> <p>COM connector: D-SUB CON. 9P</p>
Ethernet	<p>LAN1 Intel i210, LAN2 Intel i210</p> <ul style="list-style-type: none"> ■ Compliant with IEEE 802.3, IEEE 802.3u, IEEE 802.3x, IEEE 802.3y, IEEE 802.ab. ■ Support 10/100/1000 Mbps. <p>LAN Connectors: Phone Jack RJ45 8P 90D(F)</p>
Audio	<p>Audio Codec: Realtek ALC888S:</p> <ul style="list-style-type: none"> ■ Compliant with HD Audio specifications ■ Supports 16/20/24-bit DAC and 16/20/24-bit ADC resolution ■ Supports: Line-out, Line-in, Mic-in <p>Audio Connectors: Ear Phone Jack * 3</p>
Battery backup	<ul style="list-style-type: none"> ■ BATTERY 3V/210 mAh with WIRE x 1

1.3.2 iManager/SUSI 4.0

Sequence control	Supported
Watchdog timer	Multi Level WDT Programmable 1-255 sec / min
Hardware monitor	CPU Temperature / input Current / input Voltage
Power saving	Deep sleep S5 mode
System information	Running HR / Boot record

1.4 Mechanical Specifications

1.4.1 Dimensions

264 x 68.4 x 133 mm (10.4 x 2.69 x 5.2 in)

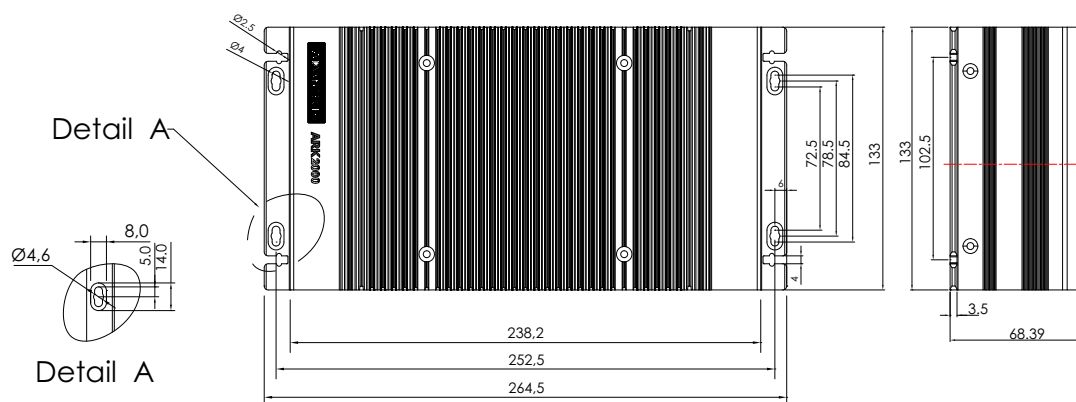

Figure 1.1 ARK-2121 Mechanical Dimension Diagram

1.4.2 Weight

2.3 kg (5.06 lb)

1.5 Power Requirement

1.5.1 System Power

- **Minimum power input:**
 - ARK-2121L : DC 9 - 36V, 4A - 1A

1.5.2 RTC Battery

- Lithium 3 V/210 mAh

1.6 Environment Specifications

1.6.1 Operating Temperature

- With Industrial Grade SSD/mSATA: -20 ~ 70 °C (-4 ~158 °F), with air flow, speed=0.7 m/sec
- With 2.5-inch hard disk 0 ~ 45 °C (32 ~113 °F), with air flow, speed=0.7 m/sec

1.6.2 Relative Humidity

- 95% @ 40 °C (non-condensing)

1.6.3 Storage Temperature

- -40 ~ 85 °C (-40 ~ 185 °F)

1.6.4 Vibration During Operation

- When the system is equipped with SSD/mSATA: 3Grms, IEC 60068-2-64, random, 5 ~ 500 Hz, 1hr/axis, x,y,z 3 axes.

1.6.5 Shock During Operation

- When the system is equipped with SSD/mSATA: 30G, IEC 60068-2-27, half sine, 11 ms duration.

1.6.6 Safety

- UL, CB, CCC, BSMI

1.6.7 EMC

- CE, FCC, CCC, BSMI

Chapter 2

H/W Installation

This chapter details external I/O and the installation of ARK-2121 hardware.

2.1 Introduction

The following sections show the internal jumper settings and the external connector pin assignments for different applications.

2.2 Jumpers

2.2.1 Jumper Description

You may configure ARK-2121 to match the needs of your application by setting jumpers. A jumper is a metal bridge used to close an electric circuit. It consists of two metal pins and a small metal clip (often protected by a plastic cover) that slides over the pins to connect them. To close a jumper, you connect the pins with the clip. To open a jumper, you remove the clip. Sometimes a jumper will have three pins, labeled 1, 2 and 3. In this case you would connect either pins 1 and 2, or 2 and 3.

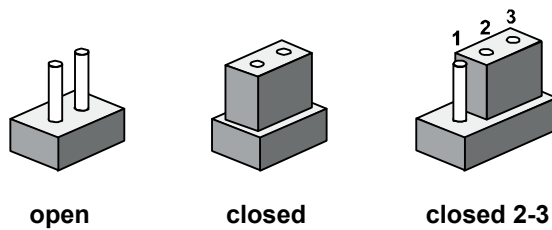

The jumper settings are schematically depicted in this manual as follows.

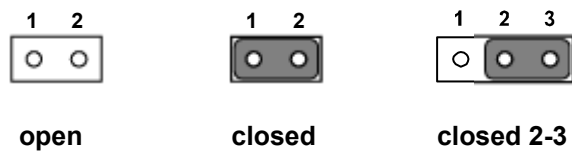

A pair of needle-nose pliers may be helpful when working with jumpers. If you have any doubts about the best hardware configuration for your application, contact your local distributor or sales representative before you make any changes. Generally, you simply need a standard cable to make most connections.

2.2.2 Jumper List

Table 2.1: Jumper List of Main Board

J2	Auto Power On Setting
SW2	Clear CMOS

2.2.3 Jumper Location

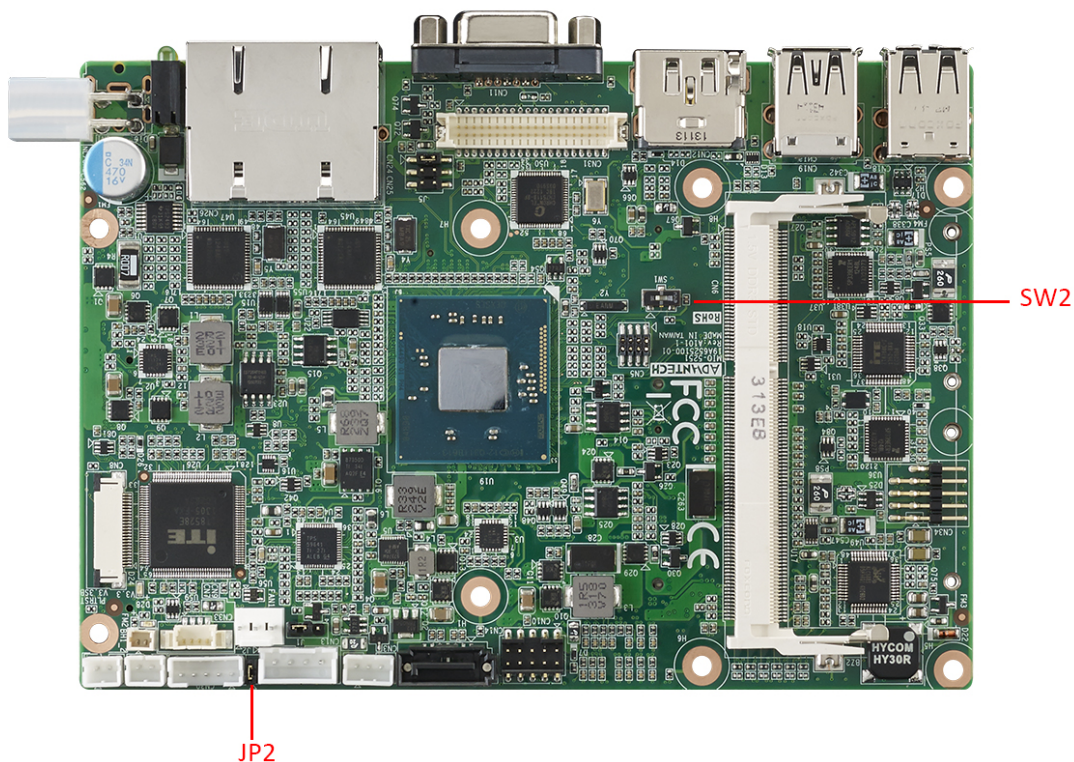

Figure 2.1 Jumper Layout Diagram

2.2.4 Jumper Setting

On the Mother Board

J2	Auto Power On Setting
Part Number	1653002101
Footprint	HD_3x2P_79_D
Description	PIN HEADER 2*1P 180D(M)SQUARE 2.0mm DIP W/O Pb
Setting	Function
NL	Power On by power button
(1-2)*	Auto Power On (default)



SW2	Clear CMOS
Part Number	1600000071
Footprint	SW_3P_CJS-1201TA1
Description	CJS-1201TA1

Setting	Function
1*	NC (Default)
2	RTC_TEST#
3	GND (Clear CMOS)

2.3 Connectors

2.3.1 ARK-2121L External I/O Connectors

ARK-2121L:

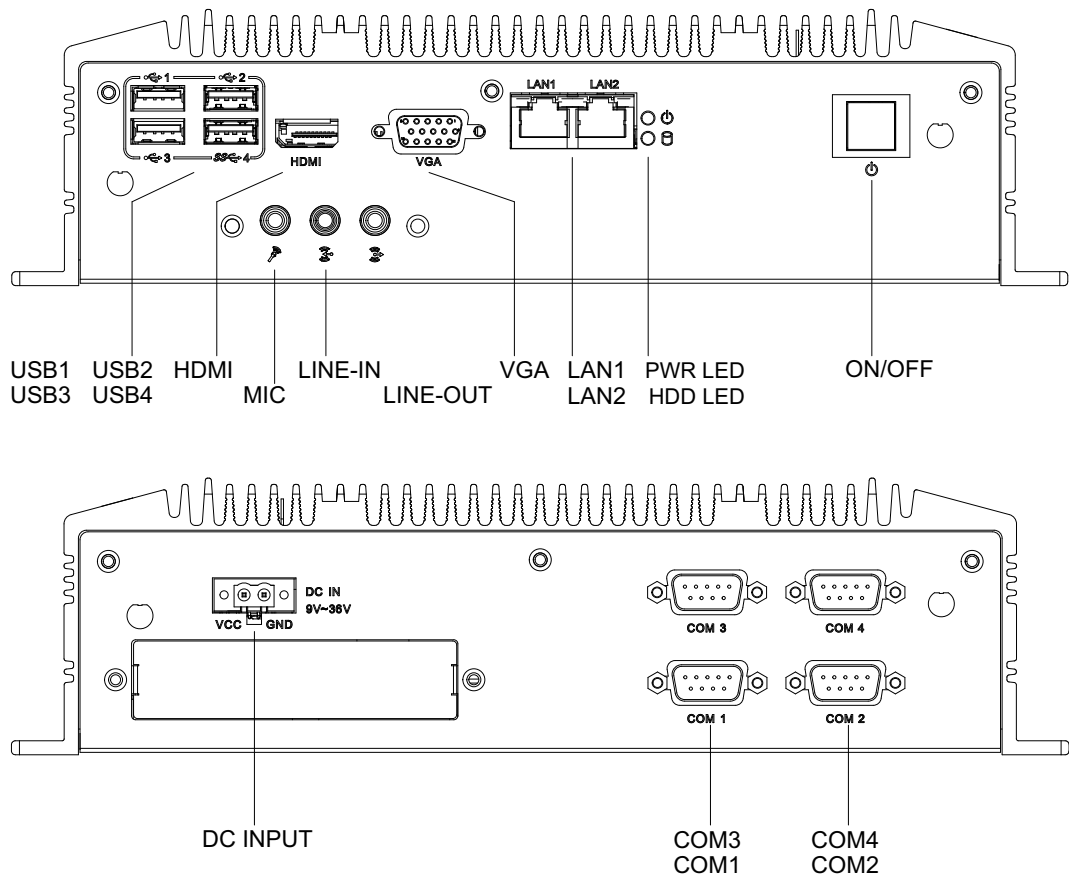

Figure 2.2 ARK-2121L I/O Connectors Diagram

2.3.1.1 COM Connector

ARK-2121L provides four D-sub 9-pin connectors, which offers RS-232 or RS232/422/485 serial communication interface ports. The default setting is RS-232, if you want to use RS-422/485, you can find the BIOS setting in Chapter 3.4.2 for ARK-2121L.

The RS-422/485 mode of ARK-2121L COM3~COM4 can be supported via BIOS settings. The setting is under Advanced BIOS Features Setup -> Super I/O Configuration.

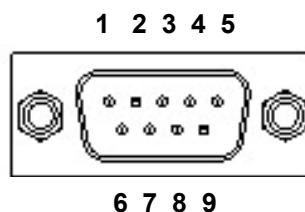

Figure 2.3 COM Connector

Table 2.2: COM Connector Pin Assignments

	RS-232	RS-422	RS-485
Pin	Signal Name	Signal Name	Signal Name
1	DCD	Tx-	DATA-
2	RxD	Tx+	DATA+
3	TxD	Rx+	NC
4	DTR	Rx-	NC
5	GND	GND	GND
6	DSR	NC	NC
7	RTS	NC	NC
8	CTS	NC	NC
9	RI	NC	NC

Note! NC represents “No Connection”.



2.3.1.2 Ethernet Connector (LAN)

ARK-2121L is equipped with two Ethernet controllers that are fully compliant with IEEE 802.3u 10/100/1000 Mbps CSMA/CD standards. LAN1, LAN2 are all equipped with Intel i210 Ethernet controller. The Ethernet port provides a standard RJ-45 jack connector with LED indicators on the front side to show its Active/Link status (Green LED) and Speed status (Yellow LED).

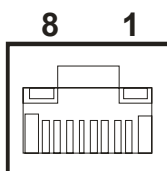
**Figure 2.4 Ethernet Connector****Table 2.3: Ethernet Connector Pin Assignments**

Pin	10/100/1000BaseT Signal Name
1	TX+
2	TX-
3	RX+
4	MDI2+
5	MDI2-
6	RX-
7	MDI3+
8	MDI3-

2.3.1.3 Audio Connector

ARK-2121L offers stereo audio ports by three phone jack connectors of Line_Out, Line_In, Mic_In. The audio chip is controlled by ALC888S, and it's compliant with Azalea standards.

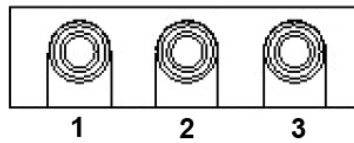

Figure 2.5 Audio Connector

Table 2.4: Audio Connector Pin Assignments

Pin	Audio Signal Name
1	Mic_In
2	Line_In
3	Line_Out

2.3.1.4 USB Connector

ARK-2121L provides four USB interface connectors. The USB connectors are used to connect any device that conforms to the USB interface. Most digital devices conform to this standard. The USB interface supports Plug and Play functionality.

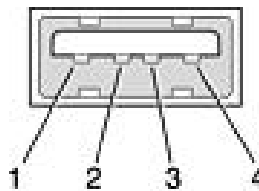

Figure 2.6 USB Connector

Table 2.5: USB Connector

Pin	Signal name	Pin	Signal name
1	VCC	2	USB_data-
3	USB_data+	4	GND

2.3.1.5 VGA Connector

The ARK-2121L provides a high resolution VGA interface connected by a D-sub 15-pin connector to support a VGA CRT monitor. It supports display resolutions of up to 2048 x 1152.

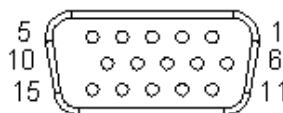

Figure 2.7 VGA Connector

Table 2.6: VGA Connector Pin Assignments

Pin	Signal Name	Pin	Signal Name
1	Red	2	Green

3	Blue	4	NC
5	GND	6	GND
7	GND	8	GND
9	NC	10	GND
11	NC	12	DDAT
13	H-SYNC	14	V-SYNC
15	DCLK		

2.3.1.6 Power Input Connector

ARK-2121L comes with a two-pins header that carries 9 ~ 36 VDC external power input.

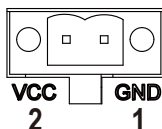

Figure 2.8 Power Input Connector

Table 2.7: Power Connector Pin Assignments

Pin	Signal Name
1	GND
2	+9 - 36 VDC

2.3.1.7 Power ON/OFF Button

ARK-2121L comes with a Power On/Off button, that supports dual functions of Soft Power - On/Off (Instant off or Delay 4 Second), and Suspend.

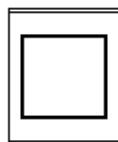

Figure 2.9 Power Button

2.3.1.8 LED Indicators

There are two LEDs on ARK-2121L front metal face plate for indicating system status: PWR LED is for power status; and HDD LED is for HDD & flash disk status.

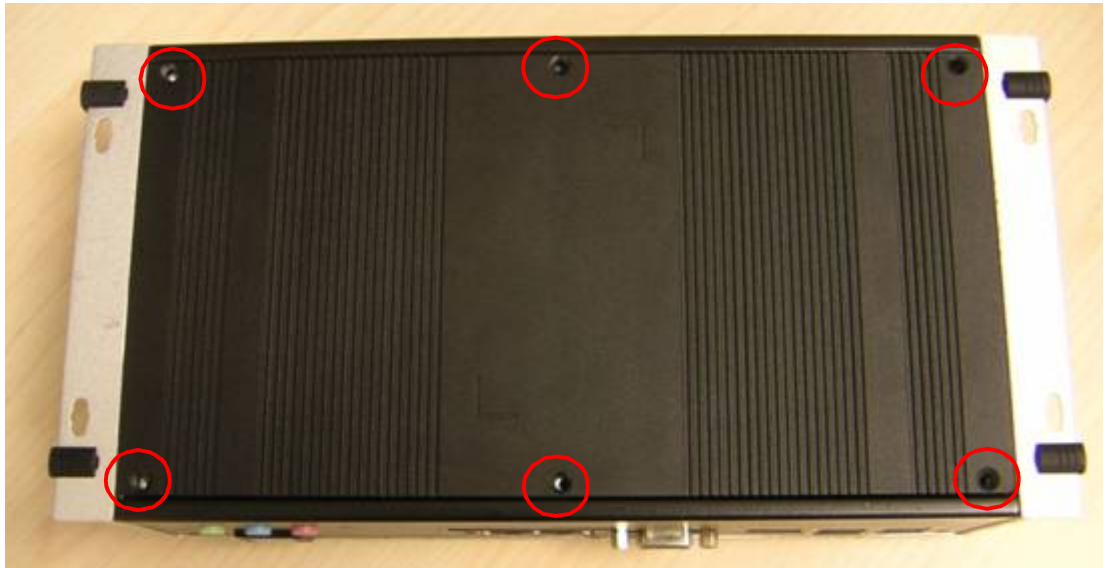

Figure 2.10 LED Indicators

2.4 Installation

2.4.1 HDD Installation

1. Unscrew the six screws on the bottom cover.



2. Slide the 2.5" SATA HDD into the HDD bay on the bottom cover.

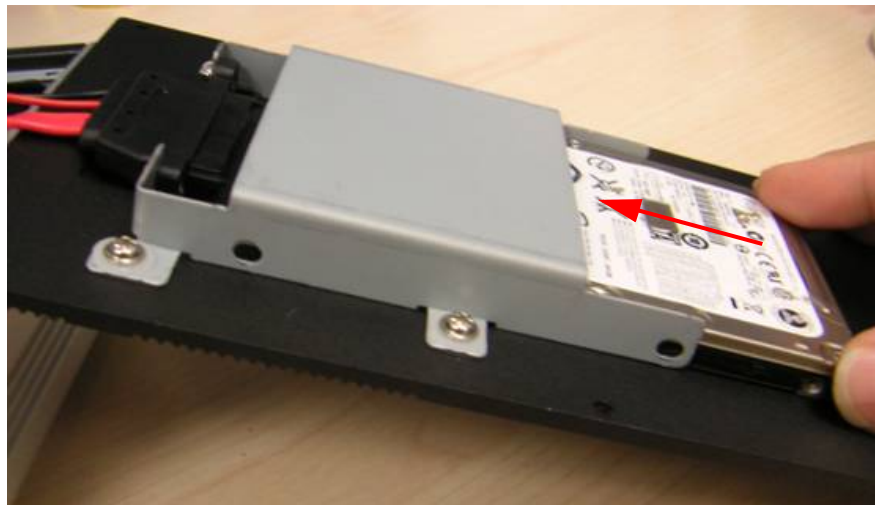

3. Screw the four screws on the side of HDD bracket. The screws are used to fix the HDD to the bracket. (The screws are in the accessory box.)

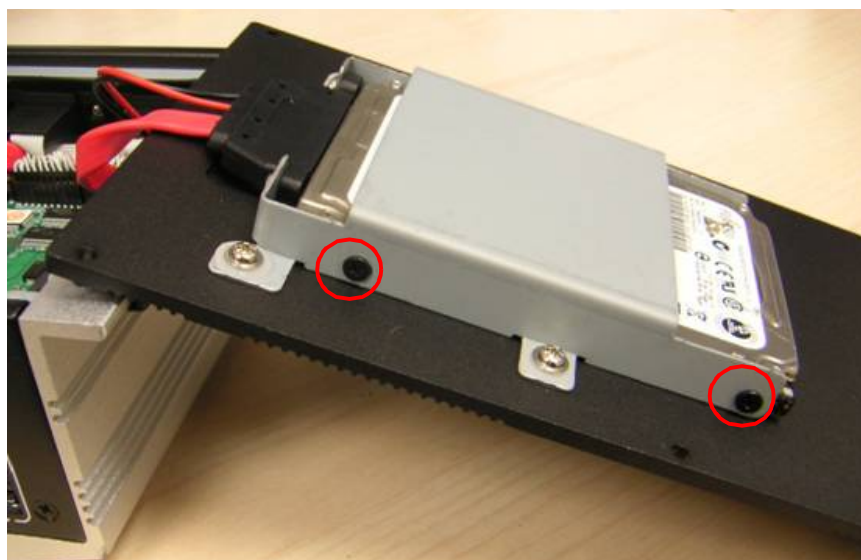

4. Return the bottom cover and screws.

2.4.2 Memory Installation

1. Unscrew the four screws on the top cover.



2. Unscrew the four screws on the right and left side of top cover.



3. Remove the top cover.

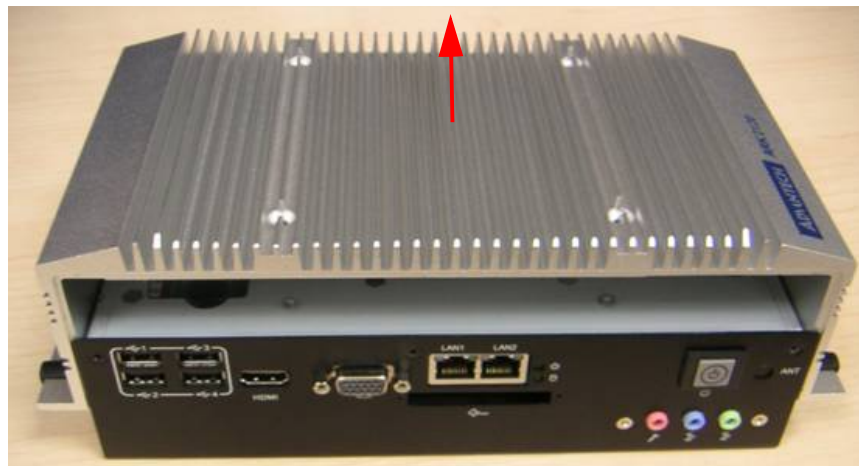

4. Install DDR3L memory in to the system.



5. Return the top chassis.

2.4.3 mSATA Installation

1. Unscrew the six screws on the bottom cover.

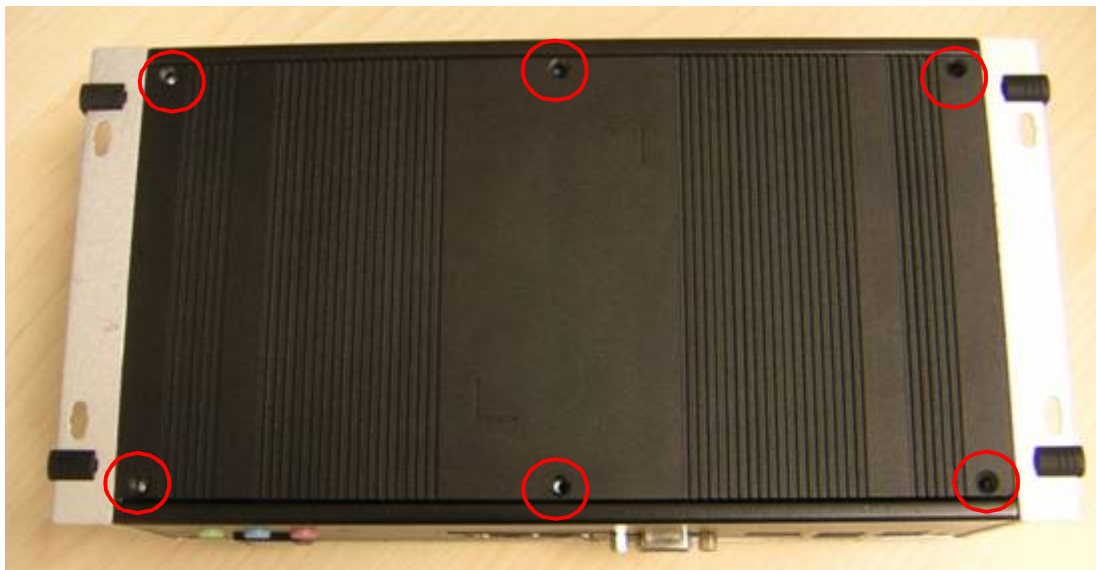

2. Put the mSATA module in mSATA slot (CN16).

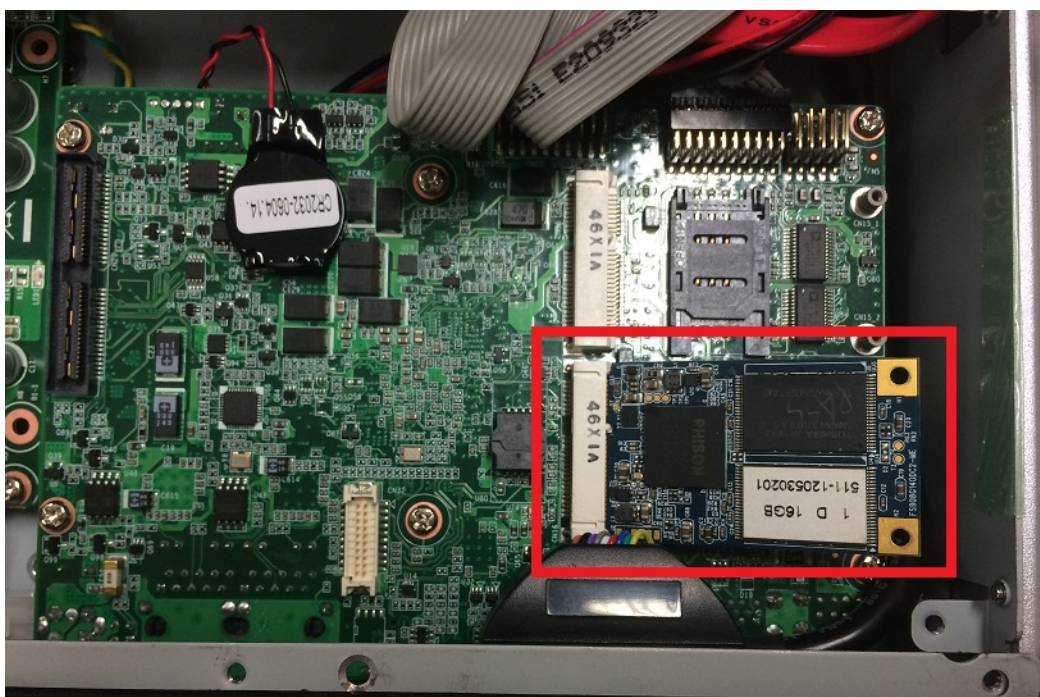

3. Screw 2 screws on the mSATA module.



2.5 Installing Mounting Brackets

Desktop

Use 4 pcs of screws M3x6L screws to fix ARK-2121L unit.

Bureau

Utilisez 4 pièces de vis M3x6L pour fixer l'unité ARK-2121L.

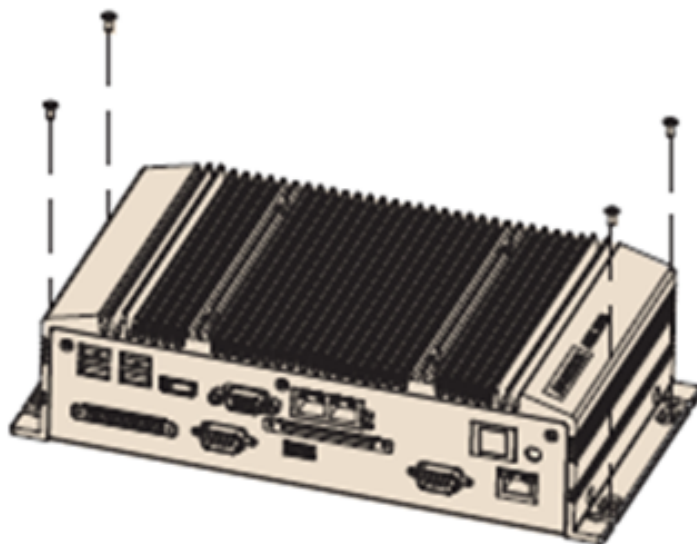

Wall-mounted (I/O toward up and down)

Use 4 pcs of screws M3x6L screws to fix ARK-2121L unit.

Fixé au mur (I/O vers le haut et vers le bas)

Utilisez 4 pièces de vis M3x6L pour fixer l'unité ARK-2121L.

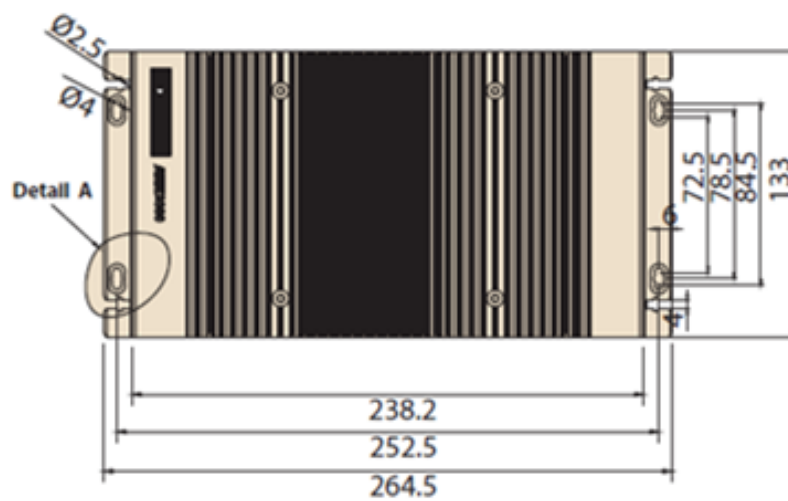

Chapter 3

BIOS Settings

3.1 BIOS Setup

With the AMIBIOS setup program, you can modify BIOS settings and control the various system features. This chapter describes the basic navigation of the ARK-2121 BIOS setup screens.

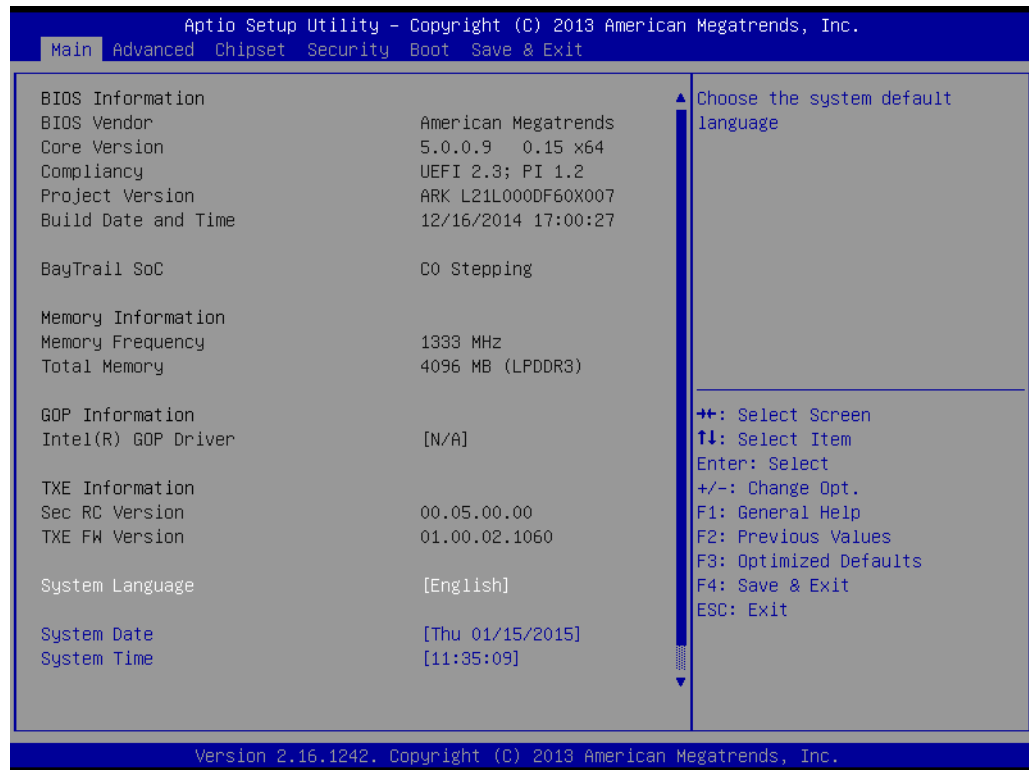

Figure 3.1 Initial Setup Program Screen

AMI's BIOS ROM has a built-in Setup program that allows users to modify the basic system configuration. This information is stored in flash ROM so it retains the Setup information when the power is turned off.

3.2 Entering Setup

Turn on the computer and then press <F2> or to enter the Setup menu.

3.3 Main Setup

When users first enter the BIOS Setup Utility, users will enter the Main setup screen. Users can always return to the Main setup screen by selecting the Main tab. There are two Main Setup options. They are described in this section. The Main BIOS Setup screen is shown below.

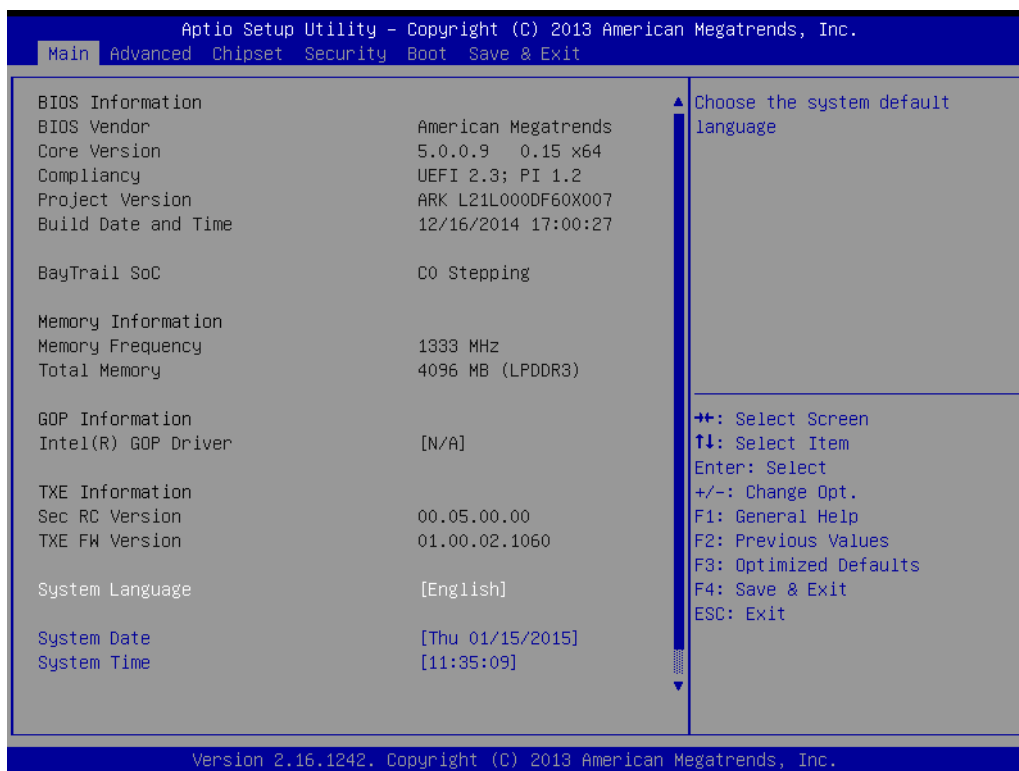

Figure 3.2 Main Setup Screen

The Main BIOS setup screen has two main frames. The left frame displays all the options that can be configured. Grayed-out options cannot be configured; options in blue can. The right frame displays the key legend.

Above the key legend is an area reserved for a text message. When an option is selected in the left frame, it is highlighted in white. Often a text message will accompany it.

3.3.1 System Date / System Time

Use this option to change the system time and date. Highlight System Time or System Date using the <Arrow> keys. Enter new values through the keyboard. Press the <Tab> key or the <Arrow> keys to move between fields. The date must be entered in MM/DD/YY format. The time must be entered in HH:MM:SS format.

3.4 Advanced BIOS Features Setup

Select the Advanced tab from the ARK-2121 setup screen to enter the Advanced BIOS Setup screen. You can select any of the items in the left frame of the screen, such as CPU Configuration, to go to the sub menu for that item. You can display an Advanced BIOS Setup option by highlighting it using the <Arrow> keys. All Advanced BIOS Setup options are described in this section. The Advanced BIOS Setup screens are shown below. The sub menus are described on the following pages.

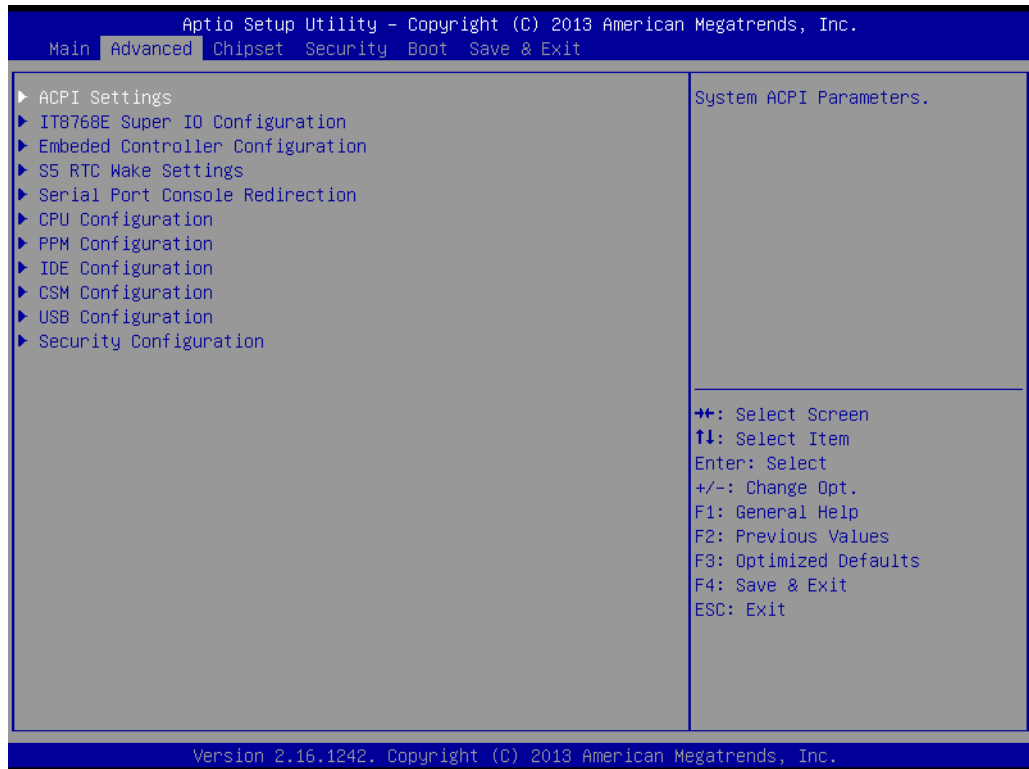

Figure 3.3 Advanced BIOS Features Setup Screen

3.4.1 ACPI Settings

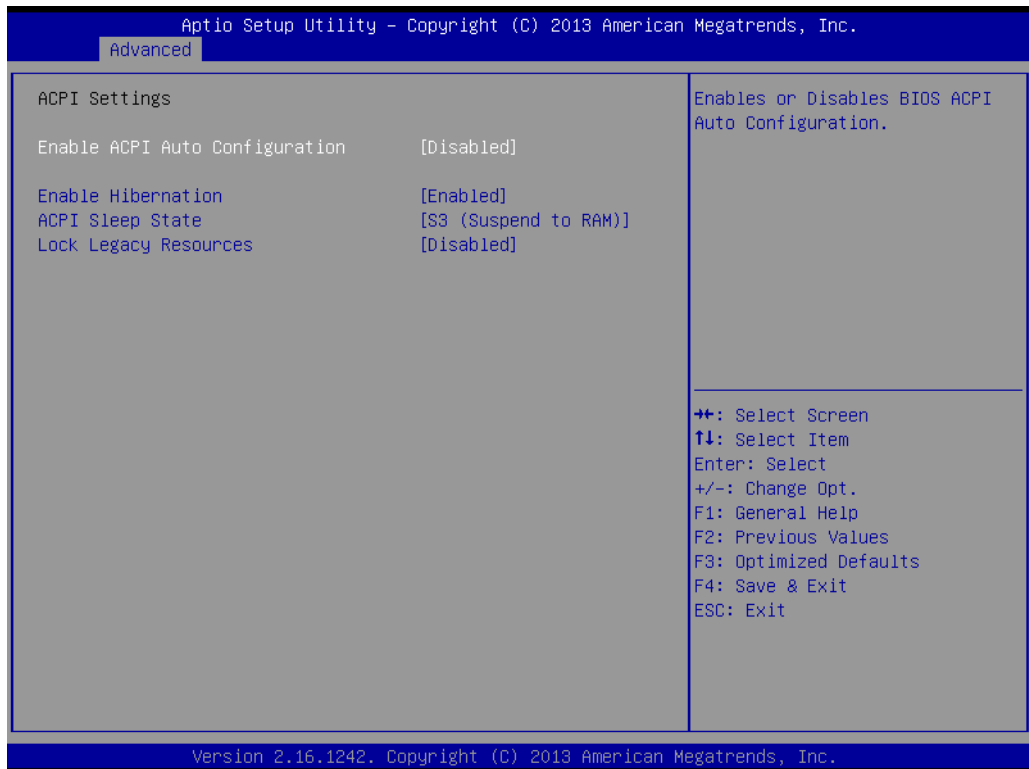
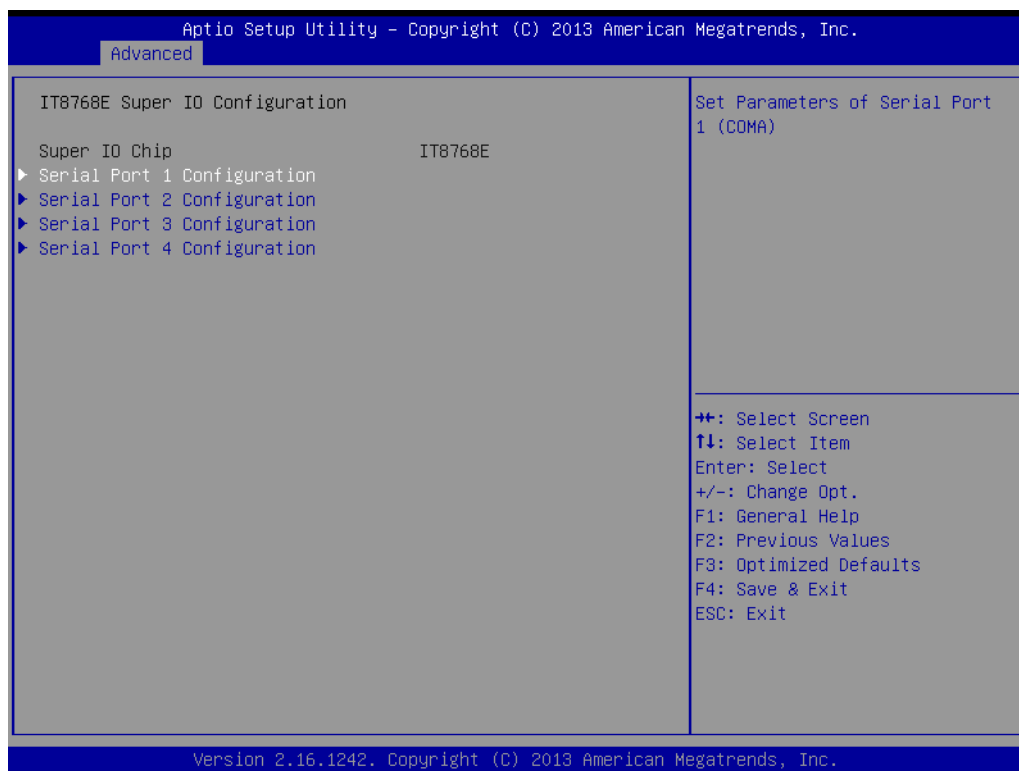

Figure 3.4 ACPI Settings

- **Enable ACPI Auto Configuration**
This item allows users to enable or disable BIOS ACPI auto configuration.
- **Enable Hibernation**
This item allows users to enable or disable hibernation.
- **ACPI Sleep State**
This item allows users to set the ACPI sleep state.
- **Lock Legacy Resources**
This item allows users to lock legacy devices' resources.

3.4.2 Super I/O Configuration



- **Serial Port 1 Configuration**
Set Parameters of Serial Port 1 (COMA).
- **Serial Port 2 Configuration**
Set Parameters of Serial Port 2 (COMB).
- **Serial Port 3 Configuration**
Set Parameters of Serial Port 3 (COMC).
- **Serial Port 4 Configuration**
Set Parameters of Serial Port 4 (COMD).

3.4.3 Embedded Controller Configuration

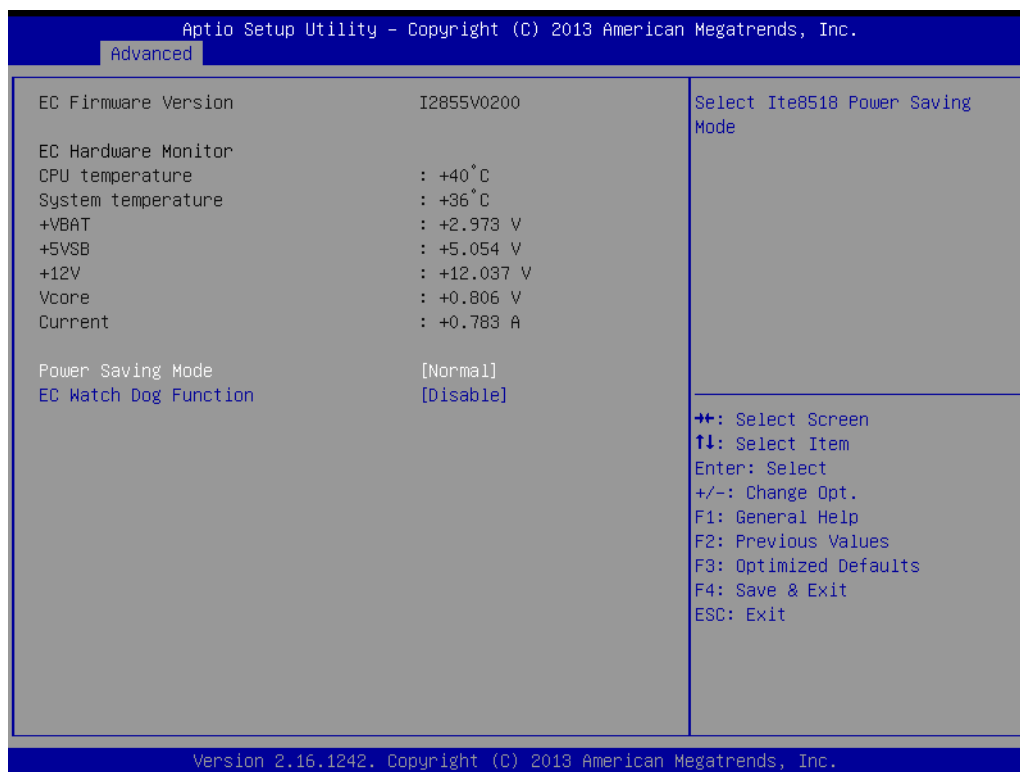

- **EC Hardware Monitor**
This page display all information about system Temperature/Voltage/Current.
- **EC Power Saving Mode**
This item allows users to set board's power saving mode when off.
- **EC Watch Dog Function**
This item allows users to select EC watchdog timer.

3.4.4 S5 RTC Wake Settings

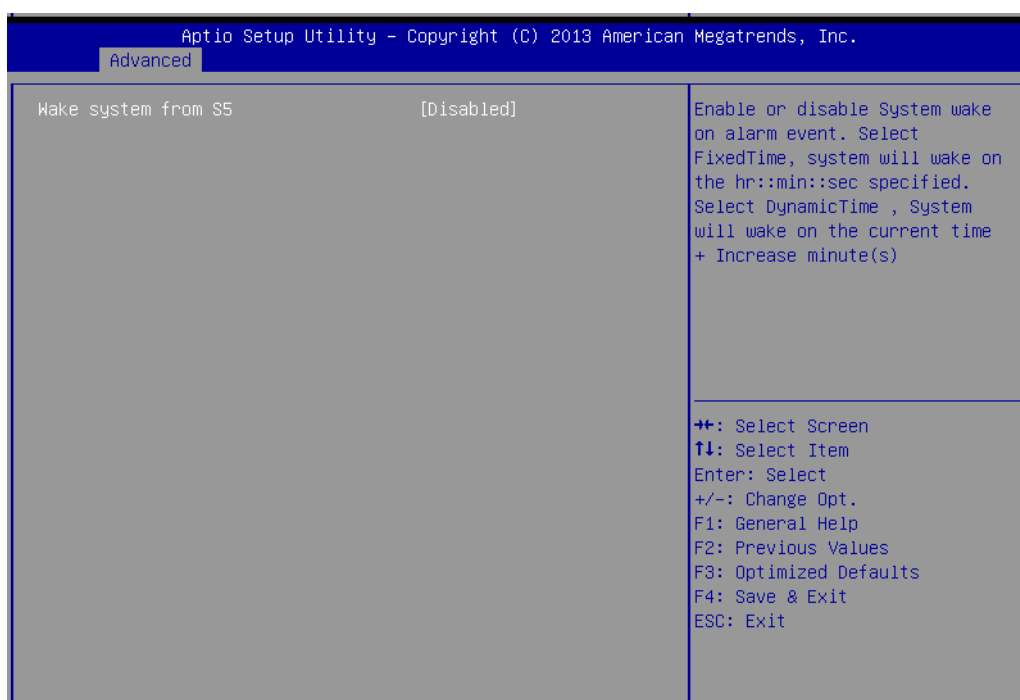

- **Wake system from S5**
Enable or disable System wake on alarm event. Select FixedTime, system will wake on the hr:min:sec specified.

3.4.5 Serial Port Console Redirection

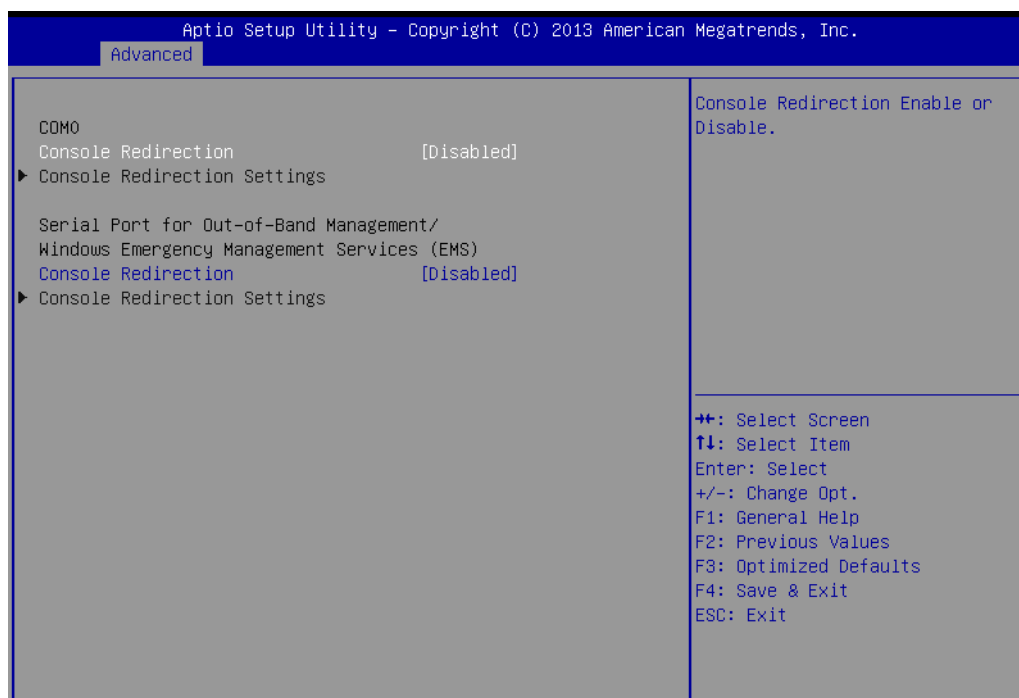

- **Console Redirection**
This item allows users to enable or disable console redirection for Microsoft Windows Emergency Management Services (EMS).
- **Console Redirection**
This item allows users to configuration console redirection detail settings.

3.4.6 CPU Configuration

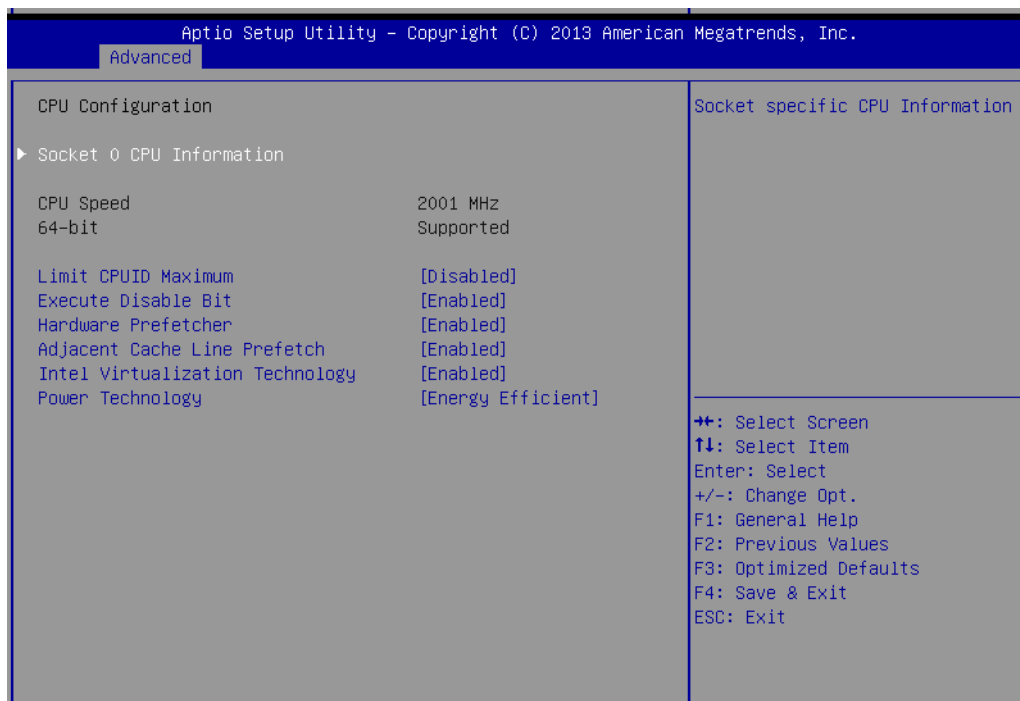
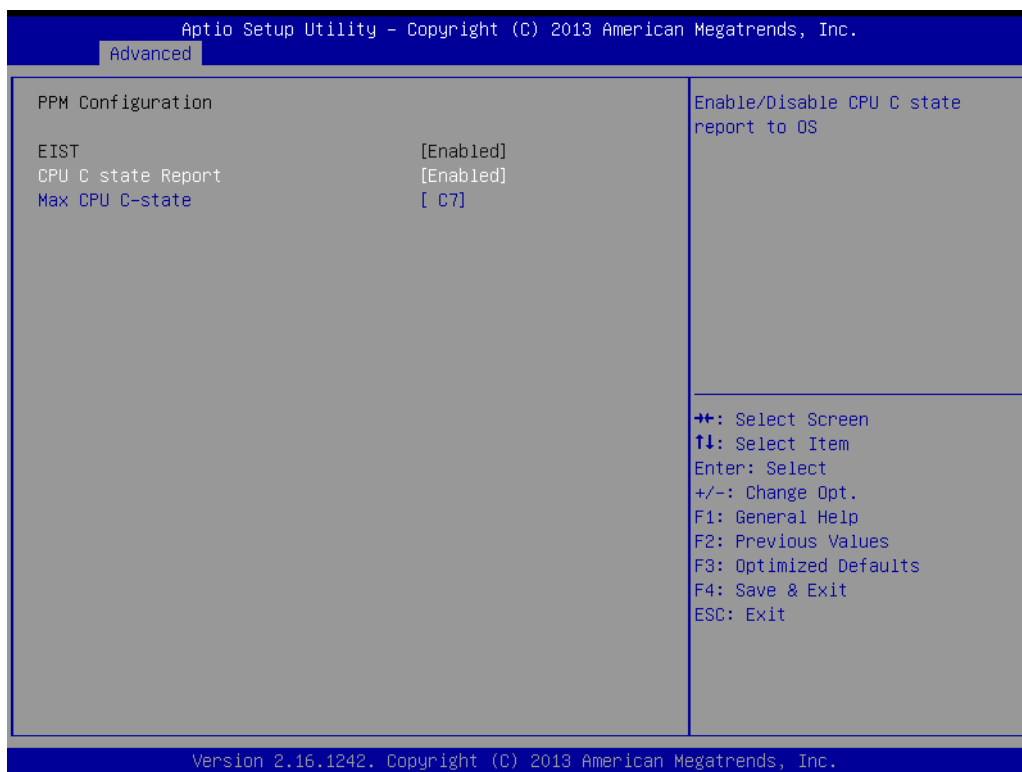

Figure 3.5 Intel Fast Flash Standby

- **Limit CPUID Maximum**
Disabled for Windows XP.
- **Execute Disable Bit**
XD can prevent certain classes of malicious buffer overflow attacks when combined with a supporting OS (Windows Server 2003 SP1, Windows XP SP2, SuSE Linux 9.2, RedHat Enterprise 3 Update 3.)
- **Hardware Prefetcher**
Enable the mid level cache(L2) streamer prefetcher.
- **Adjacent Cache Line Prefetch**
Enable the mid level cache(L2) prefetching of adjacent cache lines.
- **Intel Virtualization Technology**
When enabled, a VMM can utilize the additional hardware capabilities provided by Vanderpool Technology.
- **Power Technology**
Enable the power management features.

3.4.7 PPM Configuration



- **CPU C state Report**
Enable/Disable CPU C state report to OS.
- **Max CPU C-state**
This option controls the Max C state that the processor will support.

3.4.8 IDE Configuration

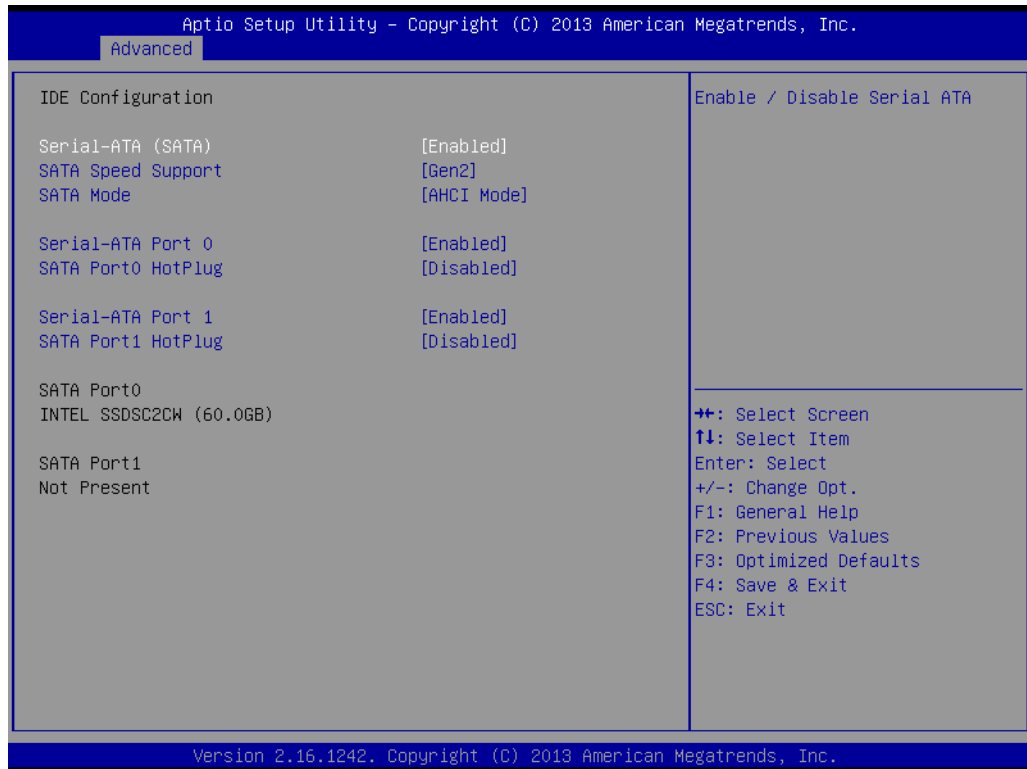

- **Serial-ATA (SATA)**
Enable / Disable Serial ATA.
- **SATA Speed Support**
SATA Speed Support Gen1 or Gen2.
- **SATA Mode**
Select IDE / AHCI.
- **Serial-ATA Port 0 / Port1**
Enable / Disable Serial ATA Port0 / Port1.
- **SATA Port 0 / Port1 HotPlug**
Enable / Disable SATA Port0 / Port1 hotplug function.

3.4.9 CSM Configuration

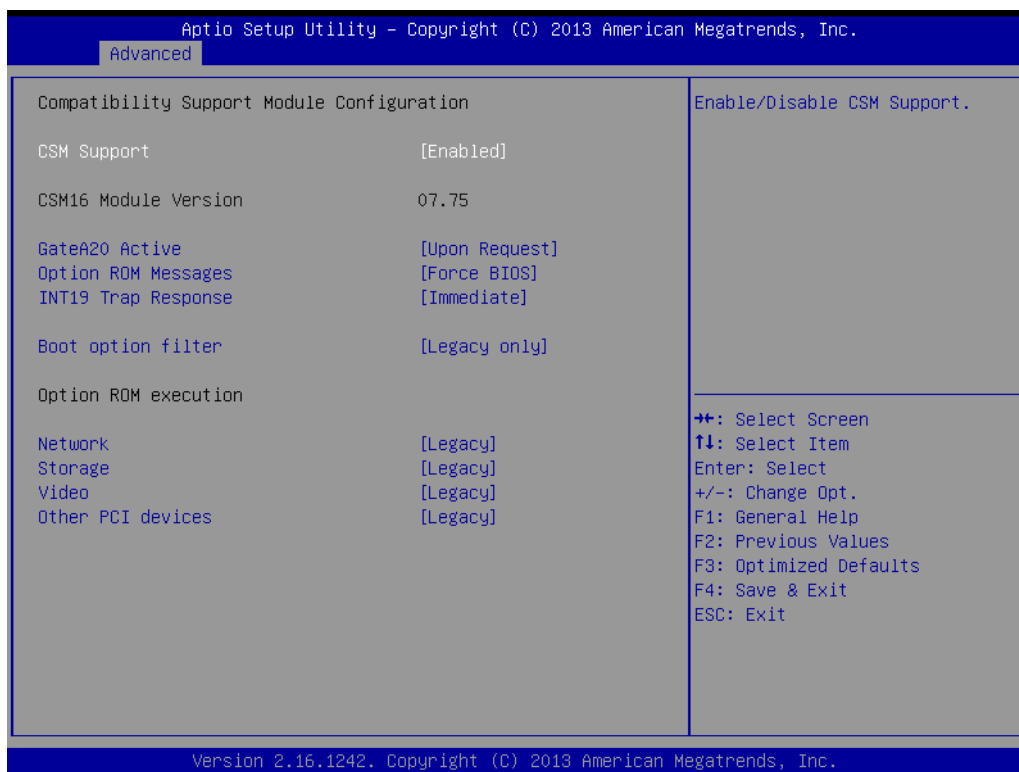

- **CSM Support**
- Enable/Disable CSM Support.
- **GateA20 Active**
- UPON REQUEST - GA20 can be disabled using BIOS services. We suggest you do not disable GA20 as this option is useful when any RT code is executed above 1MB.
- **Option ROM Messages**
Set display mode for Option ROM.
- **INT19 Trap Response**
BIOS reaction on INT19 trapping by Option ROM: IMMEDIATE - execute the trap right away; POSTPONED - execute the trap during legacy boot.
- **Boot option filter**
This option controls Legacy/UEFI ROMs priority.
- **Network**
Controls the execution of UEFI and Legacy PXE OpROM.
- **Storage**
Controls the execution of UEFI and Legacy Storage OpROM.
- **Video**
Controls the execution of UEFI and Legacy Video OpROM.
- **Other PCI devices**
Determines OpROM execution policy for devices other than Network, Storage, or Video.

3.4.10 Trusted Computing

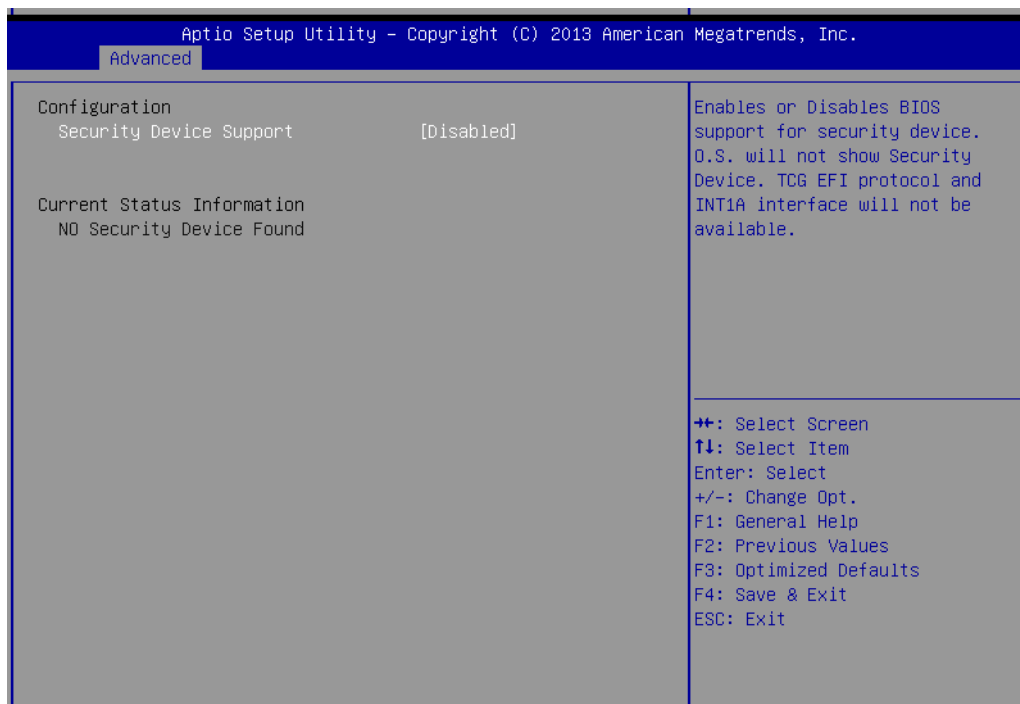

- Trusted Computing**
 Enables or Disables BIOS support for security devices. The OS will not show the Security Device. TCG EFI protocol and INT1A interface will not be available.

3.4.11 USB Configuration



- **Legacy USB Support**
Enables Legacy USB support. AUTO option disables legacy support if no USB devices are connected. DISABLE option will keep USB devices available only for EFI applications.
- **XHCI Hand-off**
This is a workaround for Oses without XHCI hand-off support. The XHCI ownership change should be claimed by XHCI driver.
- **EHCI Hand-Off**
This is a workaround for Oses without EHCI hand-off support. The EHCI ownership change should claim by EHCI driver.
- **USB Mass Storage Driver Support**
Enable/Disable USB Mass Storage Driver Support.
- **USB transfer time-out**
Time-out value for control, Bulk, and interrupt transfers.
- **Device reset time-out**
USB mass storage device start unit command time-out.
- **Device power-up delay**
Maximum time the device will take before it properly reports itself to the Host Controller. 'Auto' uses default value: for a Root port it is 100 ms, for a Hub port the delay is taken from Hub descriptor.

3.5 Security Configuration



- **TXE**
- **TXE HMRFPD Disable**
- **TXE Firmware Update**
- **TXE EOP Message**
Send EOP Message Before Enter OS

- **TXE Unconfiguration Perform**
Revert TXE settings to factory defaults

3.5.1 Chipset Configuration

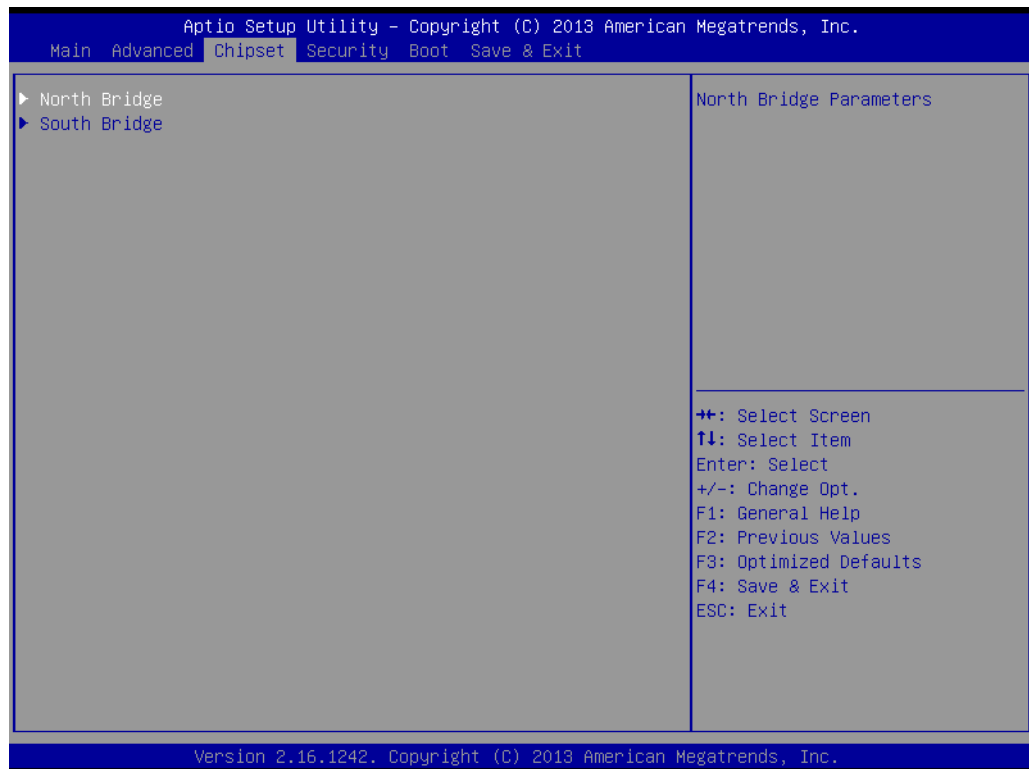

- **North Bridge**
Details for North Bridge items.
- **South Bridge**
Details for South Bridge items.

3.5.2 North Bridge

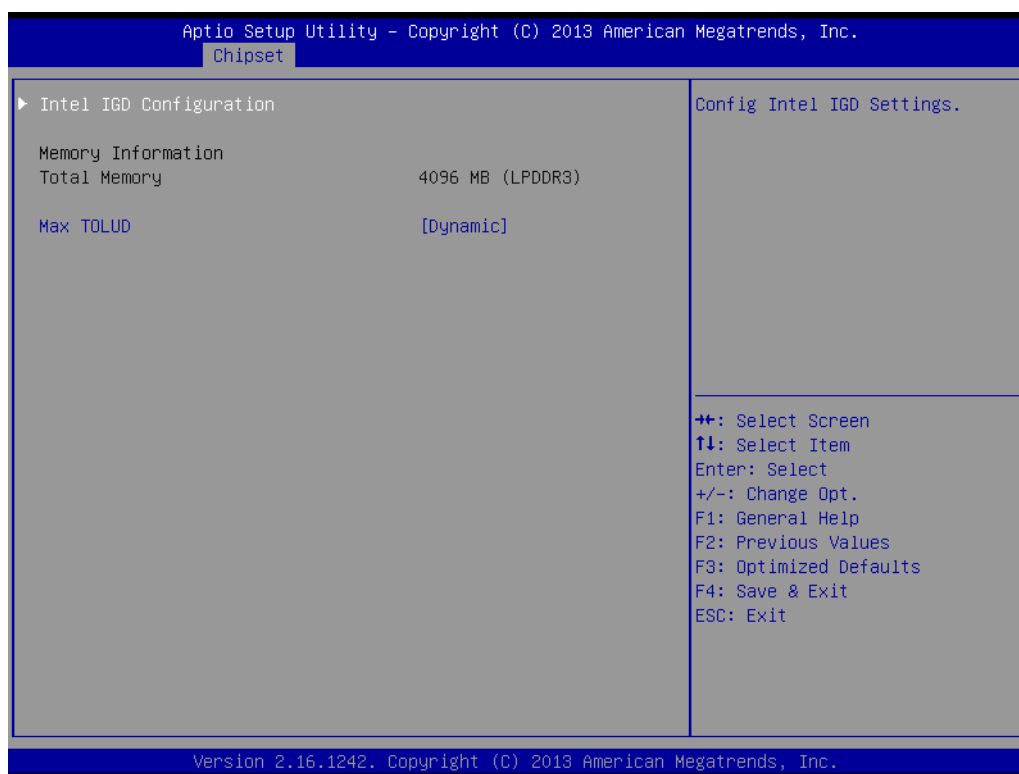

- **Intel IGD Configuration**
Config Intel IGD Settings.
- **Max TOLUD**
Maximum Value of TOLUD.

3.5.3 Intel IGD Configuration

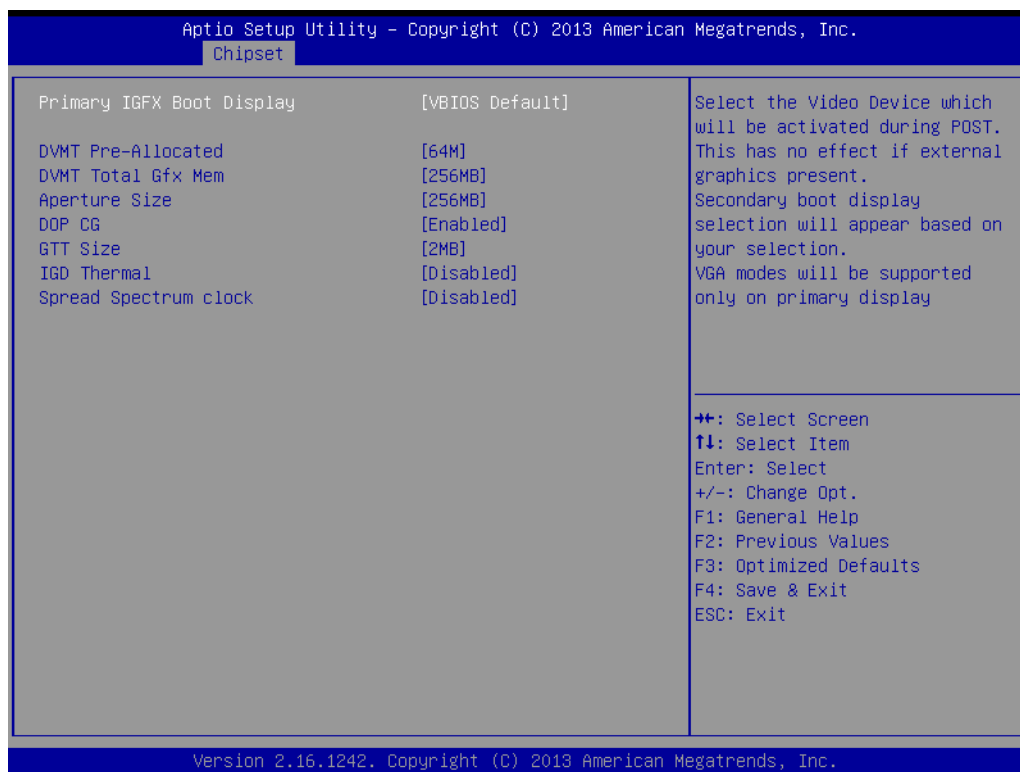

- **Primary IGFX Boot Display**
Select the Video Device which will be activated during POST. This has no effect if an external graphics present. Secondary boot display selection will appear based on your selection. VGA modes will be supported only on primary display.
- **DVMT Pre-Allocated**
Select DVMT 5.0 Pre-Allocated (Fixed) Graphics Memory size used by the Internal Graphics Device.
- **DVMT Total Gfx Mem**
Select DVMT 5.0 Total Graphic Memory size used by the Internal Graphics Device.
- **Aperture Size**
Select the Aperture Size.
- **DOP CG**
Enable/Disable DOP clock gating.
- **GTT Size**
Select the GTT Size.
- **IGD Thermal**
Enable/Disable IGD Thermal.
- **Spread Spectrum clock**
Enable/Disable Spread Spectrum clock.

3.5.4 South Bridge

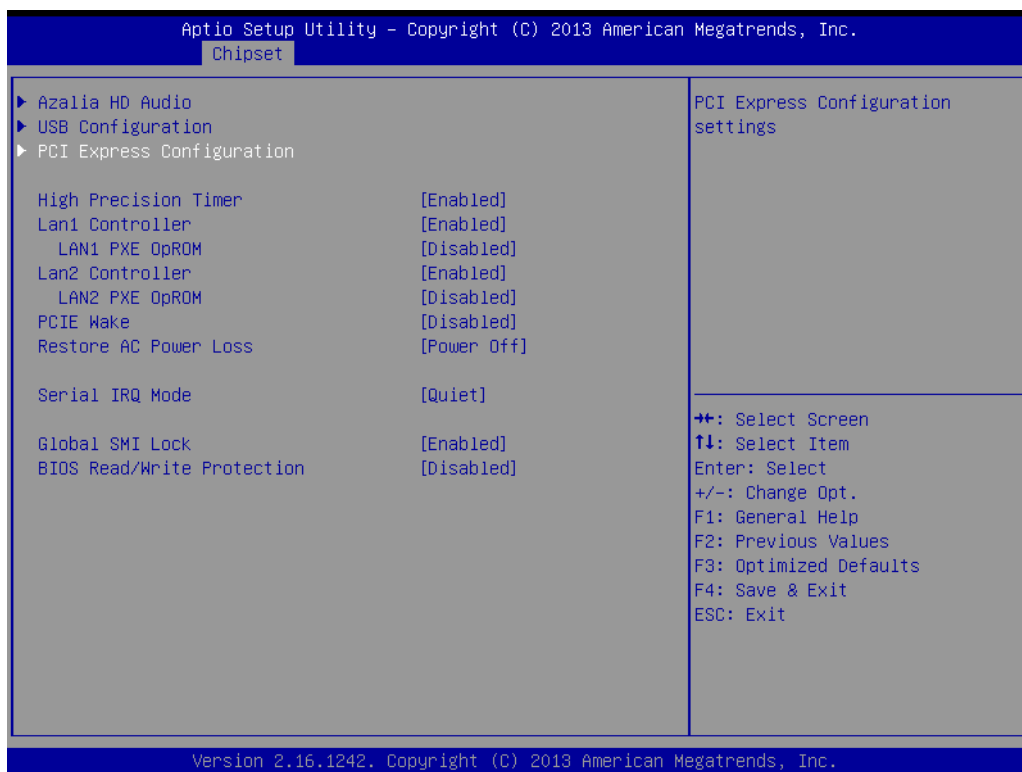

- **Azalia HD Audio**
Azalia HD Audio Options.
- **USB Configuration**
USB Configuration Settings.
- **PCI Express Configuration**
PCI Express Configuration settings.
- **High Precision Timer**
Enables or disables the high precision timer.
- **LAN1 Controller**
Enable or Disable the LAN1.
- **LAN2 Controller**
Enable or Disable the LAN2.
- **PCIE Wake**
Enable or Disable PCIE to wake the system from S5.
- **Restore AC Power Loss**
Select AC power state when power is re-applied after a power failure.
- **Serial IRQ Mode**
Configure Serial IRQ Mode.
- **Global SMI Lock**
Enable or Disable SMI lock.
- **BIOS Read/Write Protection**
Enable or Disable BIOS SPI region read/write protect.

3.5.5 Azalia HD Audio

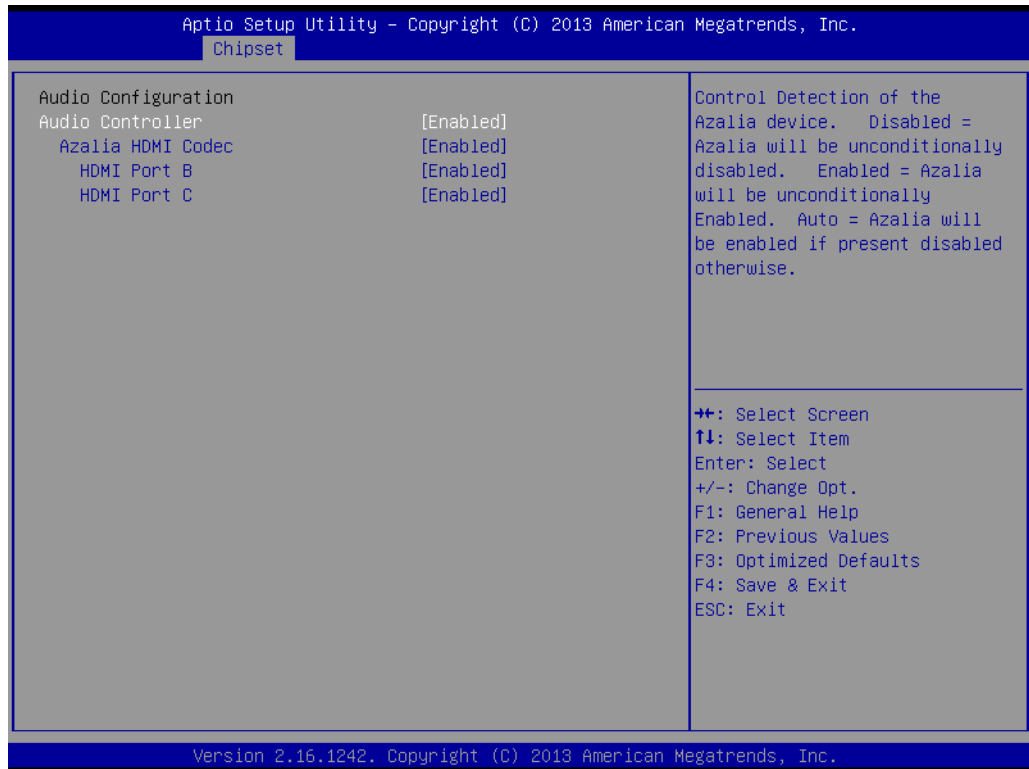

- **Audio Controller**
Control Detection of the Azalia device. Disabled = Azalia will be unconditionally disabled. Enabled = Azalia will be unconditionally Enabled. Auto = Azalia will be enabled if present disabled otherwise.
- **Azalia HDMI Codec**
Enable/Disable internal HDMI codec for Azalia.
- **HDMI Port B**
Enable/Disable HDMI Port B.
- **HDMI Port C**
Enable/Disable HDMI Port C.

3.5.6 USB Configuration

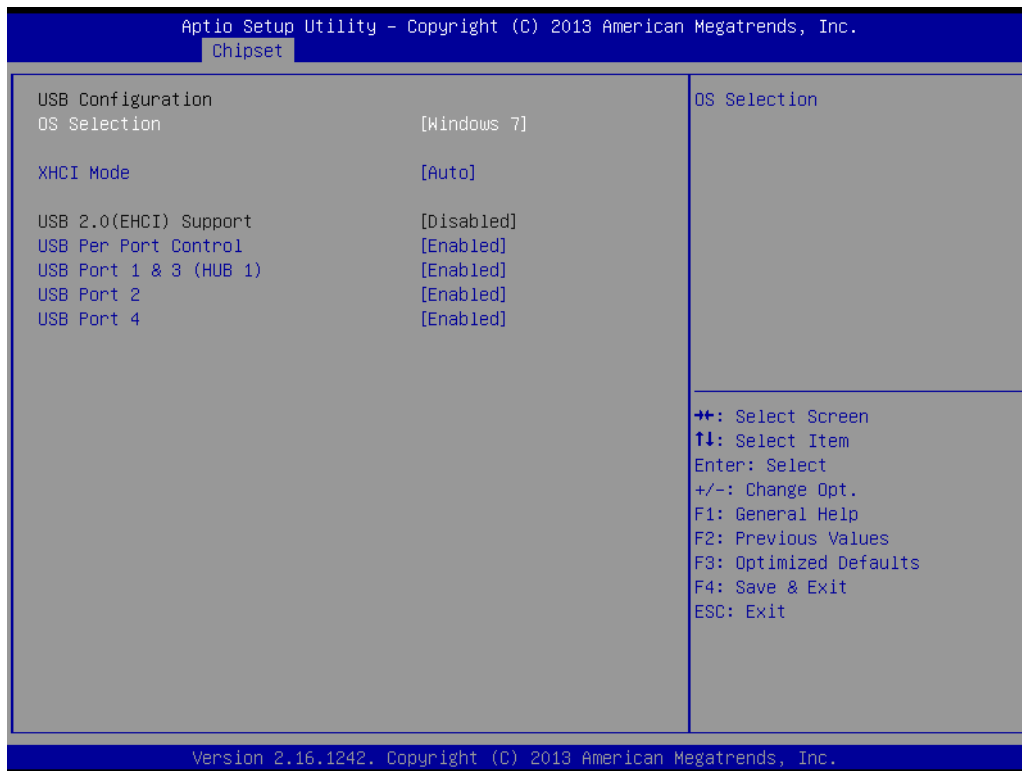

- **OS Selection**
OS Selection to choose Windows 8.X / Windows 7.
- **XHCI Mode**
Mode of operation of xHCI controller.
- **USB 2.0(EHCI) Support**
Control the USB EHCI (USB 2.0) functions. One EHCI controller must always be enabled.
- **USB Per Port Control**
Control each of the USB ports (1~4). Enable: Enable USB per port; Disable: Use USB port X settings.

3.5.7 PCI Express Configuration

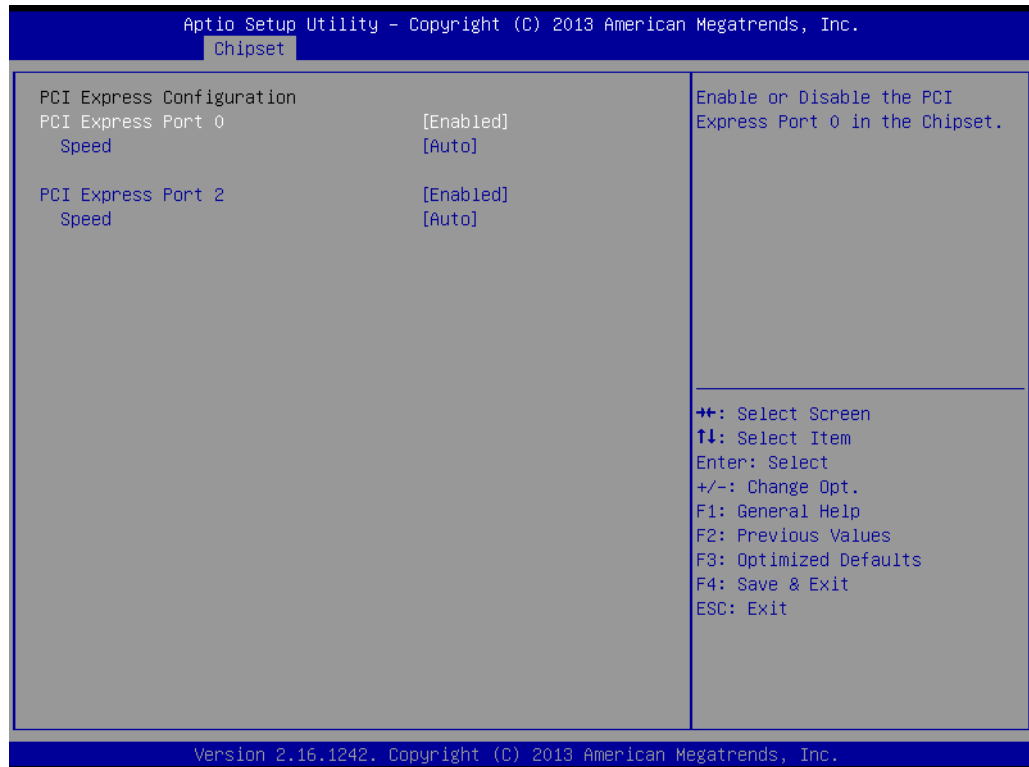

- **PCI Express Port0 / Port2**
Enable or Disable the PCI Express Port0 / Port 2 in the Chipset.
- **Speed**
Configure PCIe Port Speed.

3.6 Boot Settings



- **Setup Prompt Timeout**
Number of seconds that the firmware will wait before initiating the original default boot selection. A value of 0 indicates that the default boot selection is to be initiated immediately on boot. A value of 65535(0xFFFF) indicates that firmware will wait for user input before booting. This means the default boot selection is not automatically started by the firmware.
- **Bootup NumLock State**
Select the keyboard NumLock state.
- **Quiet Boot**
Enables or disables Quiet Boot option.
- **Boot Option #1**
Sets the system boot order.

3.7 Security Setup

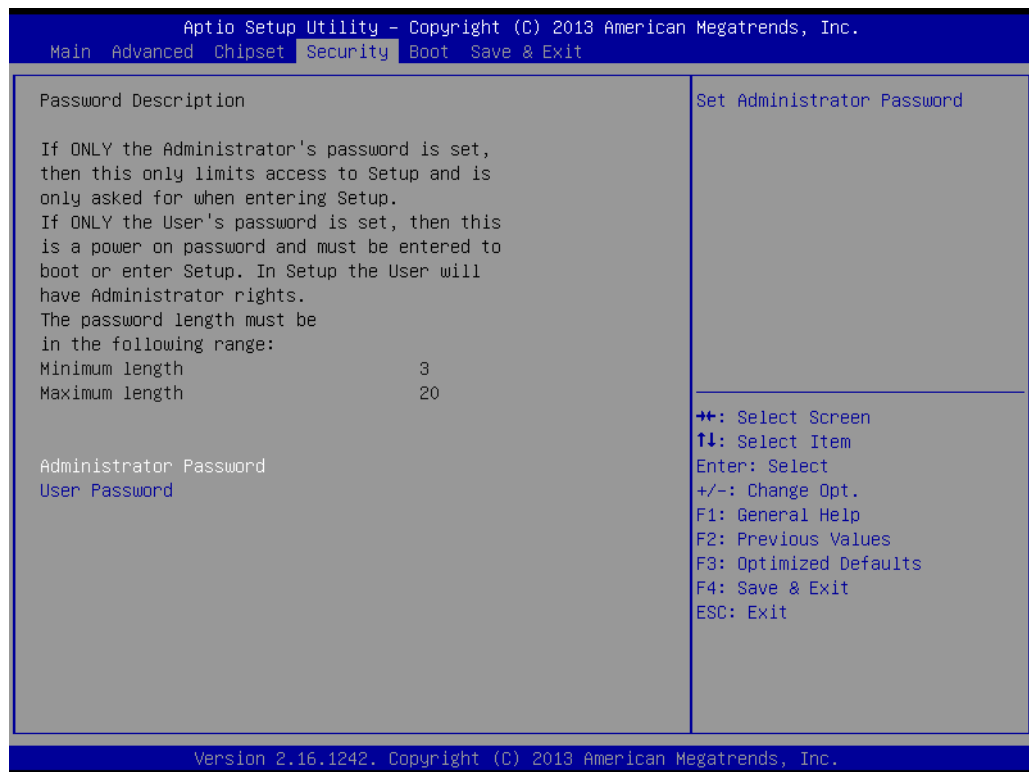

Select Security Setup from the ARK-2121 Setup main BIOS setup menu. All Security Setup options, such as password protection is described in this section. To access the sub menu for the following items, select the item and press <Enter>:

- **Change Administrator / User Password**
Select this option and press <ENTER> to access the sub menu, and then type in the password.

3.8 Save & Exit



- **Save Changes and Exit**
This item allows you to exit system setup after saving the changes.
- **Discard Changes and Exit**
This item allows you to exit system setup without saving any changes.
- **Save Changes and Reset**
This item allows you to reset the system after saving the changes.
- **Discard Changes and Reset**
This item allows you to rest system setup without saving any changes.
- **Save Changes**
This item allows you to save changes done so far to any of the options.
- **Discard Changes**
This item allows you to discard changes done so far to any of the options.
- **Restore Defaults**
This item allows you to restore/load default values for all the options.
- **Save as User Defaults**
This item allows you to save the changes done so far as user defaults.
- **Restore User Defaults**
This item allows you to restore the user defaults to all the options.
- **Boot Override**
Boot device select can override your boot priority.

Appendix **A**

Watchdog Timer
Sample Code

A.1 EC Watchdog Timer Sample Code

```
EC_Command_Port = 0x29Ah
EC_Data_Port = 0x299h
Write EC HW ram = 0x89
Watch dog event flag = 0x57
Watchdog reset delay time = 0x5E
Reset event = 0x04
Start WDT function = 0x28
=====
.model small
.486p
.stack 256
.data
.code
org 100h
.STARTUp

mov dx, EC_Command_Port
mov al,89h      ; Write EC HW ram.
out dx,al

mov dx, EC_Command_Port
mov al, 5Fh     ; Watchdog reset delay time low byte (5Eh is high byte) index.
out dx,al

mov dx, EC_Data_Port
mov al, 30h     ;Set 3 seconds delay time.
out dx,al

mov dx, EC_Command_Port
mov al,89h     ; Write EC HW ram.
out dx,al

mov dx, EC_Command_Port
mov al, 57h    ; Watch dog event flag.
out dx,al

mov dx, EC_Data_Port
mov al, 04h    ; Reset event.
out dx,al

mov dx, EC_Command_Port
mov al,28h    ; start WDT function.
out dx,al

.exit
END
```

ADVANTECH

Enabling an Intelligent Planet

www.advantech.com

Please verify specifications before quoting. This guide is intended for reference purposes only.

All product specifications are subject to change without notice.

No part of this publication may be reproduced in any form or by any means, electronic, photocopying, recording or otherwise, without prior written permission from the publisher.

All brand and product names are trademarks or registered trademarks of their respective companies.

© Advantech Co., Ltd. 2020