

L32

1U Liquid Cooler

PRODUCT SPECIFICATIONS

Model Number: L32

- Recommend for AMD® CPU as following
 - AMD® Genoa® Processor Family, Socket SP5;
- Liquid Cooler for 1U Server & Up

Overall Specification

- Cold Plate Module with Copper base
- Space-saving lightweight Radiator
- 40 mm Cooling fans with 4-pin PWM connector
- Stand-alone Water Pump with Powerful Flow Rate 1.7 Litter Per Minute
- EPDM Tube Assembled
- Mounting Accessories are included
- Shin-Etsu 7762 or Equivalent Thermal Compound Pre-Printed on Base
- Support up to 500 Watts@40°C ambient CPU Power Heat Dissipation.

Cooling Fan Specification

Model Number	DF124028BH-PWMG
Dimension	40 x 40 x 28 mm
Bearing	Double Ball
Rated Voltage	12V
Rated Speed	At Duty Cycle 0~20%: 7000±10% RPM At Duty Cycle 50%: 11000±10% RPM At Duty Cycle 100%: 15000±10% RPM
Input Power	At Duty Cycle 0~20%: 2.04 W At Duty Cycle 50%: 4.68 W At Duty Cycle 100%: 10.80 W
Maximum Airflow	At Duty Cycle 0~20%: 12.56 CFM At Duty Cycle 50%: 19.73 CFM At Duty Cycle 100%: 26.91 CFM
Rated Static Pressure	At Duty Cycle 0~20%: 7.80 mm-H2O At Duty Cycle 50%: 19.25 mm-H2O At Duty Cycle 100%: 35.80 mm-H2O
Acoustical Noise	At Duty Cycle 0~20%: 42.26 dBA At Duty Cycle 50%: 52.07 dBA At Duty Cycle 100%: 58.81 dBA
Lead Wire Pin Out	Pin#1- Black(-) Pin#2- Yellow(+) Pin#3- Green(Tachometer/ Signal Output) Pin#4- Blue (PWM)

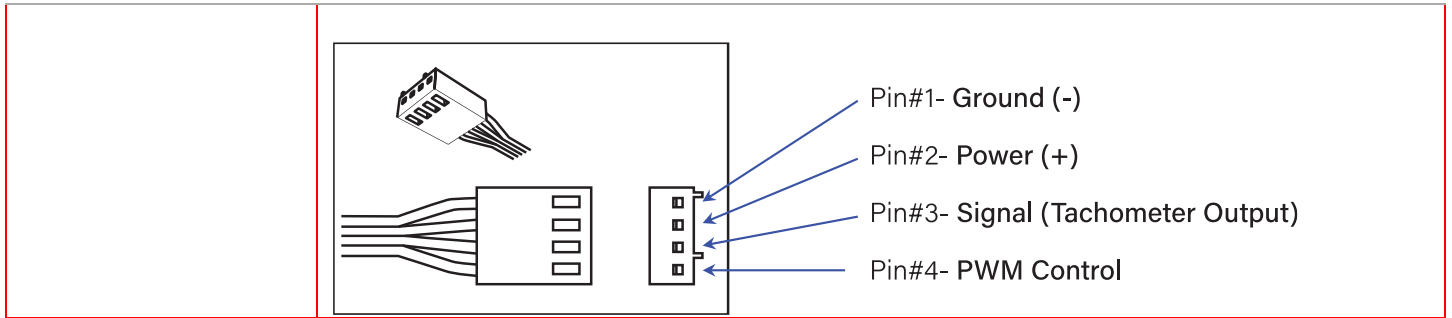

Performance Chart: Liquid Cooler L32 Thermal Resistance Liquid Cooler L32 Thermal Performance vs. Airflow

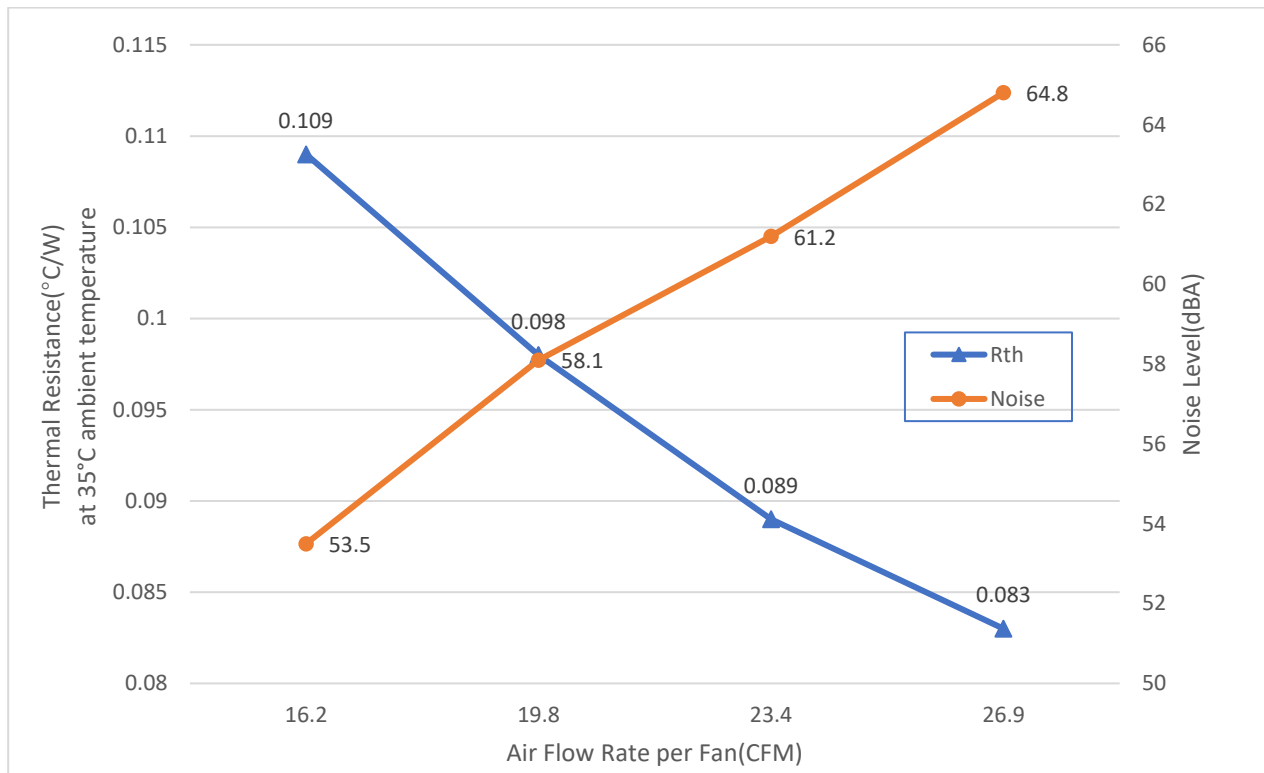

Liquid Cooler L32 Thermal Performance vs. Fan Speed

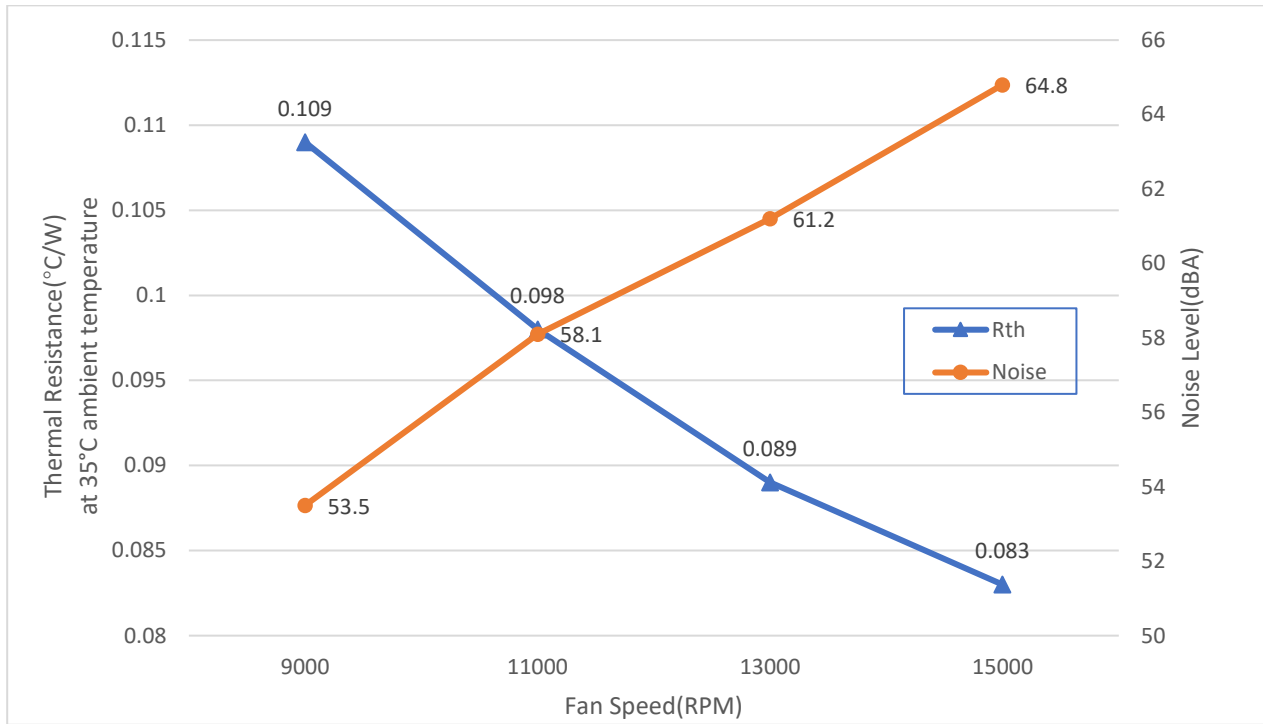

CONFIDENTIAL DOCUMENT

THIS DRAWING CONTAINS INFORMATION PROPRIETARY TO DYNATRON CORPORATION AND DYNAMEN INDUSTRIAL CO., LTD. ANY REPRODUCTION, DISCLOSURE, OR USE OF THIS DRAWING IS EXPRESSLY PROHIBITED EXCEPT AS DYNATRON CORPORATION AND DYNAMEN INDUSTRIAL CO., LTD. MAY OTHERWISE AGREE TO IN WRITING.

REV#	DESCRIPTION	CHECKER	DATE
0.0	INITIAL RELEASE	Joy	04/05/22

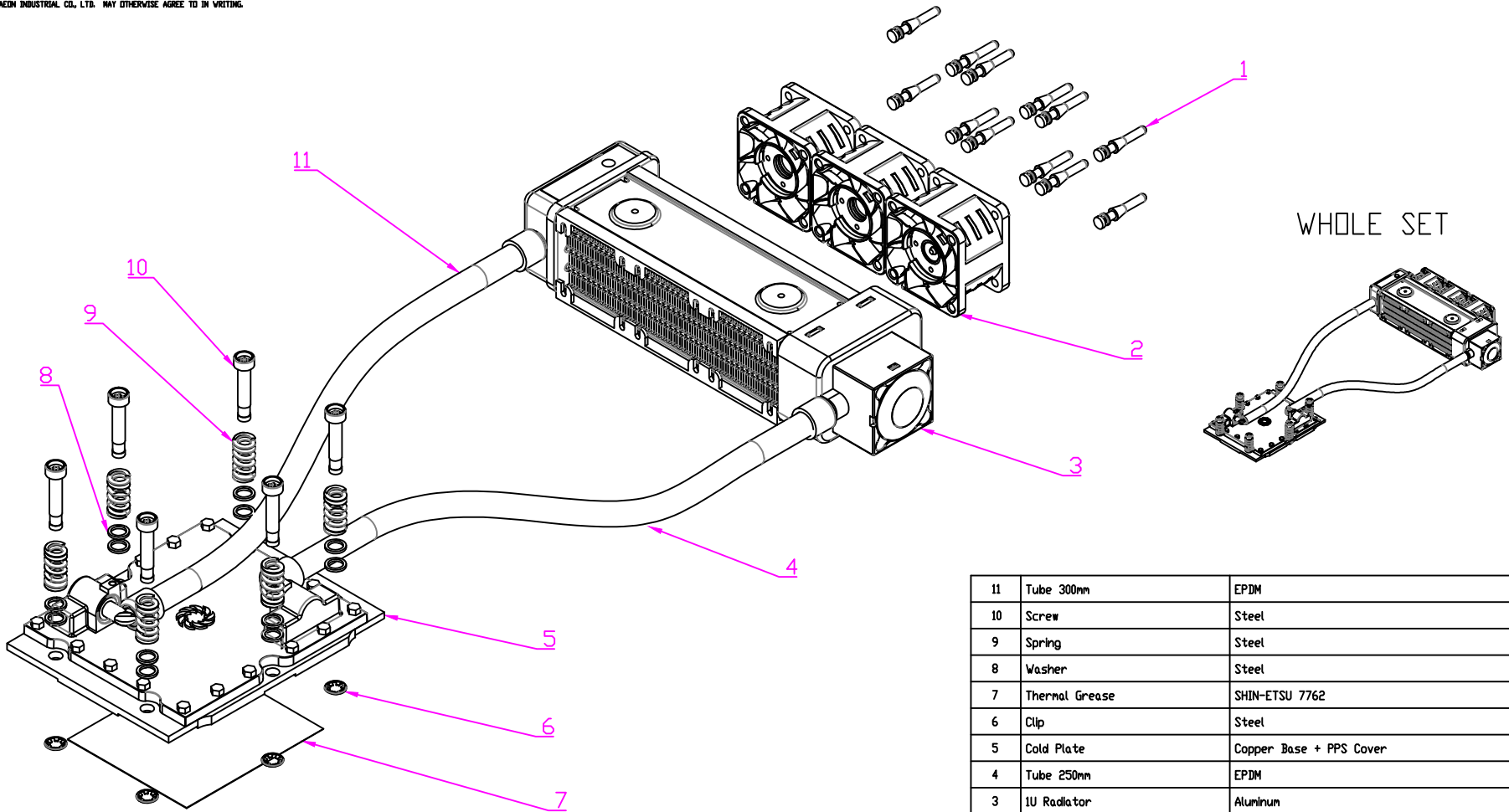

11	Tube 300mm	EPDM	1
10	Screw	Steel	6
9	Spring	Steel	6
8	Washer	Steel	12
7	Thermal Grease	SHIN-ETSU 7762	1
6	Clip	Steel	6
5	Cold Plate	Copper Base + PPS Cover	1
4	Tube 250mm	EPDM	1
3	1U Radiator	Aluminum	1
2	Fan DF124028BH-PWNG(15000RPM)	PBT	3
1	Grommet	Rubber	12
ITEM #	DESCRIPTION	MATERIAL	QTY.

	DATE	NAME	 DYNATRON CORPORATION
DRAWN	04/05/2022	ENGR	
CHECKED	04/05/2022	Joy	
ENG. APPR.			
MFG. APPR.			
TITLE: 1U Liquid Cooler L32 BOM & Exploded Assembly Drawing			DWG. No: DYN-EP-L32
COMMENTS:			

1 2 3 4 5 6 7

REV#	DESCRIPTION	CHECKER	DATE
0.0	INITIAL RELEASE	JoyZ	04/05/2022

A

A

B

B

C

C

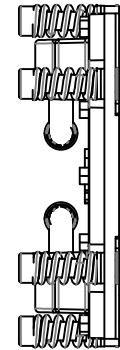
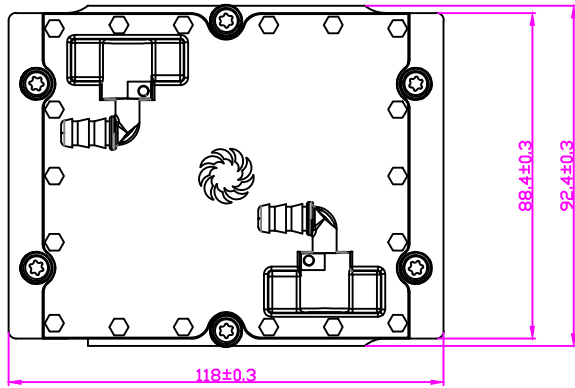

D

D

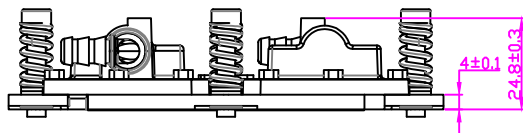

E

E

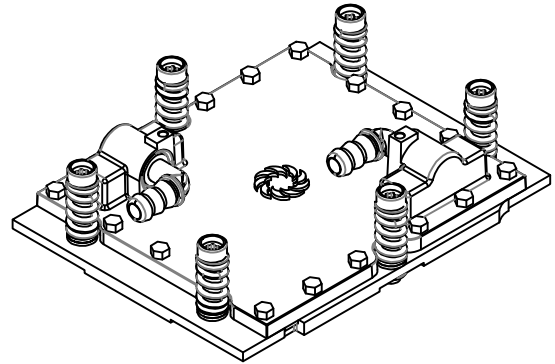
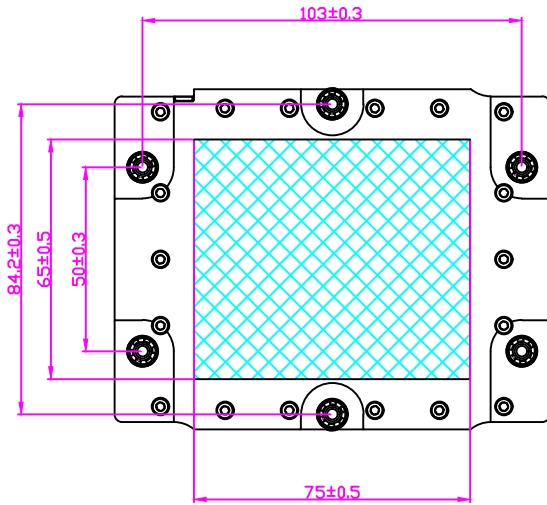

F

F

G

G

	NAME	DATE
DRAWN BY	ENGR	04/05/2022
CHECKED BY	JoyZ	04/05/2022
ENG. APPROVED		
MFG. APPROVED	-	-



DYNATRON CORPORATION

TITLE:

L32 Cold Plate
Overall Dimension Drawing

H

H

CONFIDENTIAL DOCUMENT
THIS DRAWING CONTAINS INFORMATION PROPRIETARY TO DYNATRON CORPORATION AND DYNAEON INDUSTRIAL CO., LTD. ANY REPRODUCTION, DISCLOSURE, OR USE OF THIS DRAWING IS EXPRESSLY PROHIBITED EXCEPT AS DYNATRON CORPORATION AND DYNAEON INDUSTRIAL CO., LTD. MAY OTHERWISE AGREE TO IN WRITING.

VIEW		DWG. No:	REV.
UNITS	MM	DYN-BD-L32 CP	0.0

1 2 3 4 5 6 7

1 2 3 4 5 6 7

REV#	DESCRIPTION	CHECKER	DATE
0.0	INITIAL RELEASE	LANG	11/22/2019

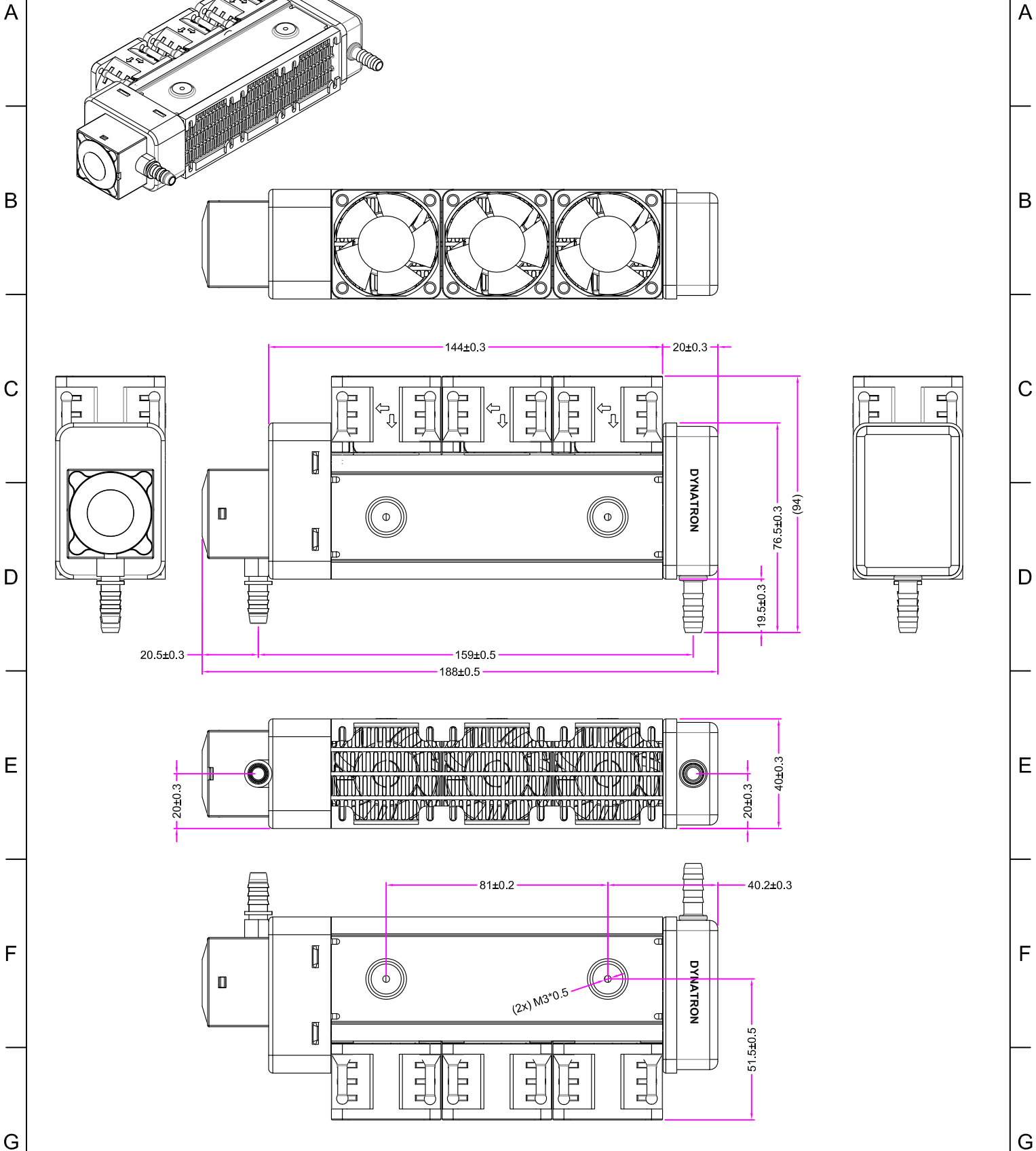

	NAME	DATE
DRAWN BY	ENGR	11/22/19
CHECKED BY	LANG	11/22/19
ENG. APPROVED		
MFG. APPROVED	-	-



DYNATRON CORPORATION

TOP MOTOR

TITLE: **1U Server Liquid Cooler Condenser Overall Dimension Drawing**

CONFIDENTIAL DOCUMENT
 THIS DRAWING CONTAINS INFORMATION PROPRIETARY TO DYNATRON CORPORATION AND DYNAEON INDUSTRIAL CO., LTD. ANY REPRODUCTION, DISCLOSURE, OR USE OF THIS DRAWING IS EXPRESSLY PROHIBITED EXCEPT AS DYNATRON CORPORATION AND DYNAEON INDUSTRIAL CO., LTD. MAY OTHERWISE AGREE TO IN WRITING.

VIEW	
UNITS	MM

DWG. No:

REV. **0.0**

1 2 3 4 5 6 7

TOP MOTOR TECHNOLOGY (HUIZHOU) CO, LTD
Specification for Approval

Customer:		
Model Number:	DF124028BH-PWMG	
Part Number: (Manufacturer)	DF124028BH	
Issued Date:	1/21/2015	
Customer Approval		
Approval:	Check:	
Corporate Headquarters Dynatron Corporation 33200 Western Avenue Union City, CA 94587 U.S.A. Tel: 510-498-8888 Fax: 510-498-8488	Manufactory TOP MOTOR TECHNOLOGY(HUI ZHOU)CO,LTD Baishi Village,QiuchangTown, Huiyang Dist,HuizhouCity,Guangdong Province,P.R.China Tel: 86-752-353-5591 (Rep.) Fax: 86-752-353-5592	
<i>Taipei Office (Taiwan, R.O.C.)</i> 8F, No. 35,Lane:221, Gang Cian Road, Taipei, Taiwan, R.O.C. Tel: 886-2-2799-5799(Rep.) Fax: 886-2-2799-9577		
Approval:	Check:	Initiator:
Simon_Wang	-	Jandy Chan

TOP MOTOR TECHNOLOGY (HUIZHOU) CO, LTD

CONTENTS		
		Page
1.	SCOPE	3
2.	ELECTRICAL CHARACTERISTICS	3
3.	MECHANICAL CHARACTERISTICS	4
4.	ENVIRONMENTAL	4
5.	PROTECTION	5
6.	ATTACHMENTS	5
	6.1. Product Dimension	6
	6.2. Frequency Generator Output	7
	6.3. TUV Certificate	8
	6.4. UL Certificate	9-12
	6.5. Electrical specifications for PWM production	13-14

TOP MOTOR TECHNOLOGY (HUIZHOU) CO, LTD

1. SCOPE

This specification defines the electrical and mechanical characteristics of the AC / DC Brush Less (Liquid State / 2-Balls Bearing) axial flow fan, which is carefully designed and manufactured for your special needs by Dynatron Corporation.

2. ELECTRICAL CHARACTERISTICS

Items		Description		
1.	Rated Voltage	DC 12 V		
2.	Operating Voltage	10.8V~13.2V		
3.	PWM Frequency 25KHz	Duty Cycle D=20%	Duty Cycle D=50%	Duty Cycle D=100%
4.	Start Voltage	8V		
5.	Air Flow – At rated voltage zero static pressure (minimal value)	0.356m ³ / min (12.557CFM)	0.559m ³ / min (19.733CFM)	0.762m ³ / min (26.908CFM)
6.	Static Pressure – At rated voltage At zero air flow	7.796mm -H ₂ O (0.307inch-H ₂ O)	19.252mm -H ₂ O (0.758inch-H ₂ O)	35.80mm-H ₂ O (1.409inch-H ₂ O)
7.	Input Current (Max.)	0.17A	0.39A	0.90A
8.	Speed	7000RPM±10%	11000RPM±10%	15000RPM±10%
9.	Acoustical Noise	42.26dBA	52.07dBA	58.81dBA
10.	Input Power	2.04W	4.68W	10.80W
11.	Insulation Resistance – Between Frame and Terminal	10 M ohm at DC 500 V		
12.	Dielectric Strength – Between Frame and Terminal	5 MA (Max.) @ AC 500 V 60 Hz 1 min.		
13.	Life – Continuous operating under normal temperature (40 °C or 104 °F)	70,000 hours		
14.	Rotation	Anticlockwise Air Discharged		
15.	Lead Wires	UL 1061,AWG 28 or Equivalent “-”: Black; “+”: Yellow;“s”: Green; “PWM”: Blue.		

TOP MOTOR TECHNOLOGY (HUIZHOU) CO, LTD

3. MECHANICAL CHARACTERISTICS

Items		Description
1.	Dimension	Display as Drawing
2.	Frame	PBT UL94V-0 (Black GP)
3.	Impeller	PBT UL94V-0 (Black GP)
4.	Bearing System	Two Ball Bearing
5.	Weight	38±5grams

4. ENVIRONMENTAL

Items		Description
1.	Operating Temperature	- 10 °C ~ + 65 °C (65 %RH)
2.	Storage Temperature	- 30 °C ~ + 70 °C (65 %RH)
3.	Vibration Test	Displacement Amplitude: 0.75mm(Equivalent 10G) Frequency Range: 10Hz<->55Hz/30SEC. Lineear Scanning 120 Cycle Endurance Timer Per Axis: 30Min. Orientation:X,Y,Z.
4.	Drop Test	Motor withstands one free body drop from 30 cm in high onto 10 mm thickness of wooden board for each of the three faces in minimum packing condition.
5.	Acoustic Noise	42.26/52.07/58.81dBA – Curve (42.76/52.57/59.31Max) Measuring Condition – Under rated voltage in semi-anechoic chamber equipment sound level meter. (Figure A.)

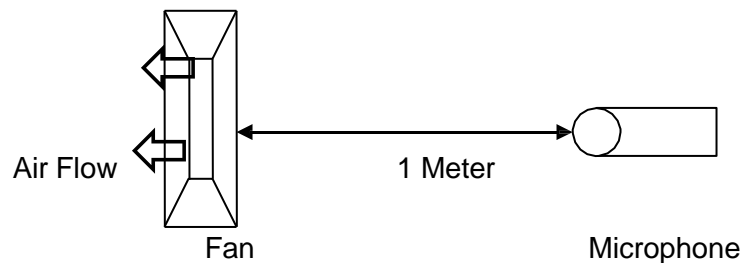

Figure A – Noise Level is measure at rated voltage in anechoic chamber in free air as above.

TOP MOTOR TECHNOLOGY (HUIZHOU) CO, LTD

5. PROTECTION

Items		Description
1.	Polarity Protection	For polarity error connection to power, the circuit withstands reversed connection between positive and negative leads.

6. ATTACHMENTS

- 6.1. Product Dimension
- 6.2. Frequency Generator Output
- 6.3. TUV Certificate
- 6.4. UL Certificate
- 6.5. Electrical specifications for PWM production

TOP MOTOR TECHNOLOGY (HUIZHOU) CO, LTD

6.1. Product Dimension

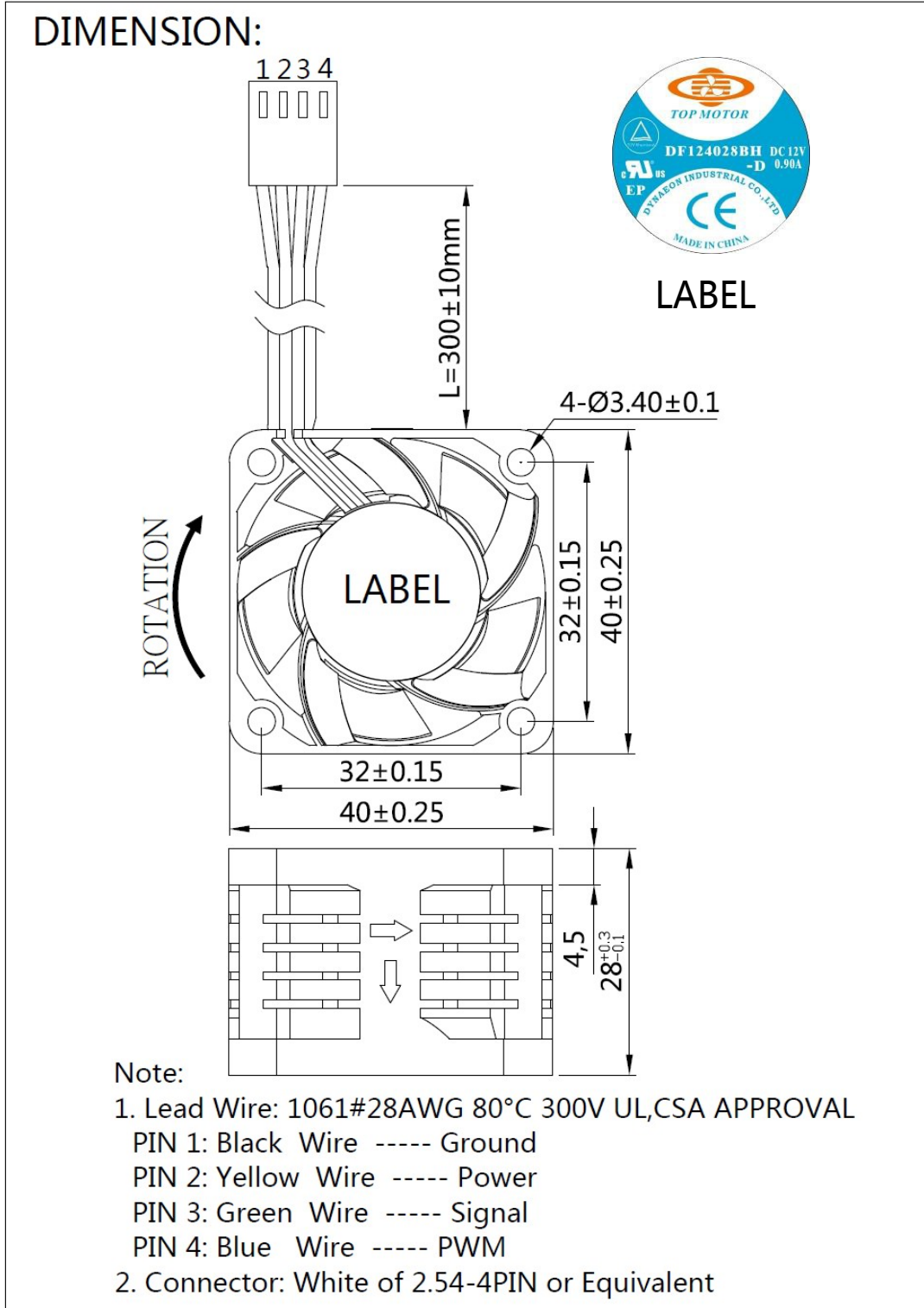

TOP MOTOR TECHNOLOGY (HUIZHOU) CO, LTD

6.2. Frequency Generator Output

FREQUENCY GENERATOR O/P:

Frequency generator function is activated by an internal IC for customer's application.
Electrical schematic:

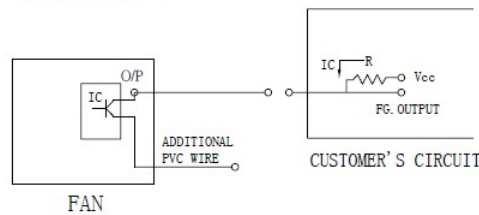

CUSTOMER'S CIRCUIT

Vcc = From +5 To +28 VDC (Generally using +12 or +24 VDC)
Ic = 5 mA max.
R = V/I (Output "R" value calculation)

● SUPPLY A WAVEFORM:

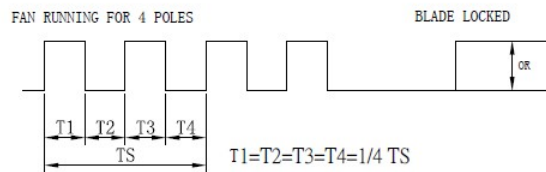

N=R.P.M. (Rotation speed will be different for various models
L/M/H/HH/VH/SH)

TS=60/N (Sec)

* Voltage level after blade locked

● OUTPUT LEVEL:

High = Vcc 10%
Low = 0~0.5V
Ic = 5 mA max.

● APPLICATION:

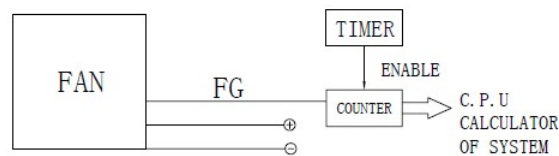





● FUNCTIONS:

- . By means of waveform & customer's design, schematic can reach alarm function, either in the form of buzzing or LED flashing.
Adjust rotation speed.
- . When power supply output voltage level decreases, it will result in the lowering of fan rotation speed. The irregular situation will be controlled by using FG. O/P through P/S circuit to increase the output voltage and result in a stable rotation speed.

TOP MOTOR TECHNOLOGY (HUIZHOU) CO, LTD

6.3. TUV Certificate

Zertifikat		Certificate			
Zertifikat Nr. <i>Certificate No.</i> R 50064443		Blatt <i>Page</i> 0007			
Ihr Zeichen <i>Client Reference</i> 12046290/LC Tech		Unser Zeichen <i>Our Reference</i> ZTW1-CCO- 10013649 006		Ausstellungsdatum <i>Date of Issue</i> 07.05.2007 <i>(day/month/yr)</i>	
Genehmigungsinhaber <i>License Holder</i> Dynaeon Industrial Co., Ltd. 8F, No. 35, 37, Lane 221 Gang Cian Rd. Neihu, Taipei 114 Taiwan, R.O.C.			Fertigungsstätte <i>Manufacturing Plant</i> Dynaeon Ind. Co., Ltd. Ta-Li Management Zone Ching-Hsi, Dongguan P.R. China		
Prüfzeichen <i>Test Mark</i>		Geprüft nach <i>Tested acc. to</i> EN 60950-1:2001+A11			
					
Zertifiziertes Produkt (Geräteidentifikation) <i>Certified Product (Product Identification)</i>			Lizenzentgelte - Einheit <i>License Fee - Unit</i>		
Ventilator (DC Fan)					
wie Blatt (as page) 01					
Ergänzung (Addition)					
Bezeichnung : DF(X1) (X2) (X3) (X4) (X5) ZZZZZ- (X6) (Type Designation)					
(X1) steht für (stands for): 05, 12, 24					
(X2) steht für (stands for): 12, 14, 15, 25, 40, 50, 60, 70, 77, 80, 92			1		
(X3) steht für (stands for): 10, 15, 20, 25, 28			1		
(X4) steht für (stands for): S, B, P, Q					
(X5) steht für (stands for): U, H, M, L, E					
(X6) steht für (stands for): A, B, C, D			1		
Z steht für (stands for): A-Z, 0-9 oder (or) freibleibend (blank)					
Nennspannung : DC 5V ((X1)= 05); DC 12V ((X1)= 12); (Rated Voltage) DC 24V ((X1)= 24)					
Nennstrom : siehe Anlage (Rated Current) (see appendix)					
ANLAGE (Appendix): 1					
Dem Zertifikat liegt unsere Prüf- und Zertifizierungsordnung zugrunde. Das Produkt entspricht den o.g. Anforderungen, die Herstellung wird überwacht. This certificate is based on our Testing and Certification Regulation. The product fulfills above mentioned requirements, the production is subject to surveillance.			Zertifizierungsstelle		
TÜV Rheinland Product Safety GmbH, Am Grauen Stein, D-51105 Köln Tel.: (+49/221)8 06 - 13 71 e-mail: cert-valstty@de.tuv.com Fax: (+49/221)8 06 - 39 35 http://www.tuv.com/safety			 Dipl.-Ing. F. Stückel		

TOP MOTOR TECHNOLOGY (HUIZHOU) CO, LTD

6.4. UL Certificate



ONLINE CERTIFICATIONS DIRECTORY

GPWV2.E157868 Fans, Electric - Component

[Page Bottom](#)

Fans, Electric - Component

[See General Information for Fans, Electric - Component](#)

DYNAEON INDUSTRIAL CO LTD
8TH FL 35 LANE 221 GANGCIAN RD
NEIHU DIST
TAIPEI, 114 TAIWAN

E157868

DC fans, Models D(F)1206(Z)(Y1)(X1), D(F)1207(Z)(Y1)(X1), where (F) may be F or C, (Z) may be SH, BH, BA, SM, BM, BB, SL, BL, BC, SD, BE, BF, SG, BI, BJ, SK, BN, BO, SP, BQ, BR, SS, BT, BU, SV, BW, BX, SY, BY or BZ, (Y1) may be "-", 0 through 9 or A through Z, (X1) may be 0 through 9 or A through Z.

Models DF248015(S)(X)(Y)(Z)(W), DF488015(S)(X)(Y)(Z)(W), where (S) may be S, B or P, (X) may be U, H, M or L, (Y) and (Z) may be any alphanumeric character, blank, "-" or any symbol, (W) may be seven any alphanumeric character, blank, "-" or any symbol.

Models DF121225(A)(B)(C), DF121225(A)E(C), DF241225(A)(B)(C), DF128015(A)U(C), DF128015(A)(B)(C), DF128025(A)U(C), DF128025(A)(B)(C), DF128025(A)E(C), DF248025(A)U(C), DF248025(A)(B)(C), DF129225(A)(B)(C), DF129225(A)E(C), DF249225(A)U(C), DF249225(A)(B)(C), DF126010(A)(B)(C), DF246025(A)U(C), DF246025(A)(B)(C), DF126025(A)U(C), DF126025(A)(B)(C), DF126025(A)E(C), DB126015BU(C), DB126015B(B)(C), DF123010(A)(B)(C), DF053010(A)(B)(C), DF127015(A)U(C), DF127015(A)(B)(C), DF245010(A)(B)(C), where (A) may be S, B, P or Q, (B) may be H, M or L, (C) may be xxxxxxxx, where x may be A through Z, 0 through 9, "-" or blank.

Models DF122510(X)(Y2)(Z)-(M), DF124020(X)(Y2)(Z)-(M), DF244020(X)(Y1)(Z)-(M), DF126025(X)(Y3)(Z)-(M), DF246025(X)(Y3)(Z)-(M), DF121225(X)(Y1)(Z)-(M), DF124028(X)(Y3)(Z)-(M), where (X) may be S, B, P, Q, (Y1) may be H, M or L, (Y2) may be U, H, M or L, (Y3) may be U, H, M, L or E, (Z) is alphanumeric combination of five digits and/or alphabets, may be A through Z, 0 through 9 or blank, (M) may be A or B.

Models DF054010(X)(Y2)(Z1)(Z2)-A, DF054010(X)L(Z1)(Z2)-B, DF124010(X)(Y2)(Z1)(Z2)-A, DF124010(X)L(Z1)(Z2)-B, DF244010(X)(Y2)(Z1)(Z2)-A, DF125015(X)(Y1)(Z1)(Z2)-A, DF125020(X)(Y3)(Z1)(Z2)-A, DF126015(X)(Y1)(Z1)(Z2)-A, DF246015(X)M(Z1)(Z2)-A, DF246015(X)L(Z1)(Z2)-A, DF128020(X)(Y1)(Z1)(Z2)-A, DF128020(X)L(Z1)(Z2)-B, DB127015(X)(Y2)(Z)-A series, where (X) may be S, B, P, Q, (Y1) may be H, M or L, (Y2) may be U, H, M or L, (Y3) may be H, M, L or E, (Z1) may be blank or 3, (Z2) is alphanumeric combination of four digits and/or alphabets, may be A through Z, 0 through 9 or blank, (Z) is alphanumeric combination of five digits and/or alphabets, may be A through Z, 0 through 9 or blank.

Models DF125010(X)(Y)(Z)-A, DF126020(X)(Y)(Z)-A, DF246020(X)(Y)(Z)-A, DF121525(X)(Y1)(Z)-A, DF121525(X)(Y2)(Z)-B series, where (X) may be S, B, P or Q, (Y) may be H, M or L, (Y1) may be U, H, M or L, (Y2) may be L or E, (Z) is alphanumeric combination of five digits and/or alphabets, may be A through Z, 0 through 9 or blank.

Models DF128025(X)(a)(Y)-A, DF121225(X)(b)(Y)-C, DF121225(X)E(Y)-C, DF127720(X)(a)(Y)-A, DF121425(X)(c)(Y)-A, DF126010(X)E(Y)-A series, where (X) may be S, B, P, Q, (a) may be H, M, L or E, (b) may be M or L, (c) may be U, H, M, L or E, (Y) is alphanumeric combination of five digits and/or alphabets, may be A through Z, 0 through 9 or blank.

Models DF054010(X)(Y1)(Z1)(Z2)-C, DF124010(X)(Y2)(Z1)(Z2)-C, DF244010(X)(Y2)(Z1)(Z2)-C, DF124020BU(Z1)(Z2)-C, DF124020(X)(Y1)(Z1)(Z2)-C, DF124028BU(Z1)(Z2)-C, DF124028(X)(Y1)(Z1)(Z2)-C, DF126025BU(Z1)(Z2)-C, DF126025(X)(Y1)(Z1)(Z2)-C, DF127015BU(Z1)(Z2)-A, DF127015(X)(Y1)(Z1)(Z2)-A, DF128025BU(Z1)(Z2)-B, DF128025(X)(Y1)(Z1)(Z2)-B, DF129225BU(Z1)(Z2)-A, DF129225(X)(Y1)(Z1)(Z2)-A, DF121225BU(Z1)(Z2)-D, DF121225(X)(Y1)(Z1)(Z2)-D, DF121425(X)(Y1)(Z1)(Z2)-B, DB127015BU(Z1)(Z2)-B, DB127015(X)(Y1)(Z1)(Z2)-B, DB058015(X)(Y3)(Z1)(Z2)-A, where (X) may be S, B, P or Q, where (Y1) may be H, M, L or E, where (Y2) may be U, H, M, L or E, where (Y3) may be M or L, where (Z1) may be blank or 3, where (Z2) may be is alphanumeric combination of four digits and/or alphabets, may be A through Z, 0 through 9 or blank.

Models DB128015(X)(Y1)-(Z)-A, DF128038(X)(Y1)-(Z)-A, DB121225(X)(Y2)-(Z)-A, DF054010(X)(Y2)-(Z)-D, DF124010(X)(Y3)-(Z)-D, DF244010(X)(Y4)-(Z)-D, DF125010(X)(Y2)-(Z)-B, DF126010(X)(Y5)-(Z)-B series, where (X) may be S, B, P, Q, (Y1) may be U, H, M, L or E, (Y2) may be H, M or L, (Y3) may be U, M, L or E, (Y4) may be U, H, M or L, (Y5) may be H, M, L or E, (Z) is alphanumeric combination of five digits and/or alphabets, may be A through Z, 0 through 9 or blank.

Electric fans, Models DC0504, -1204, -1205, -1206, DF1204, -1208, -2408, -0504, -0505, -1205, -2406 followed by "S" or

TOP MOTOR TECHNOLOGY (HUIZHOU) CO, LTD

"B", followed by two alphanumeric characters.

Low voltage fans, Models DB1206, DF1209, -1212, -2409, DH1204 followed by B or S, followed by two alphanumeric characters.



Marking: Company name or trademark **TOP MOTOR** and model designation.

Last Updated on 2008-02-18

[Questions?](#)

[Notice of Disclaimer](#)

[Page Top](#)

[Copyright © 2009 Underwriters Laboratories Inc.®](#)

The appearance of a company's name or product in this database does not in itself assure that products so identified have been manufactured under UL's Follow-Up Service. Only those products bearing the UL Mark should be considered to be Listed and covered under UL's Follow-Up Service. Always look for the Mark on the product.

UL permits the reproduction of the material contained in the Online Certification Directory subject to the following conditions: 1. The Guide Information, Designs and/or Listings (files) must be presented in their entirety and in a non-misleading manner, without any manipulation of the data (or drawings). 2. The statement "Reprinted from the Online Certifications Directory with permission from Underwriters Laboratories Inc." must appear adjacent to the extracted material. In addition, the reprinted material must include a copyright notice in the following format: "Copyright © 2009 Underwriters Laboratories Inc.®"

An independent organization working for a safer world with integrity, precision and knowledge.



TOP MOTOR TECHNOLOGY (HUIZHOU) CO, LTD

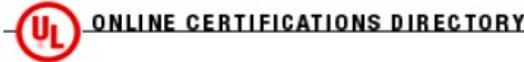

GPWV8.E157868

Fans, Electric Certified for Canada - Component

[Page Bottom](#)

Fans, Electric Certified for Canada - Component

[See General Information for Fans, Electric Certified for Canada - Component](#)

DYNAEON INDUSTRIAL CO LTD
8TH FL 35 LANE 221 GANGCIAN RD
NEIHU DIST
TAIPEI, 114 TAIWAN

E157868

DC fans, Models D(F)1206(Z)(Y1)(X1), D(F)1207(Z)(Y1)(X1), where (F) may be F or C, (Z) may be SH, BH, BA, SM, BM, BB, SL, BL, BC, SD, BE, BF, SG, BI, BJ, SK, BN, BO, SP, BQ, BR, SS, BT, BU, SV, BW, BX, SY, BY or BZ, (Y1) may be "-", 0 through 9 or A through Z, (X1) may be 0 through 9 or A through Z.

Models DF248015(S)(X)(Y)(Z)(W), DF488015(S)(X)(Y)(Z)(W), where (S) may be S, B or P, (X) may be U, H, M or L, (Y) and (Z) may be any alphanumeric character, blank, "-" or any symbol, (W) may be seven any alphanumeric character, blank, "-" or any symbol.

Models DF121225(A)(B)(C), DF121225(A)E(C), DF241225(A)(B)(C), DF128015(A)U(C), DF128015(A)(B)(C), DF128025(A)U(C), DF128025(A)(B)(C), DF128025(A)E(C), DF248025(A)U(C), DF248025(A)(B)(C), DF129225(A)(B)(C), DF129225(A)E(C), DF249225(A)U(C), DF249225(A)(B)(C), DF126010(A)(B)(C), DF246025(A)U(C), DF246025(A)(B)(C), DF126025(A)U(C), DF126025(A)(B)(C), DF126025(A)E(C), DB126015BU(C), DB126015B(B)(C), DF123010(A)(B)(C), DF053010(A)(B)(C), DF127015(A)U(C), DF127015(A)(B)(C), DF245010(A)(B)(C), where (A) may be S, B, P or Q, (B) may be H, M or L, (C) may be xxxxxxxx, where x may be A through Z, 0 through 9, "-" or blank.

Models DF122510(X)(Y2)(Z)-(M), DF124020(X)(Y2)(Z)-(M), DF244020(X)(Y1)(Z)-(M), DF126025(X)(Y3)(Z)-(M), DF246025(X)(Y3)(Z)-(M), DF121225(X)(Y1)(Z)-(M), DF124028(X)(Y3)(Z)-(M), where (X) may be S, B, P, Q, (Y1) may be H, M or L, (Y2) may be U, H, M or L, (Y3) may be U, H, M, L or E, (Z) is alphanumeric combination of five digits and/or alphabets, may be A through Z, 0 through 9 or blank, (M) may be A or B.

Models DF054010(X)(Y2)(Z1)(Z2)-A, DF054010(X)L(Z1)(Z2)-B, DF124010(X)(Y2)(Z1)(Z2)-A, DF124010(X)L(Z1)(Z2)-B, DF244010(X)(Y2)(Z1)(Z2)-A, DF125015(X)(Y1)(Z1)(Z2)-A, DF125020(X)(Y3)(Z1)(Z2)-A, DF126015(X)(Y1)(Z1)(Z2)-A, DF246015(X)M(Z1)(Z2)-A, DF246015(X)L(Z1)(Z2)-A, DF128020(X)(Y1)(Z1)(Z2)-A, DF128020(X)L(Z1)(Z2)-B, DB127015(X)(Y2)(Z)-A series, where (X) may be S, B, P, Q, (Y1) may be H, M or L, (Y2) may be U, H, M or L, (Y3) may be H, M, L or E, (Z1) may be blank or 3, (Z2) is alphanumeric combination of four digits and/or alphabets, may be A through Z, 0 through 9 or blank, (Z) is alphanumeric combination of five digits and/or alphabets, may be A through Z, 0 through 9 or blank.

Models DF125010(X)(Y)(Z)-A, DF126020(X)(Y)(Z)-A, DF246020(X)(Y)(Z)-A, DF121525(X)(Y1)(Z)-A, DF121525(X)(Y2)(Z)-B series, Where (X) may be S, B, P or Q, (Y) may be H, M or L, (Y1) may be U, H or M, (Y2) may be L or E, (Z) is alphanumeric combination of five digits and/or alphabets, may be A through Z, 0 through 9 or blank.

Models DF128025(X)(a)(Y)-A, DF121225(X)(b)(Y)-C, DF121225(X)E(Y)-C, DF127720(X)(a)(Y)-A, DF121425(X)(c)(Y)-A, DF126010(X)E(Y)-A series, where (X) may be S, B, P, Q, (a) may be H, M, L or E, (b) may be M or L, (c) may be U, H, M, L or E, (Y) is alphanumeric combination of five digits and/or alphabets, may be A through Z, 0 through 9 or blank.

Models DF054010(X)(Y1)(Z1)(Z2)-C, DF124010(X)(Y2)(Z1)(Z2)-C, DF244010(X)(Y2)(Z1)(Z2)-C, DF124020BU(Z1)(Z2)-C, DF124020(X)(Y1)(Z1)(Z2)-C, DF124028BU(Z1)(Z2)-C, DF124028(X)(Y1)(Z1)(Z2)-C, DF126025BU(Z1)(Z2)-C, DF126025(X)(Y1)(Z1)(Z2)-C, DF127015BU(Z1)(Z2)-A, DF127015(X)(Y1)(Z1)(Z2)-A, DF128025BU(Z1)(Z2)-B, DF128025(X)(Y1)(Z1)(Z2)-B, DF129225BU(Z1)(Z2)-A, DF129225(X)(Y1)(Z1)(Z2)-A, DF121225BU(Z1)(Z2)-D, DF121225(X)(Y1)(Z1)(Z2)-D, DF121425(X)(Y1)(Z1)(Z2)-B, DB127015BU(Z1)(Z2)-B, DB127015(X)(Y1)(Z1)(Z2)-B, DB058015(X)(Y3)(Z1)(Z2)-A, where (X) may be S, B, P or Q, where (Y1) may be H, M, L or E, where (Y2) may be U, H, M, L or E, where (Y3) may be M or L, where (Z1) may be blank or 3, where (Z2) may be is alphanumeric combination of four digits and/or alphabets, may be A through Z, 0 through 9 or blank.

Models DB128015(X)(Y1)-(Z)-A, DF128038(X)(Y1)-(Z)-A, DB121225(X)(Y2)-(Z)-A, DF054010(X)(Y2)-(Z)-D, DF124010(X)(Y3)-(Z)-D, DF244010(X)(Y4)-(Z)-D, DF125010(X)(Y2)-(Z)-B, DF126010(X)(Y5)-(Z)-B series, where (X) may be S, B, P, Q, (Y1) may be U, H, M, L or E, (Y2) may be H, M or L, (Y3) may be U, M, L or E, (Y4) may be U, H, M or L, (Y5) may be H, M, L or E, (Z) is alphanumeric combination of five digits and/or alphabets, may be A through Z, 0 through 9 or blank.

Electric fans, Models DC0504, -1204, -1205, -1206, DF0504, -0505, -1204, -1205, -1208, -2406, -2408 followed by "S" or

TOP MOTOR TECHNOLOGY (HUIZHOU) CO, LTD

"B", followed by two alphanumeric characters.

Low voltage fans, Models DB1206, DF1209, -1212, -2409, DH1204 followed by B or S, followed by two alphanumeric characters.



Marking: Company name or trademark **TOP MOTOR**, model designation and Recognized Component Mark for Canada,



Last Updated on 2008-02-18

[Questions?](#)

[Notice of Disclaimer](#)

[Page Top](#)

[Copyright © 2009 Underwriters Laboratories Inc.®](#)

The appearance of a company's name or product in this database does not in itself assure that products so identified have been manufactured under UL's Follow-Up Service. Only those products bearing the UL Mark should be considered to be Listed and covered under UL's Follow-Up Service. Always look for the Mark on the product.

UL permits the reproduction of the material contained in the Online Certification Directory subject to the following conditions: 1. The Guide Information, Designs and/or Listings (files) must be presented in their entirety and in a non-misleading manner, without any manipulation of the data (or drawings). 2. The statement "Reprinted from the Online Certifications Directory with permission from Underwriters Laboratories Inc." must appear adjacent to the extracted material. In addition, the reprinted material must include a copyright notice in the following format: "Copyright © 2009 Underwriters Laboratories Inc.®"

An independent organization working for a safer world with integrity, precision and knowledge.



TOP MOTOR TECHNOLOGY (HUIZHOU) CO, LTD

6.5. Electrical specifications for PWM production

USA Dynatron Corp.

Electrical Specifications for PWM production

Voltage

Fan operating voltage shall be within the range 12V \pm 1.2V.

Current

Peak fan current draw during start-up operation (with 13.2V applied, with fan operating in the free stream condition) shall not exceed 2.0 A.

Fan current spike during start-up operation (with 13.2V applied with fan operating in the free stream condition) shall be allowed to exceed 1.0 A for a duration of no greater than 1.0 sec.

Tachometer Output Signal

Fan shall provide tachometer output signal with the following characteristics:

- * Two pulses per revolution
- * Open-collector or open-drain type output
- * Motherboard will have a pull up to 12V, maximum 13.2V

PWM Control Input Signal

The following requirements are measured at the PWM(control) pin of the fan cable connector: PWM Frequency: Target frequency 25kHz,

acceptable operational range 21 kHz to 28 KHz

Maximum voltage for logic low: VIL=0.8V

Absolute maximum current sourced: I_{max}=5mA(short circuit current)

Absolute maximum voltage level: V_{max}=5.25V(open circuit voltage)

Fan Speed Control

1.1 Maximum Fan Speed Requirements

The maximum fan speed shall be specified for the fan model by the vendor and correspond to 100% duty cycle PWM signal input.

1.2 Minimum Fan Speed Requirements

The vendor shall specify the minimum RPM and the corresponding PWM duty cycle. This specified minimum RPM shall be 30% of maximum RPM or less. The fan shall be able to start and run at this RPM. To allow a lower specified minimum RPM, it is acceptable to provide a higher PWM duty cycle to the fan motor for a short period of time for startup conditions. This pulse should not exceed 30% maximum RPM and should last no longer than 2 seconds.

TOP MOTOR TECHNOLOGY (HUIZHOU) CO, LTD

USA Dynatron Corp.

1.3 Fan Speed Response PWM Control Input Signal

The PWM input shall be delivered to the fan through the control signal on Pin4. Fan speed response to this signal shall be a continuous and monotonic of the duty cycle of the signal, from 100% to the minimum specified RPM. The fan RPM (as a percentage of maximum RPM) should match the PWM duty cycle within $\pm 10\%$. If no control signal is present the fan shall operate at maximum RPM.

Figure 1 Fan speed Response to PWM Control input Signal

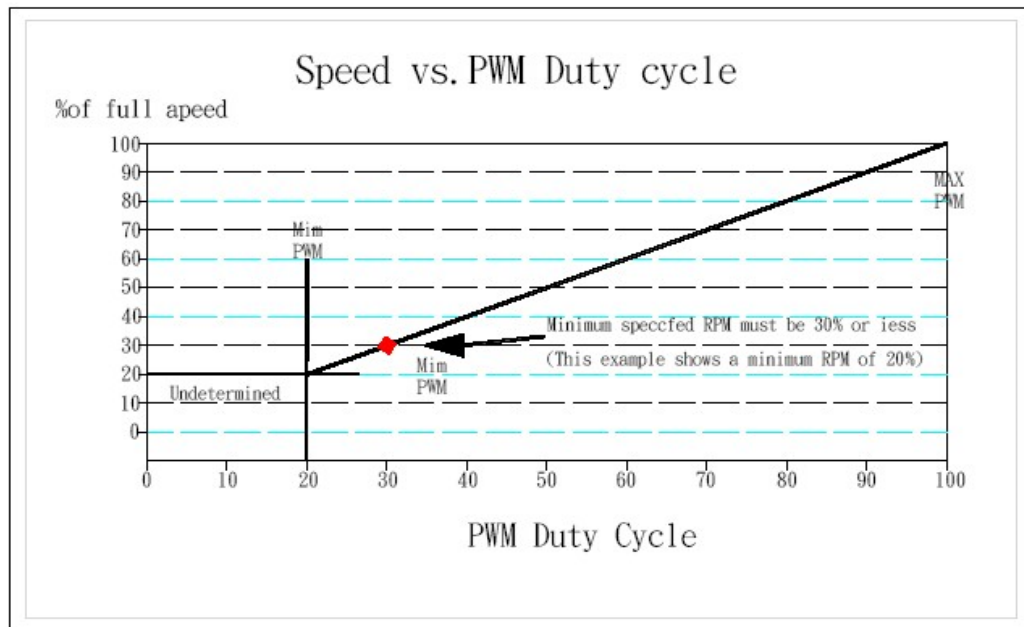

1.4 Operation Below Minimum RPM

For all duty cycles less than the minimum duty cycle, the RPM shall not be greater than the minimum RPM. The following graphs and definitions show three recommended solutions to handle PWM duty cycles that are less than the minimum operational RPM, as a percentage of maximum.

Reference resource by Intel's 4-wire PWM Fan controlled specification.