

MIC-8122 User's Manual



with Microsoft® Windows® 10
with Microsoft® Windows® 11
with Ubuntu

Table of Contents

Chapter 1. About this Manual.....	1
1.1. Manual version revision record	1
1.2. Copyright Statement	1
1.3. Disclaimer	1
1.4. Trademark.....	1
1.5. Warranty terms.....	1
Chapter 2. Product Overview	4
2.1. Overview of the MIC-8122 function	4
Chapter 3. Product Presentation	6
3.1. Product Appearance.....	6
3.2. Appearance size diagram.....	6
3.3. Product specification introduction.....	7
Chapter 4. IO Panel description	10
4.1. MIC-8122 panel is shown below.....	10
4.2. Serial communication port (simply "serial port")	10
4.3. DC port	10
4.4. Remote	11
4.5. Display Output (VGA/HDMI/DP).....	11
4.6. SIM Block.....	11
4.7. Ethernet Interface (LAN)	11
4.8. USB Interface.....	12
4.9. Audio Interface (Line-out, Mic-in)	12
4.10. Antenna interface	12
4.11. Explanation of indicator lights	13
4.12. PCIe/PCI.....	13
Chapter 5. Direction for Use.....	15
5.1. OOBA	15
5.2. Note the following points when unpacking the equipment:	15
5.3. Work environment.....	15
5.4. Installation Steps.....	16
5.5. Gigabit Network Card Camera Configuration	16
Chapter 6. BIOS Setup	18
6.1. BIOS Explain.....	18
6.2. Go to the CMOS Setup settings	18
6.3. Main menu function.....	19
6.4. Main (Standard CMOS, Function Settings)	20
6.5. Advanced (Advanced BIOS, Function Settings)	21
6.6. Chipset (Chipset Performance Settings)	22
6.7. Security (Set the administrator / user password)	23
6.8. Boot (boot settings)	24
6.9. Save & Exit (Save & exit options).....	25
Chapter 7. Troubleshooting Guide	27
7.1. Boot Abnormal Q&A.....	27
Chapter 8. After-Sale Service	30

Chapter 1. About this Manual



Chapter 1. About this Manual

1.1 Manual version revision record

Date	Version number	Revise Content	Modified By
2024/07/15	V1.0.	Prepare the manual for the first time	LWT

1.2 Copyright Statement

This manual is the use manual of MIC-8122 series products. This manual products and their related documents are owned by Darveen Co., Ltd. (hereinafter referred to as "Darveen"), with all of the interpretation rights.

If the manual is different from the latest product, please contact our FAE. We will not be responsible for any direct, indirect, intentional or unintentional damage or hazards caused by improper installation or use.

This manual without the authorization of Darveen shall not, in any way, in any form to copy, copy, translation or transfer any commercial purposes, except for the non-commercial purposes or personal use of download or printing (prohibited to modify the manual, and must indicate the ownership of the manual).

1.3 Disclaimer

This manual only describes the use of embedded industrial computers manufactured by Darveen. If you use the product, unless otherwise mandatory by law, Darveen shall not bear any express or implied warranty or guarantee for the product for the use of this manual, including but not limited to the following:

- (1) This product will meet your needs or expectations;
- (2) The information contained in this product is real-time and correct;
- (3) This product does not infringe on the rights of any others

You clearly understand and agree that, in addition to the law, breach, its subsidiaries, agents, partners, relationships, managers, employees and authorized person need not be responsible for you any direct, indirect, special, derivative, incidental, punitive damage (including but not limited to the goodwill, profit, use data damage or other intangible loss).

With an extremely rigorous and scientific attitude, the manual is compiled, but the technology is constantly developing, and the speed of product upgrading is far beyond the speed of the preparation, so we reserve the right to modify it at any time without notification.

1.4 Trademark

The ownership of the trademark involved in this manual, Darveen Technology Limited , is owned by the holder of Darveen Technology Limited No one shall use it without their permission.

1.5 Warranty terms

The default product warranty period is 1 year. In case of special circumstances, the contract signed by both parties shall prevail

Safety guidance for installed and use

1. Please read carefully and keep this manual properly before use.
2. Keep the plate card dry and packed intact before installation, ensuring that the equipment is placed in a stable plane, and an accidental fall or flip may cause equipment failure or damage.
3. In order to avoid unnecessary damage caused by frequent turning to the product, wait at least 30

seconds before shutdown of the machine. If the equipment is not used for a long time, disconnect the power cord to avoid the equipment being damaged by instantaneous voltage.

4. The opening slot of the chassis is used for ventilation to avoid overheating of the parts in the chassis. Do not mask or block such openings.

5. Before connecting the product to the power supply, confirm the supply voltage and adjust the voltage to 220V.

6. Protect the power cord from trampling or other accidents that may cause sudden power failure, and do not stack anything on the power cord.

7. Unplug the power cord before unplugging any expansion card or module.

8. Note to all the notes and warnings mentioned in the manual.

9. Do not make any changes or modifications to this product. If there is any abnormal use of the equipment, please find a professional personnel for safety reasons.

10. Please do not place or store the product at an ambient temperature above 60°C (140F) as it will cause harm to the product.

11. If the battery is not replaced properly, it can cause a danger. Be sure to use the same model or equivalent battery as recommended by the manufacturer.

Chapter 2. Product Overview



Chapter 2. Product Overview

Industrial control machine (Industrial Personal Computer, IPC) is the industrial control computer, is a use of bus structure, the production process and electromechanical equipment, process equipment for detection and control of the tool general name.

Industrial control machine has important computer attributes and characteristics, such as computer CPU, hard disk, memory, peripherals and interfaces, and operating system, control network and protocols, computing power, friendly man-machine interface.

The industrial control machine often operates in a harsh environment, and the safety requirements for data are higher. Therefore, the industrial control machine is usually reinforced, dust proof, moisture proof, corrosion proof, radiation prevention and other special designs.

2.1 Overview of the MIC-8122 function

The MIC-8122 is a modular industrial computer with 10th/11th Gen Intel® Core™ i3/i5/i7/i9, Pentium®, and Celeron® processors. It offers extensive connectivity options, expansion capabilities, control interfaces, and flexible display configurations, making it a versatile and reliable choice for industrial applications.

* Table 2.1-1 MIC-8122 Functional Overview table

Product Keywords	Modular Industrial Computer with 10th Gen Intel® Core™ i3/i5/i7/i9, Pentium®, Celeron® Processor
Product Features	<ul style="list-style-type: none"> • 10th Gen Intel® Core™ i3/i5/i7/i9, Pentium®, Celeron® Processor • 6x COM(5RS-232/485), 3x LAN, 8x USB • 2 x PCI, 1 x PCIe X16, 1 x PCIe X4 • 1x DP, 1x VGA, 1x HDMI • 2x M.2 M-Key 2280 ,1x M.2 E-Key 2230 ,1x M.2 B-Key 3052 • 24V DC power input

Chapter 3. Product Presentation



Chapter 3. Product Presentation

3.1 Product Appearance

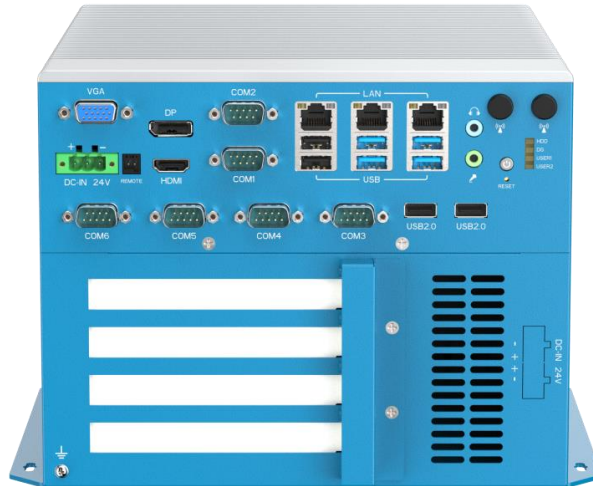

* Figure 3.1-1 front view of MIC-8122

3.2 Appearance size diagram

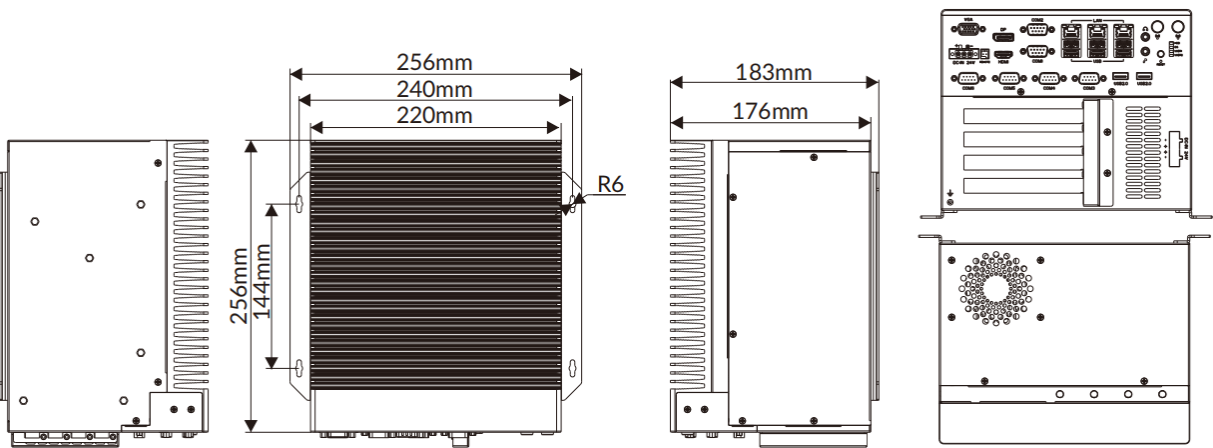

* Figure 3.2-1 MIC-8122 dimensional drawing

3.3 Product specification introduction

* Table 3.3-1 MIC-8122 product specification

Model No.	MIC-8122
Short Description	Modular Industrial Computer with 10th Gen Intel® Core™ i3/i5/i7/i9, Pentium®, Celeron® Processor
Features	10th Gen Intel® Core™ i3/i5/i7/i9, Pentium®, Celeron® Processor
	6x COM(5xRS-232/485), 3x LAN, 8x USB
	2 x PCI, 1 x PCIe X16, 1 x PCIe X4
	1x DP, 1x VGA, 1x HDMI
	2x M.2 M-Key 2280 ,1x M.2 E-Key 2230 ,1x M.2 B-Key 3052
	24V DC power input
Overview	The MIC-8122 is a modular industrial computer with 10th Gen Intel® Core™ i3/i5/i7/i9, Pentium®, and Celeron® processors. It offers extensive connectivity options, expansion capabilities, control interfaces, and flexible display configurations, making it a versatile and reliable choice for industrial applications.
Specifications	
Model No.	MIC-8122
System	
CPU	Comet lake S i3/i5/i7/i9
CPU TDP	65W
Chipset	H420E
Memory	2x DDR4 SO-DIMM up to 64GB
Storage	2x M.2 2280 SATA
BIOS	AMI 128Mbit SPI Flash
TPM	1x SPI (optional)
Watchdog Timer	Software programmable supports 256 levels system reset
I/O Ports	
USB Port	4x USB 2.0, 4x USB3.0
Serial Port	6x COM (5xRS-232/485)
Ethernet	1x Intel® I219-LM, 2x Intel® I210-AT
Display Port	1x DP, 1x VGA, 1x HDMI
SIM Card Slot	1x SIM
Antenna Hole	6x SMA-type
Expansion Slot	
PCI/PCIe	2 x PCI, 1 x PCIe X16, 1 x PCIe X4
M.2	2x M.2 M-Key 2280,1x M.2 E-Key 2230 ,1x M.2 B-Key 3052
RF Communication	
Wi-Fi	1x M.2 2230 E-Key (PCIe AxMac Wi-Fi 6)
Cellular	1x M.2 3052 B-Key (USB3.0)
Bluetooth	1x M.2 2230 E-Key (PCIe AxMac Wi-Fi 6)

GNSS	1x M.2 3052 B-Key (USB3.0)
Audio	
Audio	Mic in, line out
Power	
Remote On/Off	Power 2-Pin remote
DC Input	24VDC
Input Type	1x 3-pin terminal block connector
Power Mode	AT/ATX
Operating System	
Windows	Windows 10, Windows 11
Linux	Ubuntu
Mechanical	
Dimensions (WxDxH)	220 x 256 x 176mm(8.66 x 10.08 x 6.93 inches)
Weight (N.W.)	5.6kg(12.35 lb)
Mounting	Wall-mount
Material	Aluminum alloy
Environment	
Operating Temperature	-10 to 50°C (14 to 122° F, with SSD Airflow 0.7m/s)
Storage Temperature	-40 to 80°C (-40 to 176° F)
Relative Humidity	10% to 95% (non-condensing)
Certification	
EMC	CE, FCC Class A
I/O Interfaces	Graphic
Dimensions	Graphic
Part No.	MIC-8122
	3xLAN, 6xCOM(5xRS-232/485), 8x USB, 2 x PCI, 1 x PCIe X16, 1 x PCIe X4, 1xDP, 1xVGA, 1xHDMI

Chapter 4. IO Panel description



Chapter 4. IO Panel description

4.1 MIC-8122 panel is shown below

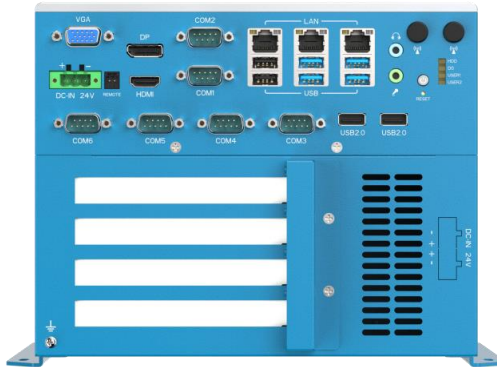

* Figure 4.1-1 MIC-8122 panel diagram

4.2 Serial communication port (simply "serial port")

Equipped with 2 DP9 serial ports, COM2 is RS232, COM1/COM3/COM4/COM5/COM6 can be switched to RS485 or RS232.

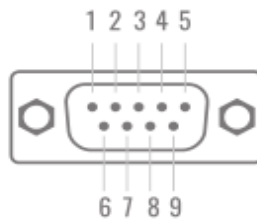

* Figure 4.2-1 serial port diagram of DP 9

* Table 4.2-1 Explanation of serial definition for DP 9

PIN	Signal name	PIN	Signal name
1	DCD/RS485+	2	RXD/RS485-
3	TXD	4	DTR
5	GND	6	DSR
7	RTS	8	CTS
9	RI	10	NC

4.3 DC port

Equipped with Input 24V, 1x 3-pin terminal block connector as shown in Fig.

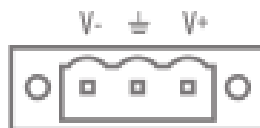

* Figure 4.3-1 DC port diagram



Note: Use the adapter or switch power supply supporting the equipment. Do not connect more than 36V power supply, otherwise it will cause the motherboard over voltage to burn!!!

4.4 Remote

Equipped with 1 set of remote switches, you can achieve power on/off. as shown in the figure.

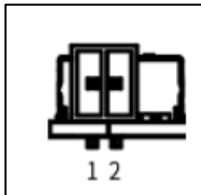

PIN	Signal	Description
1	PBTN	Power on or Power off
2	GND	

* Figure 4.4-1 Remote Interface Drawing

4.5 Display Output (VGA/HDMI/DP)

Equipped with 1 HDMI, 1 DP, and 1 VGA display interface, DP can achieve 4K high-definition signal transmission at high speed, and also has good anti-interference ability. As shown in the figure.

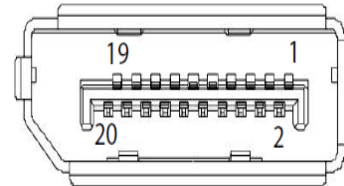
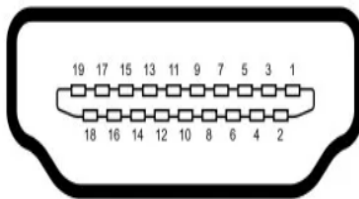
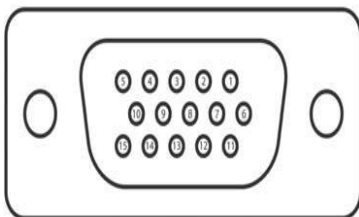

* Figure 4.5-1 VGA Interface * Figure 4.5-2 HDMI Interface * Figure 4.5-3 DP Interface Figure

4.6 SIM Block

Built-in M.2 BCopyright Statement .-key 3052 interface, support for 5G communication, compatible with 4G.

4.7 Ethernet Interface (LAN)

With 3 Ethernet interfaces, as shown in the figure, and supports 10 / 100 / 1000Mbps. The port uses the standard RJ-45 jack with LED indicators indicating the connection and transmission status. See



the chart below for the indicator light representation and the machine status.

* Figure 4.7-1 Ethernet interface diagram

* Table 4.7-1 LED indicator light definitions table

LED pilot lamp			
Left side LED			offside LED
close	orange	green	green
10Link	100Link	1000Link	transfer

4.8 USB Interface

Equipped with 4 USB3.0 and 4 USB 2.0 interfaces, the USB interface supports the plug and play function, allowing the user to connect or disconnect the device at any time, as shown in the chart.



* Figure 4.8-1 USB interface diagram

Table 4.11-1 USB interface definition table

Pin	Signal
1	Vbus
2	D-
3	D+
4	GND

4.9 Audio Interface (Line-out, Mic-in)

With 23.5 stereo audio interfaces, which support line output and line input. The audio chip controller is ALC662, and the interface is shown in the chart



* Figure 4.9-1 Audio interface diagram

Table 4.12-1 Audio interface definition table

icon	description
	Line-out
	Mic-in

4.10 Antenna interface

6xSMA-type

4.11 Explanation of indicator lights

* Table 4.11-1 Machine indicator table

icon	pigment	State instructions	description
	blue	mains switch	DC power supply off: off / DC power supply on: always on
HDD	Citrus sinensis	The SATA hard disk detection	Yes: Chang bright / work: flashing / no: out
D G	Citrus sinensis	Memory bar indicator light	None: Chang bright / yes: out
USER1	Citrus sinensis	Standby indicator light	Standby: Blink / Work: Go off
USER2	Citrus sinensis	Watchdog indicator light	Work: Chang-on / Stop: go out

4.14 RESET

Equipped with 1 ClearCMOS key, the icon is shown in Fig.



* Figure 3.15-1 The Clear CMOS icon

The COMS is powered by the button battery on the motherboard, and clearing the CMOS causes the permanent elimination of previous system settings to the original (factory settings) system settings.

The setting steps are as follows:

1. Turn off the industrial computer and disconnect the power supply;
2. Use the slender pin, press the RESET key for 3-5 seconds, and then release;
3. Wait for 30 seconds to start the industrial computer, press [Del] to enter the BIOS setting, and reconfigure it (the default value is not required);
4. Save and exit the settings.



Note:

1. Please do not remove cmos when the controller is charged to avoid damage to the equipment!
2. PCIe/PCI: With a combination of 2 PCIe or 2 PCI or 1 PCIe and 1 PCI slot, you can support a standard PCIe / PCI extension card.

4.12 PCIe/PCI

Equipped with a combination of 2 x PCI, 1 x PCIe X16, 1 x PCIe X4, it can support standard PCIe/PCI expansion cards.

Chapter 5. Direction for Use



Chapter 5. Direction for Use

This section provides a simple operation description for the normal use of MIC-7311 series products, introducing the working environment, installation steps and the basic operation of the system protection functions of industrial computers.

5.1 OOBA

Before opening the package, please check whether the product model indicated on the outer package is consistent with the product model ordered. After opening the package, carefully check whether the accessories are complete according to the packing list or the order contract. If the surface of the industrial computer is damaged, or the product content is not consistent, please do not use it, and contact the dealer immediately.



Note:

In order to prevent electrostatic damage to industrial computers, please touch the effective grounded metal object to release the electrostatic charge carried by the body, and wear anti-static gloves.

5.2 Note the following points when unpacking the equipment:

1. It is recommended that you do not discard the original packaging materials. Please keep the original packaging materials for use when transporting the equipment again.
2. Check the delivered equipment for any obvious damage caused during transit.
3. Confirm whether the received goods include complete equipment and accessories. refer to the packing list. If there is any discrepancy or transportation damage, please contact the relevant business or customer service personnel.

Table 5.2-1 Machine packing list table

List of binning		
order number	type	quantity
1	The MIC-7311 series of industrial computers	A
2	Adapter, power supply cord	A set
3	Wall hanging kit	A set
4	Install wall screw	Four
5	IO terminal (with antenna rod if configured with antenna)	Group 1

5.3 Work environment

1. Industrial computers need to be far away from the high-power and strong electromagnetic interference of electrical appliances and the environment;
2. The working environment temperature should be between 0 degrees and 55 degrees Celsius;
3. The power supply voltage shall be kept between 200V and 240V.

5.3 Dead Work

Before installation, please prepare the relevant items, such as:

1. MIC-7311 series of industrial computers, and related power supply and cables;
2. Display, and the display cable between the display and the industrial controller;
- 3.USB mouse and keyboard;
4. PLC, camera and corresponding connecting lines;
5. Power supply.

5.4 Installation Steps

Hardware connection:

- 1.Connect the equipped display to the industrial computer display interface;
- 2.Connect keyboard, mouse and other to industrial computer USB interface;
- 3.Connect other hardware, such as PLC and camera, according to the corresponding interface;
- 4.Power adapter access 220V voltage, power on.

5.5 Gigabit Network Card Camera Configuration

1. Confirm that the camera is connected to the power supply and that the camera is connected to the industrial computer.
2. Close the firewall, control panel-> Windows Defender-> Set-> Implement protection-> Remove hook and administrator-> Enable Windows Defender-> Remove hook.
3. Turn on camera software.

Chapter 6. BIOS Setup



Chapter 6. BIOS Setup

6.1 BIOS Explain

BIOS is a basic input and output control program stored in flash memory (Flash Memory), which is a bridge between the host board and the operating system, responsible for managing the relevant parameter setting between the host board and the expansion card. When the industrial computer is activated, it is controlled by the BIOS program, a POST self test, which detects all hardware devices and confirms the synchronous hardware parameters; when all tests are completed, it transfers control of the system to the operating system (OS). Since BIOS is the only channel connecting hardware and software, how to properly set the parameters in BIOS will determine whether your computer is running stably and working in the best state, so the correct setting of BIOS is the key factor in the stability of the system, and then ensure that the system performance can reach the best state.

CMOS Setup The set data will be stored in the CMOS SRAM built on the main board. When the power is off, the lithium battery on the mainboard continues to power the CMOS SRAM. The BIOS Settings utility allows you to configure the:

1. Hard disk drives and peripherals;
2. Video display type and display options;
3. Cryptoguard;
4. Power management characteristics.



Note:

Since the motherboard BIOS version is constantly upgraded, the BIOS description in this manual is for reference only. We do not guarantee the consistency of the relevant content in this specification with the information you obtain.

6.2 Go to the CMOS Setup settings

When the industrial computer is started, the BIOS enters the startup self-test (Post) program. The self-test program is a series of diagnostic programs fixed in the BIOS. After the execution of the self-test program is completed, there is no error. If you want to enter the BIOS, please press the DEL key or ESC key until you enter the BIOS interface. If this message disappears before you respond, you can turn it off and then restart your computer, or you can also press <Ctrl> + <Alt> + <Delete> to restart the computer.

6.2.1. Function keys and auxiliary instructions.

Table 6.2-1 Function keys and auxiliary instructions

↑ (Up key)	For moving to the previous project
↓ (Down key)	For moving to the next project
← (Left key)	For items to move to the left
→ (Right button)	For items to move to the right
ESC key	Used to exit the current screen
Enter key	Used to select confirmation
+ key	Use to change the setting state, or to add the numerical content
-key	Use to change the set state or reduce numerical content

F1 key	Used to display help
F2 key	To load the last set value
F3 key	Values used for onload optimization
F4 key	To store the settings and leave the CMOS SETUP program

6.2.2. Auxiliary description of the main picture:

When you are in the Setup main screen, as the options move, the main settings of the corresponding options appear below.

To leave the secondary description window, just press [ESC].

6.3 Main menu function

When you enter the CMOS setup setting menu, you can see the main menu as shown in the figure at the top of the screen. In the main menu, you can choose different setting options and press the left and right direction keys to select. After selecting the submenu, the detailed setting options will be displayed below.

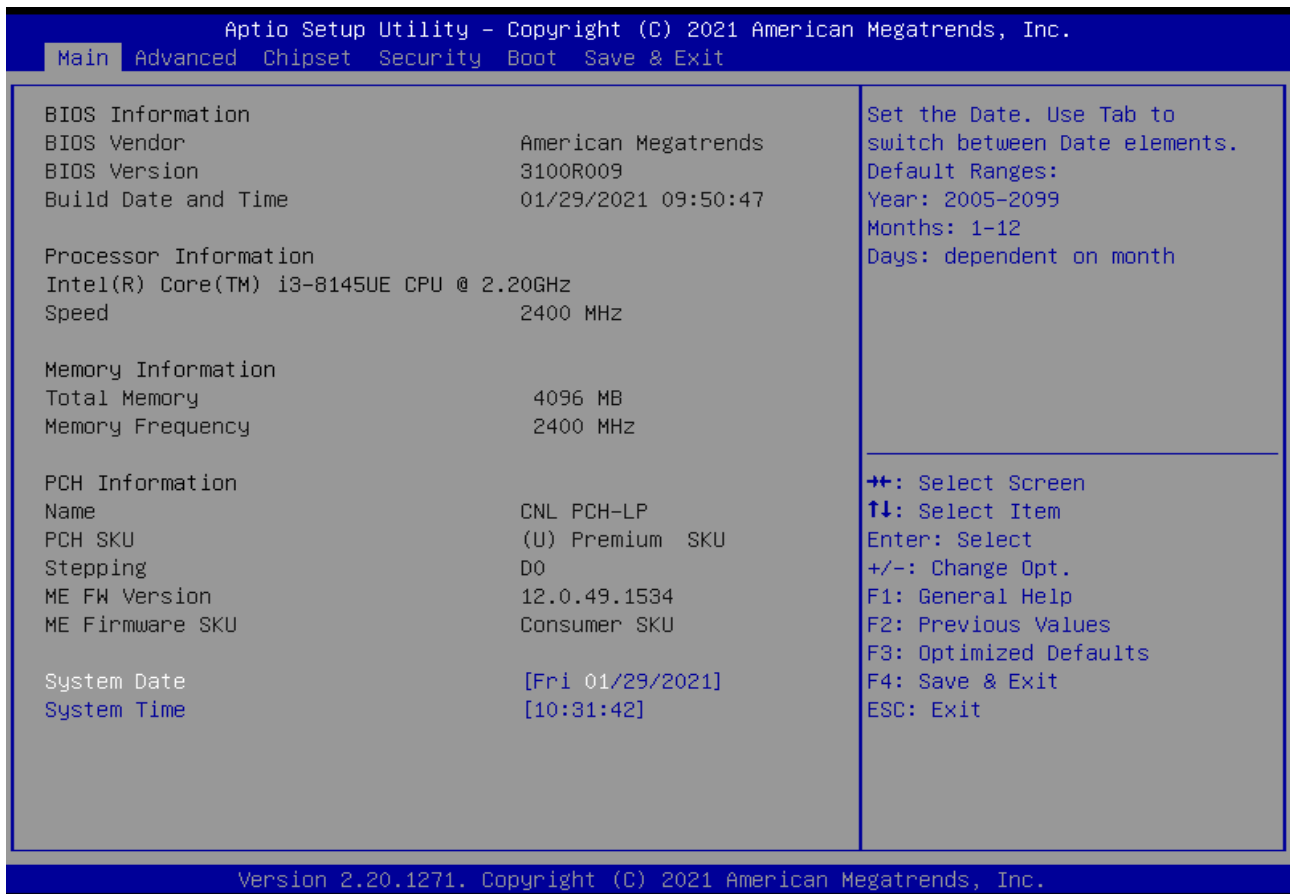

* Figure 6.3-1, the main menu interface

1. Main (Standard CMOS, function setting):
Set the date, the time, etc.;
2. Advanced (Advanced BIOS, function settings):
Set special functions provided by BIOS, such as CPU, USB, PCI, port, etc.;
3. Chipset (Chipset Performance Settings):
Set North Bridge, South Bridge and other equipment options;

- 4. Security (Set the administrator / user password);
- 5. Boot (start-up item configuration feature);
- 6. Save & Exit (Save & Exit option): This option includes discard change / do not save exit / save exit, etc.

6.4 Main (Standard CMOS, Function Settings)

* Figure 6.4-1 The Main Menu

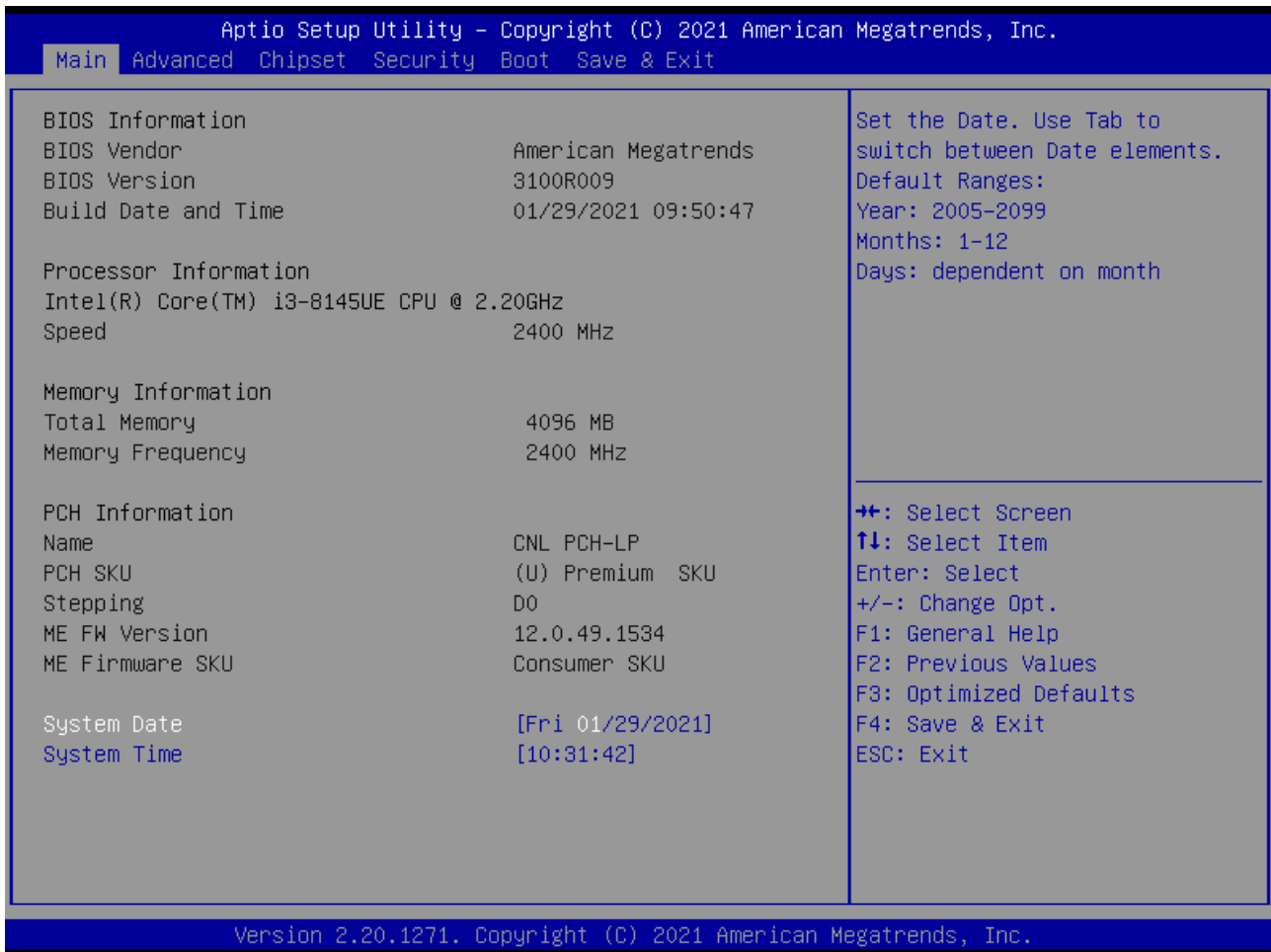

- 1. System Date (mm: dd: yy) (date setting)
Set the date in the computer, the format is "week month / day / year";
- 2. System Time (hh: mm: ss) (time setting)
Set the time in the computer as "hours / minute / s".

6.5 Advanced (Advanced BIOS, Function Settings)

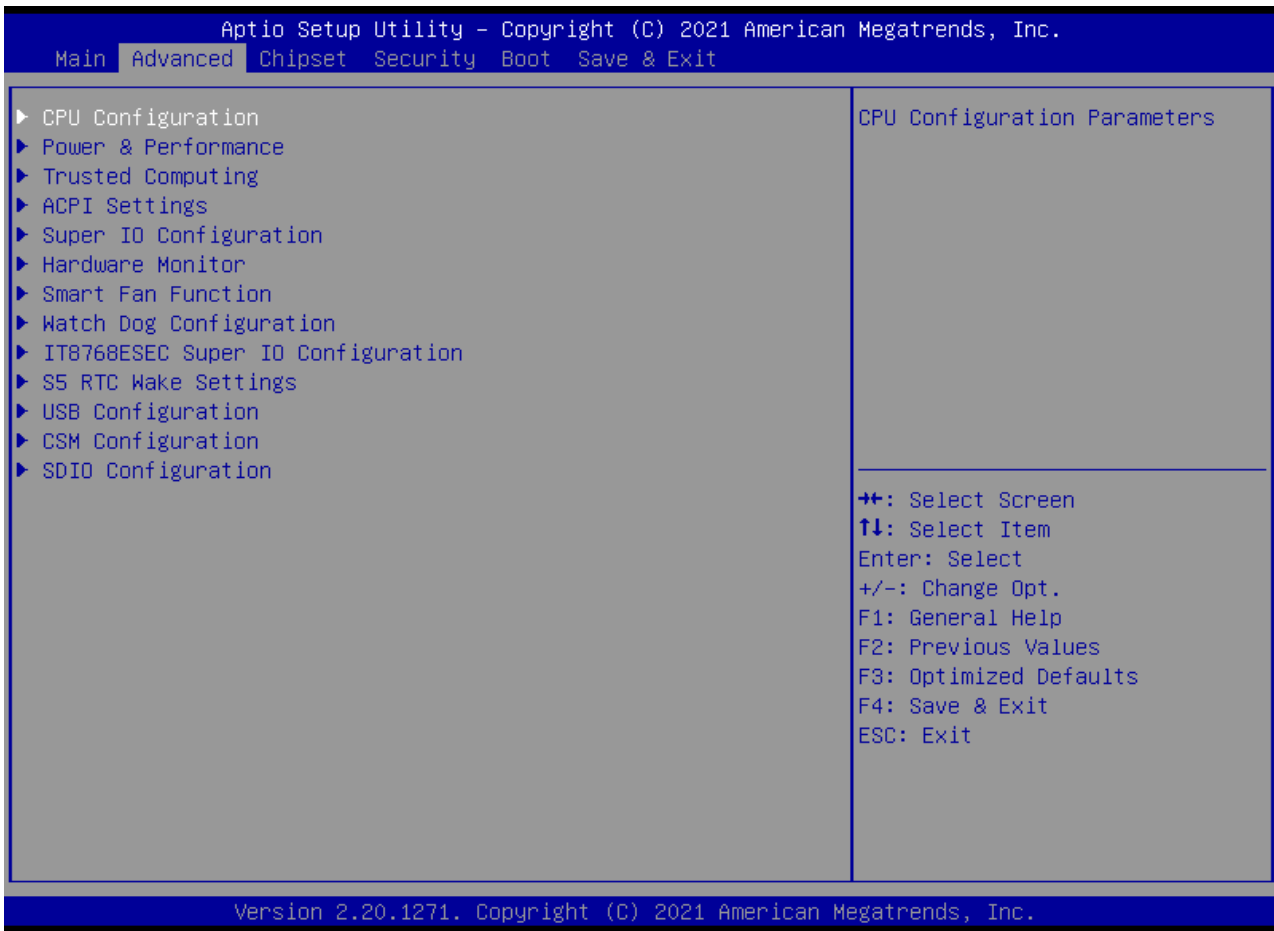

* Figure 6.5-1 The Advanced Menu

1. CPU Configuration: CPU configuration
2. Power & Performance: Power supply and performance
3. Trusted Computing: Trusted calculation
4. ACPI Settings: ACPI settings
5. Super IO Configuration: Advanced IO port configuration
6. Hardware Monitor: Hardware monitoring
7. Smart Fan Function: Intelligent fan function.
8. Watch Dog Configuration: Watch dog configuration.
9. IT8786ESEC Super IO Configuration: Advanced IO port configuration of IT8786ESEC chip.
10. S5 RTC Wake settings: S5 RTC Wake settings.
11. USB Configuration: USB configuration.
12. CSM Configuration: CSM configuration.
13. SDIO Configuration: Security digital IO port setting.

6.6 Chipset (Chipset Performance Settings)

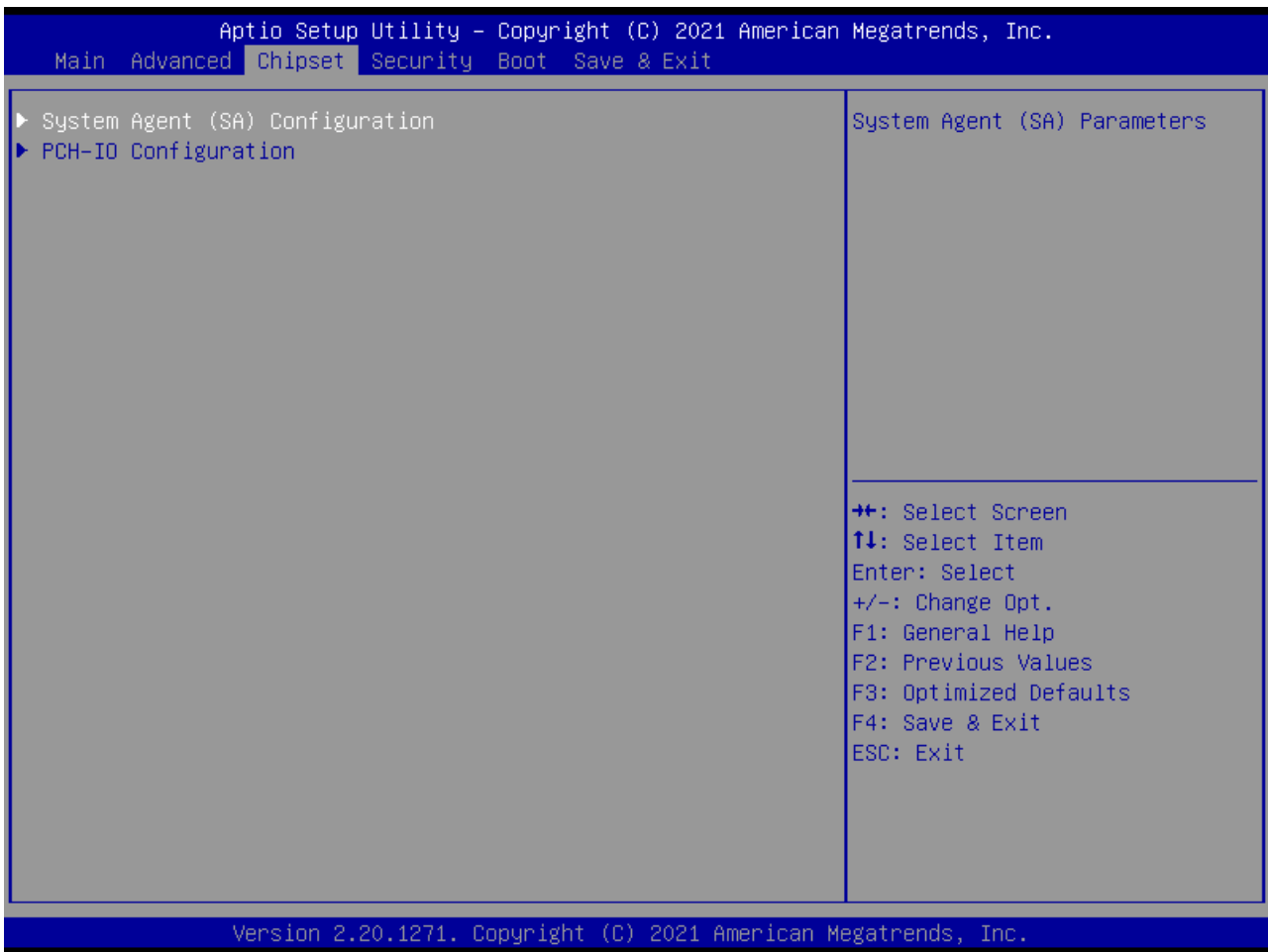

* Figure 6.6-1 The Chipset Menu

3. System Date (mm: dd: yy) (date setting)

Set the date in the computer, the format is "week month / day / year";

4. System Time (hh: mm: ss) (time setting)

Set the time in the computer as "hours / minute / s".

6.7 Security (Set the administrator / user password)

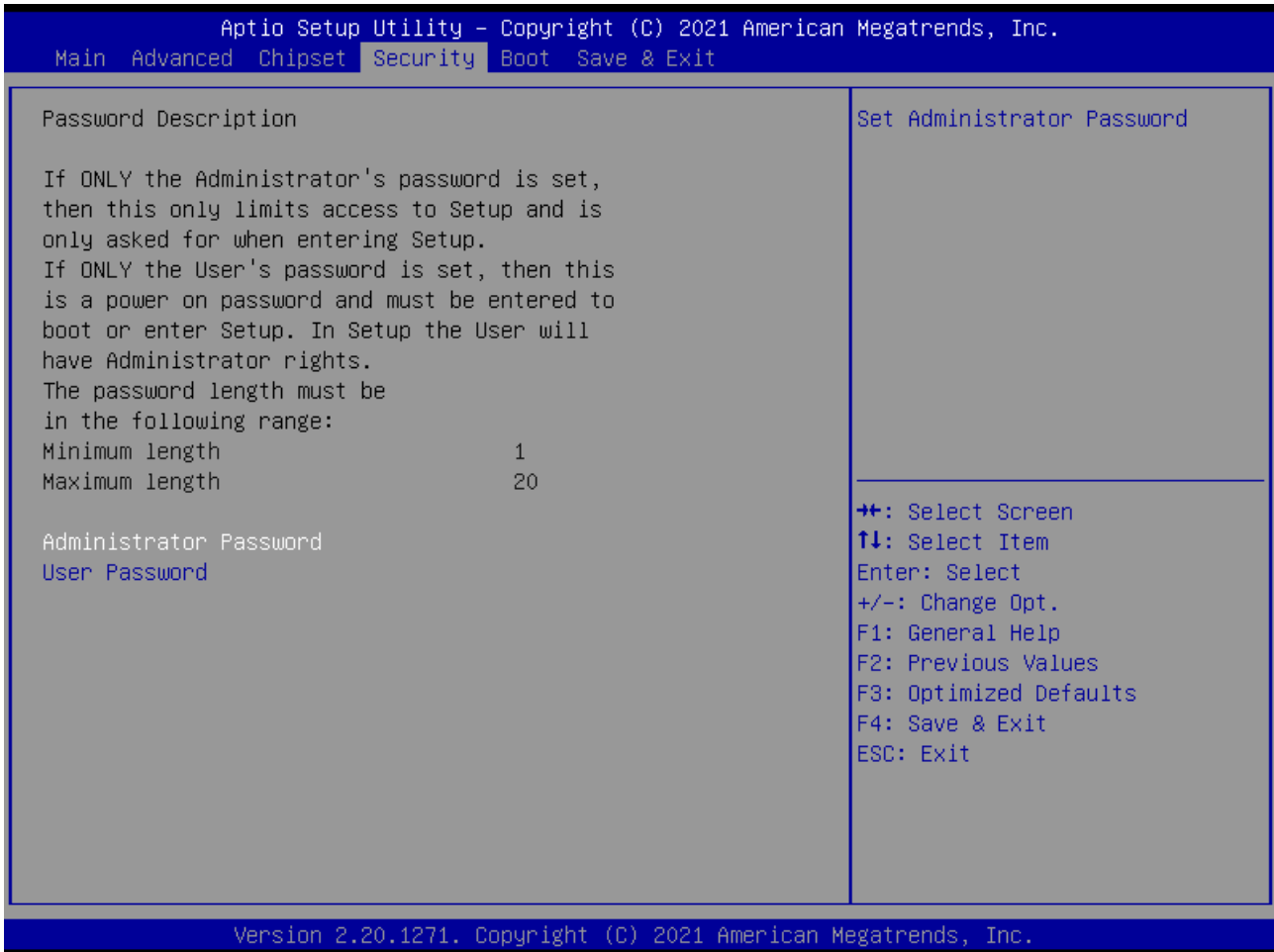

* Figure 6.7-1 The Security Menu

1. Administrator Password: Set the super user password option, which has the highest permission. When you select this feature, the following information will appear: Create New Password * * * * *. Enter a password, up to twenty characters, and then press the <Enter> key. BIOS requires to enter the same password again. After entering, BIOS saves the set password. Once you use the password function, you will be asked to enter the password before you enter the BIOS settings. This prevents any unauthorized use from your industrial computer.

2. User Password: Set the user password option, this password permission will be limited, some settings cannot be changed.

When you select this feature, the following information will appear: Create New Password * * * * *. Enter a password, up to twenty characters, and then press the <Enter> key. BIOS requires the same password again. After the input, BIOS saves the set password. Once you use the password function, you will be asked to enter the password before you enter the BIOS settings.

6.8 Boot (boot settings)

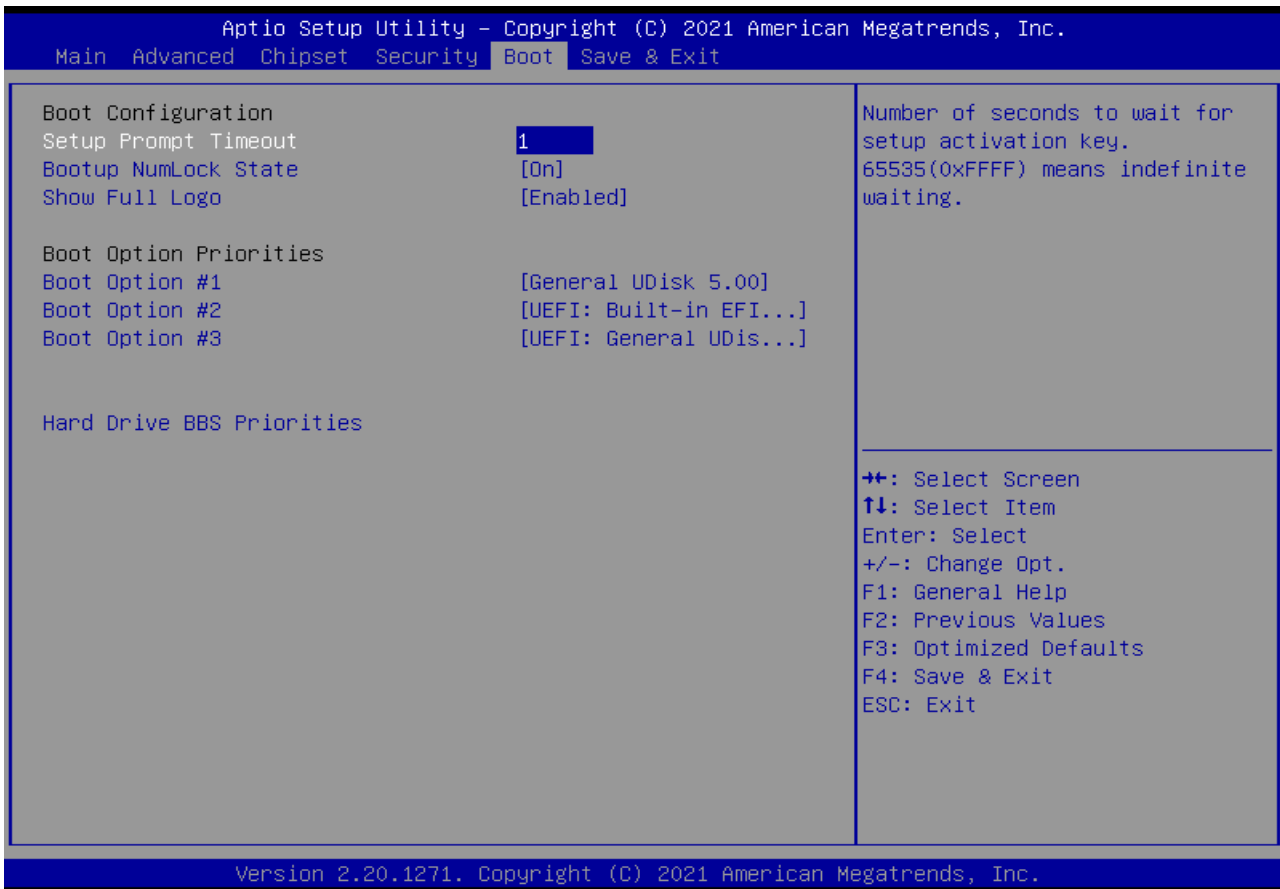

* Figure 6.8-1 The Boot Menu

Boot Configuration

Setup Prompt Timeout: Set the prompt time

Power-on display of the POST stay time, the larger the value, the longer the stay time.

Bootup NumLock State: Num Lock key status after system startup

The settings are: [On] / [Off]. This option specifies the status of the Num Lock key on the keyboard after the industrial computer starts.

Quiet Boot: static start

Setpoints are: [Disabled] / [Enabled]. This option specifies whether the LOGO is displayed when the industrial computer starts up.

Boot Option Priorities: Priority start option

Boot Option # 1: First start option

Boot Option # 2: Second startup option

Boot Option # 3: Third startup option

Fast Boot: static start

Setpoints are: [Disabled] / [Enabled].

Hard Drive BBS Priorities: Hard disk drive startup priority setting

6.9 Save & Exit (Save & exit options)

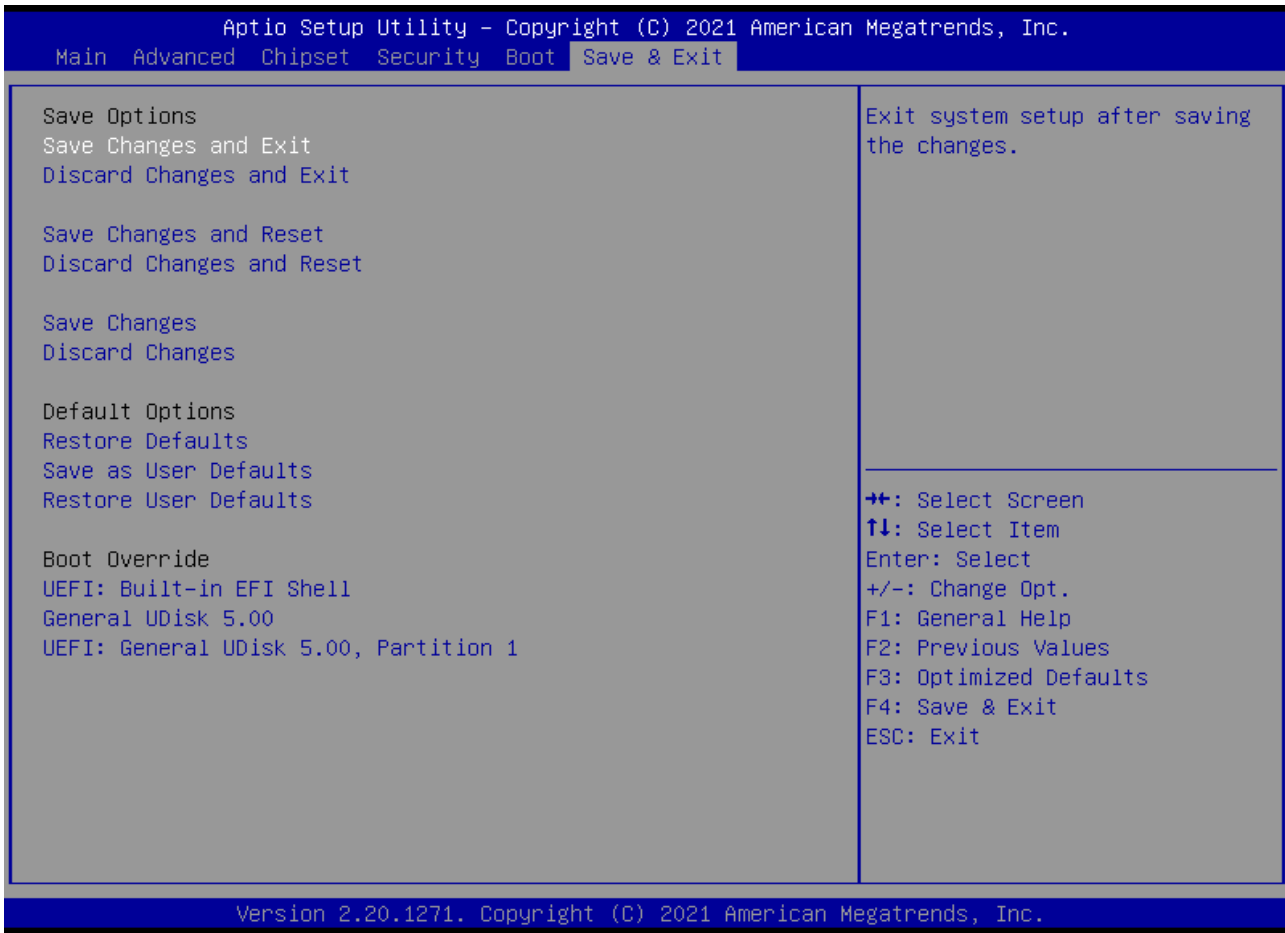

* Figure 6.9-1 Save & Exit Menu

Save options (Save Options)

Save Changes and Reset: Save the changes and restart them

Discard Changes and Reset: Discard the changes and restart

Default Value Options (Defaults Options)

Restore Defaults: Load the default optimization value (Load Optimal Defaults)

This option in the main menu allows the user to restore all the BIOS options to the optimized value. The default value is the default value set to optimize motherboard performance. If you select YES and press Enter, you can store all setting results to CMOS SRAM and leave the BIOS setting program; if you do not want to store, select NO can go back to the main menu.

Save as User Defaults: Save as the user default value

Restore as User Defaults: Restore to user default

Boot Override: Direct boot star

Chapter 7. Troubleshooting Guide



Chapter 7. Troubleshooting Guide

7.1 Boot Abnormal Q&A

Q1: After pressing the power button to start on, the power indicator is not on

1. Answer A: Check whether the industrial computer is connected correctly, and whether the power socket is charged;
2. Answer B: Check the industrial computer power adapter, plug and unplug the power cord, display data cable and keyboard mouse cable, confirm that the display and host connection is correct;
3. Answer C: Check whether the positive and negative electrodes of the power plug are reversed.
- 4.

Q2: The power indicator is on and the display is not displayed

1. Answer A: Check the display power supply and switch;
2. Answer B: Check whether the display data line is in bad contact;
3. Answer C: If using Display Port or VGA converter, replace other brand converters;
4. Answer D: Observe the keyboard and mouse indicator, if the keyboard indicator, mouse indicator is on, replace the monitor screen.

Q3: After the boot of the motherboard can not self-check success

1. Answer: Press [Del], key to reset CMOS, or clear CMOS.

Q4: The mouse and keyboard cannot be used after the boot

1. Answer A: To see whether the keyboard lock is locked, remove the keyboard lock;
2. Answer B: If not, check whether the connection with the main board and the keyboard and mouse are connected correctly;
3. Answer C: Check whether there is a keyboard mouse one two turn joint, if there is the keyboard, mouse reverse use;
4. Answer D: Replace one joint and two joints;
5. Answer E. Replace the mouse and keyboard.

Q5: Unable cannot boot the system from the hard drive after boot

1. Answer A: Press the "Del" key to enter the CMOS hard disk parameter setting and boot order are correct;
2. Answer B: After using the optical drive or floppy drive boot, check whether the hard disk has a boot system or the hard disk is normal partition and has activated the boot partition;
3. Answer C: Press F8 at startup and select the last correct configuration to start the operating system;
4. Answer D: Replace the new hard drive and reinstall the system.

Q6: The system dies or has a blue screen during operation

1. Answer A: Check whether the industrial computer temperature is too high;
2. Answer B: Check whether the incorrect or expired drivers are installed;
3. Answer C: Check whether the system is infected with the virus;
4. Answer D: Whether the system file or application and disk are damaged.

Q7: Unable to install the device driver correctly

1. Answer A: Check whether the driver is correct and the latest;
2. Answer B: Whether the driver needs the patch support of the operating system;
3. Answer C: Whether the resources occupied by other equipment are in conflict with the resources occupied by the equipment that need to be driven;
4. Answer D: If the peripheral equipment, change a slot and reinstall the drive;

5. Answer E: Replace the equipment and reinstall the driver program.

Q8: BIOS Upgrade method

1. Prepare a UEFI start U disk, if not, you need to make one;
2. Please copy the required refresh BIOS file and batch to the U disk root directory;
3. Press F7, select the made UEFI U disk, return, and enter the Shell;
4. Enter FS0: return (if no other storage devices, fs0:);
5. Run the flash. The nsh, brush BIOS, the middle of no power off;
6. After brushing the BIOS, power off, then power on, restart the industrial computer, enter the BIOS setting, F3 load the BIOS optimization value (Load optimized defaults return car selection Y).

Q9: Precautions The following conditions may lead to a refresh failure and no boot up.

1. Power interruption during the refresh process;
2. Virus exists in the U disk;
3. BIOS files;
4. Non-UEFI system.

If it cannot be started after refresh, you can empty the BIOS and try it. If the situation is still the same, please return to the factory for repair.

Chapter 8. After-Sale Service



Chapter 8. After-Sale Service

Please visit the official website of Darveen (www.darveen.com), Get the latest information on the product.

If users need technical support, please contact the local distributor, seller or the customer service department. Before the technical consultation, please collect the following information:

1. Product model and production serial number (normally, bar code on the body)
2. Software used (operating system, version, application software, etc.)
3. Additional equipment situation of product docking (such as power supply situation, resistance and other basic information)
4. Complete description of the problem (video and photo)
5. Full content of each error message (video recording and photo taking)



Darveen Co., Ltd.
Email: sales@darveen.com
www.darveen.com
Darveen Co., Ltd. All Rights Reserved